



FOREST DRAPERY HARDWARE

RETAIL PRICE GUIDE VOLUME 24

TABLE OF CONTENTS

TRACK SYSTEMS

CS Heavy Duty Track System	3-6
CM Heavy Duty Ceiling Mount Track System	3-6
CCS Heavy Duty Corded Track System.	7-8
RTS Recessed Track System	9-10
KS Light-Medium Duty Klick System	11-12
DS Design System.	11-12
DSXL Design System XL	13-14
DSXL LED Design System XL with LED Lighting	13-14
PS Panel System	15-16

ROLLERS & ROMANS

APOLLO Basic Roller Shades	19-20
MERCURY Decorative Roller Shades	21-26
ATLANTIS Motorized Heavy Duty Roller Shades	27-28
Roller Shade Fabric Options	29-30
RBS Roman Blind System - Cord Control	31-32
RBS Roman Blind System - Motorized	33-34
RBS XL Roman Blind System XL	35-36
BCS Motorized Blind Contract System	37-38

BENDING/CURVING, BATONS & WORKROOM

Bending & Curving	41-42
Batons.	43
Workroom Components.	44
FES Forest Easyflex System.	44

DECORATIVE METAL HARDWARE

TAVIRA 1 1/8" Pole Sets	47
TAVIRA 1 1/8" Traversig Sets.	48
GLASGOW 1 3/8" Acrylic Pole Sets.	49-50
DRESDEN 1 1/8" Pole Sets.	51-52
DEVENTER DECO 1 1/8" Pole Sets	53-54
LISBON 1 3/16" Pole Sets	55-56

AVEIRO 1 3/16" Pole Sets	57-58
PORTO 3/4" Wrought Iron Pole Sets.	59-60
PORTO 1 3/16" Wrought Iron Pole Sets	61-62
DRESDEN TRAVERSING 1 1/8"	63-64
DRESDEN CORDED 1 1/8"	65-66
DEVENTER CRS TRAVERSING 1 1/8"	67-68
FRANKFURT TRAVERSING 1" Square Rail.	69-70
PURE TRAVERSING	71-72
STUTTGART RECTANGLE RAIL	73-74
STUTTGART OVAL RAIL	75-76

DECORATIVE WOOD HARDWARE

VALENCIA 1 3/4" Pole Sets	79-80
SEVILLE 1 3/8" Pole Sets	81-82
CORDOBA 2" Pole Sets	83-84
GRANADA 2 3/4" Pole Sets.	85-86
CORDOBA 2" & GRANADA 2 3/4" Traversing	87-88

DRAPERY MOTORIZATION

SHUTTLE Motor Specifications.	91-92
INTEGRATION Roadmap	93-94
FMS Motorized Track System.	95-96
RMS Recessed Motorized System.	97-98
DSXL LED Motorized Design System + LED Lighting	99-100
PURE Contemporary Designer Profile.	101-102
DRESDEN Motorized Decorative Metal	103-106
DEVENTER MRS Motorized Decorative Metal	107-108
CORDOBA & GRANADA Motorized Wood.	109-110

APPENDIX

Terms and Conditions.	111
Ordering Instructions	112
Returns, Warranty & Care	112
Ripplefold Carrier Counts	113-114
Product Support	115-116
Child Safety	116

TRACKS SYSTEMS

CS | CM | CCS | RTS | KS | DS | DSXL | DSXL LED | PS



Scan for more information on FOREST Track Systems

TRACKS CS CM

CS[®] CONTRACT SYSTEM CM CEILING MOUNT TRACK

- Heavy duty aluminum extrusion, powder coated, and lubricated with a patented process.
- Maximum weight is 6 lbs/ft.
- CS track can be bent and curved. An exact size template is required. See pages 41-42 for more information.
- Hand or baton draw, one or two way.
- Stackback: Ripplefold - 6" per width, pinchpleat - 7" per width, cubicle - 5" per width.

ASSEMBLED PRICING

Includes track, masters, pinchpleat or ripplefold carriers, brackets, and 36" white fiberglass baton (See all batons page 43). Freight is additional.

	first 4 feet	ea. add'l foot
CS White	\$159.27	\$15.67
CS Black, Brown, Grey	\$175.19	\$17.23
CM White Only	\$138.53	\$11.49





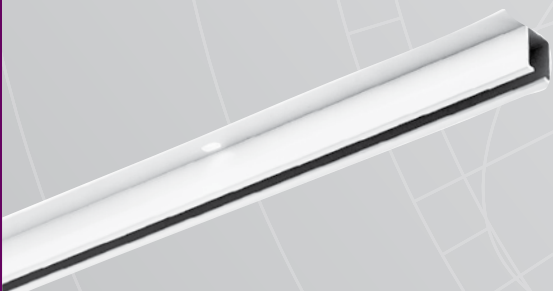
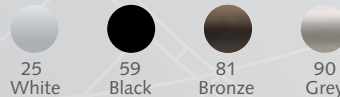



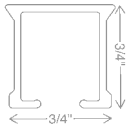
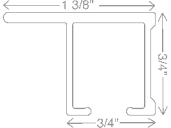
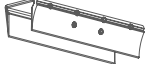

BATON OPTIONS

















Fiberglass batons in 36", 48", 60", 72", 84" and 96" lengths and these colors. See all batons page 43.

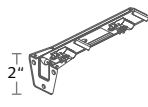

TRACKS SYSTEMS

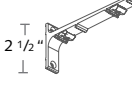
CS | CM | CCS | RTS | KS | DS | DSXL | DSXL LED | PS

CS	CM	COMPONENT	PRICE
•		 <p>CS Contract System Track 51012-25 white 12' 51014-25 white 14' 51016-25 white 16' 51020-25 white 20'</p> <p>51016-59 black 16' 51020-59 black 20' 51016-65 brown 16' 51016-90 grey 16'</p>	<p>\$4.68/ft. 20 tracks /bundle</p> <p>\$5.15/ft. 20 tracks /bundle</p>
	•	 <p>CM Ceiling Mount Track 51212-25 white 12' 51214-25 white 14' 51216-25 white 16' Holes every 16"</p>	<p>\$5.78/ft. 20 tracks/ bundle</p>
•		 <p>3906-25 59 black, 65 brown, 90 grey +10% Track Connector</p>	<p>\$20.37 ea. 10/box</p>
•	•	 <p>52304-25 59 black, 65 brown, 90 grey +10% End Cap - Short reduces light gap</p>	<p>\$3.92 ea.  \$3.26 ea. /box of 400</p>
•	•	 <p>52301-25 59 black, 65 brown, 90 grey +10% End Cap w/ Economy Slide Add 2004-25 w/ Ripplefold</p>	<p>\$1.43 ea.  \$1.19 ea. /box of 400</p>
•	•	 <p>52302-25 Right Return 52303-25 Left Return End Cap w/ Return Plate, Snap for pinch pleat or Ripplefold</p>	<p>\$2.72 ea.  \$2.27 ea. /box of 100</p>
•		 <p>9100-00 Channel Protector</p>	<p>\$17.72 ea.</p>
•		 <p>3001-25 59 black, 65 brown, 90 grey +10% Regular Duty Ceiling Bracket</p>	<p>\$1.56 ea.  \$1.28 ea. /box of 100</p>

CS	CM	COMPONENT	PRICE
•		 <p>3901-25 59 black, 65 brown, 90 grey +10% Ceiling Splice/Bracket</p>	<p>\$2.65 ea.  \$2.20 ea. /box of 50</p>
•		 <p>3003-25 59 black, 65 brown, 90 grey +10% Heavy Duty Ceiling Bracket w/ Smart Klick</p>	<p>\$2.65 ea.  \$2.19 ea. /box of 100</p>
•		 <p>30031-25 59 black, 65 brown, 90 grey +10% Ceiling Bracket Cover use with 3003-XX</p>	<p>\$1.10 ea.  \$0.92 ea. /box of 100</p>
•		 <p>53202-25 59 black, 65 brown, 90 grey +10% 3" Smart Klick Wall Bracket w/ wide base, adjusts 3-4.5"</p>	<p>\$6.34 ea.  \$5.28 ea. /box of 100</p>
•		 <p>53206-25 59 black, 65 brown, 90 grey +10% 6" Smart Klick Double Wall Bracket w/ wide base adjusts 2.5"-4" & 6"-7.5"</p>	<p>\$11.16 ea.  \$9.30 ea. /box of 50</p>
•		 <p>3280-25 59 black, 65 brown, 90 grey +10% 3" Wall Bracket, heavy duty projection 2 1/2"</p>	<p>\$14.58 ea.  \$12.15 ea. /box of 20</p>
•		 <p>3281-25 59 black, 65 brown, 90 grey +10% 6" Double Wall Bracket, heavy duty projection 1 1/2", 5 1/2"</p>	<p>\$20.90 ea.  \$17.41 ea. /box of 15</p>
•		 <p>32801-25 59 black, 90 grey +10% Wall Bracket Cover use with 3280 & 3281</p>	<p>\$3.76 ea.  \$3.13 ea. /box of 50</p>











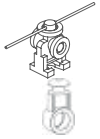



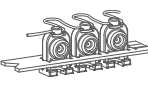













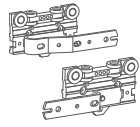

 BREAK PACK PRICING  - Prices with this designation indicate a 20% up charge for broken pack quantities.

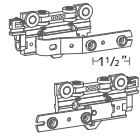
TRACKS CS CM

TRACKS SYSTEMS

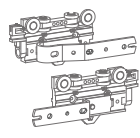
CS | CM | CCS | RTS | KS | DS | DSXL | DSXL LED | PS

TRACKS CS CM

CS	CM	COMPONENT	PRICE	CS	CM	COMPONENT	PRICE
•	•	 <p>Wheeled Connected Snap Carrier in plastic sleeve 2107-25, 59 black 60% fullness, 2 5/8" OC 2106-25, 59 black 65 brown, 90 grey 80% fullness, 2 3/8" OC 2105-25, 59 black 100% fullness, 2 1/8" OC 2108-25, 59 black 120% fullness, 1 7/8" OC</p>	\$1.83 ea.  \$1.52 ea. /roll of 500 Colors other than white +10%	•	•	 <p>52003-25 59 black, 65 brown + 10% Economy Slide</p>	\$0.35 ea.  \$0.29 ea. /box of 2000
•	•	 <p>Wheeled Connected Snap Carrier on plastic strip 2207-25 60% fullness, 2 5/8" OC 2206-25, 59, 65, 90 80% fullness, 2 3/8" OC 2205-25 100% fullness, 2 1/8" OC 2208-25 120% fullness, 1 7/8" OC</p>	\$2.37 ea.  \$1.98 ea. /box of 500 Colors other than white +10%	•	•	 <p>52100-25, 24 gold, 59 black, 65 brown, 90 grey Ball Bearing Carrier w/ Stainless Hook slim line - use w/ grommets</p>	\$2.24 ea.  \$1.86 ea. /box of 1000 Colors other than white +10%
•	•	 <p>2007-25 59 black + 10% Pendant Only, for 2100 Carriers</p>	\$0.26 ea.  \$0.22 ea. /bag of 500	•	•	 <p>52005-25 Button Slide Carrier</p>	\$0.28 ea.  \$0.24 ea. /box of 1000
•	•	 <p>2008-25 59 black, 65 brown, 90 grey + 10% Pendant Only, for 2200 Carriers</p>	\$0.24 ea.  \$0.21 ea. /bag of 500	•	•	 <p>52105-25 Button Slide Carrier w/ Hook</p>	\$0.87 ea.  \$0.73 ea. /box of 500
•	•	 <p>2004-25 24 gold, 59 black, 65 brown, 90 grey + 10% Snap Carrier for accordiafold</p>	\$0.67 ea.  \$0.57 ea. /bag of 500	•	•	 <p>52502-25 Overlap R 52504-25 Underlap L 59 black + 10% Standard Multi-Functional Master Use stiffener w/ exposed baton or hooks w/ hidden baton</p>	\$8.80 ea.  \$7.34 ea. /box of 100
•	•	 <p>52002-25 24 gold, 59 black, 65 brown, 90 grey + 10% Slim Line Ball Bearing Carrier</p>	\$0.82 ea.  \$0.67 ea. /box of 1000	•	•	 <p>52502-25A Overlap R 52504-25A Underlap L 59A black + 10% Standard Multi-Functional Master w/ snaps and baton adaptor</p>	\$10.66 ea.  \$8.89 ea. /box of 100
•	•	 <p>52008-25 59 black, 65 brown + 10% Slim Line Klick Carrier draperies hang to conceal track</p>	\$1.31 ea.  \$1.08 ea. /box of 250	•	•	 <p>52502-25B Overlap R 52504-25B Underlap L Standard Multi-Functional w/ baton adaptor for stiffener. Stainless steel for outdoor use.</p>	\$8.80 ea.  \$7.34 ea. /box of 50
•	•	 <p>52108-25 Stop Carrier prevents slide back</p>	\$2.65 ea.  \$2.20 ea. /box of 100				

 BREAK PACK PRICING  - Prices with this designation indicate a 20% up charge for broken pack quantities.

TRACKS SYSTEMS

CS | CM | CCS | RTS | KS | DS | DSXL | DSXL LED | PS

CS	CM	COMPONENT	PRICE	CS	CM	COMPONENT	PRICE
•	•	 <p>52508-25 Overlap R 52509-25 Underlap L 59 black, 65 brown + 10% Swivel Foot Multi-Functional Master for bends and curves</p>	<p>\$15.51 ea. </p> <p>\$12.95 ea. /box of 100</p>	•	•	 <p>52601-25A Overlap R 52603-25A Underlap L Extended Spacing Master w/ snaps and adaptor</p>	<p>\$7.13 ea. </p> <p>\$5.94 ea. /box of 100</p>
•	•	 <p>52508-25A Overlap R 52509-25A Underlap L 59 black, 65 brown + 10% Swivel Foot Multi-Functional Master w/ snaps</p>	<p>\$18.39 ea. </p> <p>\$15.33 ea. /box of 100</p>	•	•	 <p>2552-25 6" Extension Arm for master Use w/ two one-way draws</p>	<p>\$14.42 ea. </p> <p>\$12.03 ea. /box of 50</p>
•	•	 <p>52501-25 Overlap R 52503-25 Underlap L Stiffener Master</p>	<p>\$8.80 ea. </p> <p>\$7.34 ea. /box of 50</p>	•	•	 <p>2551-25 Small Extension Arm</p>	<p>\$5.24 ea. </p> <p>\$4.35 ea. /box of 50</p>
•	•	 <p>52401-25 Overlap R 52403-25 Underlap L Stiffener Master w/ snaps and adaptor</p>	<p>\$10.79 ea. </p> <p>\$8.99 ea. /box of 50</p>	•	•	 <p>2305-25 59 black, 65 brown, 90 grey + 10% Twist On End Stop</p>	<p>\$2.65 ea. </p> <p>\$2.20 ea. /box of 100</p>
•	•	 <p>52410-25 Butt R 52409-25 Butt L 59 black + 10% Standard Butt Master w/ snaps and for baton use</p>	<p>\$21.38 ea. </p> <p>\$17.80 ea. /box of 50</p>	•	•	 <p>2308-25 Return Plate reversible, 2 1/2" return</p>	<p>\$9.98 ea. </p> <p>\$8.33 ea. /box of 100</p>
•	•	 <p>52411-25A Butt R 52412-25A Butt L 24A gold, 59A black, 65A brown, 90A grey + 10% Wheeled Butt Master w/snap adaptor Designed for hidden baton</p>	<p>\$37.74 ea. </p> <p>\$31.44 ea. /box of 50</p>	•	•	 <p>52307-90 End Lock</p>	<p>\$1.18 ea. </p> <p>\$0.98 ea. /box of 100</p>
•	•	 <p>52514-25 Overhead R 52515-25 Underhead L Over the Top Baton Master Designed for exposed baton</p>	<p>\$14.34 ea. </p> <p>\$11.93 ea. /box of 100</p>	•	•	 <p>54110-25 36" Fiberglass Baton w/ snap</p>	<p>\$9.26 ea. </p> <p>\$7.72 ea. /box of 100 See all batons page 43</p>

 BREAK PACK PRICING  - Prices with this designation indicate a 20% up charge for broken pack quantities.

TRACKS SYSTEMS

CS | CM | **CCS** | RTS | KS | DS | DSXL | DSXL LED | PS



Scan for more information on the FOREST CCS Contract Cord System

CCS® CONTRACT CORD SYSTEM

- Aluminum extrusion, powder coated and lubricated with a patented process.
- Maximum weight is 50 lbs per system.
- Bendable – CCS Track can be bent and curved. An exact size template is required. See pages 41-42 for more information.
- Cord draw, one or two way. Bead chain also available.
- Stackback: Ripplefold - 6" per width, pinchpleat - 7" per width, accordiafold - 5" per width.
- All Forest corded products include a child safety tension device and warning label.

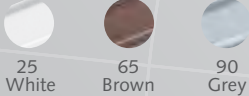







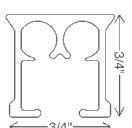

ASSEMBLED PRICING

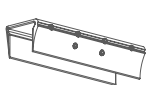
Includes track, masters, pinchpleat or ripplefold carriers, brackets, cord, tension pulley, child safety device. Freight is additional.

CCS CONTRACT SYSTEM	first 4 feet	ea. add'l foot
White	\$245.41	\$20.93
Brown, Grey	\$269.95	\$23.02

TRACKS CCS

CCS	COMPONENT	PRICE	CCS	COMPONENT	PRICE
•	 <p>CCS Contract Cord Track 20 tracks/bundle 51116-25 white 16' 51116-65 brown 16' 51116-90 grey 16'</p>	<p>\$6.08/ft. \$6.69/ft. \$6.69/ft.</p>	•	 <p>52801-25A Right 52801-25B Left End Pulley w/ Snap 2 1/4" Reversible, for Ripplefold</p>	<p>\$14.70 ea.  \$12.24 ea. /box 25</p>
•	 <p>3906-25 59 black, 65 brown, 90 grey +10% Track Connector</p>	<p>\$20.37 ea. 10/box</p>	•	 <p>52803-25 65 brown, 90 grey +10% Small End Pulley 1 1/2" Reversible, use with Butt Masters and one-way draw</p>	<p>\$13.51 ea.  \$11.26 ea. /box 25</p>
•	 <p>52801-25 65 brown, 90 grey +10% End Pulley, 2 1/4" Reversible Use on right or left</p>	<p>\$13.51 ea.  \$11.26 ea. /box 25</p>	•	 <p>3001-25 59 black, 65 brown, 90 grey +10% Regular Duty Ceiling Bracket</p>	<p>\$13.56 ea.  \$1.28 ea. /box of 100</p>

TRACKS SYSTEMS

CS | CM | **CCS** | RTS | KS | DS | DSXL | DSXL LED | PS

CCS	COMPONENT	PRICE	CCS	COMPONENT	PRICE
●	 3003-25 59 black, 65 brown, 90 grey +10% Heavy Duty Ceiling Bracket w/ Smart Klick	\$2.65 ea.  \$2.19 ea. /box of 100	●	 52008-25 59 black, 65 brown + 10% Slim Line Klick Carrier draperies hang to conceal track	\$1.31 ea.  \$1.08 ea. /box of 250
●	 30031-25 59 black, 65 brown, 90 grey +10% Ceiling Bracket Cover use with 3003-XX	\$1.10 ea.  \$0.92 ea. /box of 100	●	 52004-25 Low Profile Ball Bearing	\$1.84 ea.  \$1.51 ea. /box of 1000
●	 53202-25 59 black, 65 brown, 90 grey +10% 3" Smart Klick Wall Bracket w/ wide base, adjusts 3-4.5"	\$6.34 ea.  \$5.28 ea. /box of 100	●	 52508-25 Overlap R 52509-25 Underlap L 59 black, 65 brown + 10% Swivel Foot Multi-Functional Master for bends and curves	\$15.51 ea.  \$12.95 ea. /box of 100
●	 53206-25 59 black, 65 brown, 90 grey +10% 6" Smart Klick Double Wall Bracket w/ wide base adjusts 2.5"-4" & 6"-7.5"	\$11.16 ea.  \$9.30 ea. /box of 50	●	 52508-25A Overlap R 52509-25A Underlap L 59 black, 65 brown + 10% Swivel Foot Multi-Functional Master w/ snaps	\$18.39 ea.  \$15.33 ea. /box of 100
●	 3280-25 59 black, 65 brown, 90 grey +10% 3" Wall Bracket, heavy duty projection 2 1/2"	\$14.58 ea.  \$12.15 ea. /box of 20	●	 52410-25 Butt R 52409-25 Butt L 59 black + 10% Standard Butt Master w/ snaps for baton use	\$21.38 ea.  \$17.80 ea. /box of 50
●	 3281-25 59 black, 65 brown, 90 grey +10% 6" Double Wall Bracket, heavy duty projection 1 1/2", 5 1/2"	\$20.90 ea.  \$17.41 ea. /box of 15	●	 52804-25 CCS Return Insert with snap or hook	\$7.33 ea.  \$6.11 ea. /box of 100
●	 32801-25 59 black, 90 grey +10% Wall Bracket Cover use with 3280 & 3281	\$3.76 ea.  \$3.13 ea. /box of 50	●	 52510-25 59 black, 65 brown, 90 grey +10% Cord Connector	\$2.86 ea.  \$2.38 ea. /box of 100
●	Two Piece Connected Snap Carrier w/ Square Base, in plastic sleeve. Use 1 1/4" snap tape 2114-25, 59 black 60% fullness, 2 5/8" OC 2111-25, 59 black, 65 brown, 90 grey 80% fullness, 2 3/8" OC 2112-25, 59 black 100% fullness, 2 1/8" OC 2115-25, 59 black 120% fullness, 1 7/8" OC	\$1.47 ea.  \$1.23 ea. /roll of 500 Colors other than white +10%	●	 2305-25 65 brown, 90 grey +10% Twist On End Stop use with curved tracks	\$2.65 ea.  \$2.20 ea. /box of 100
			●	 9004-25 3.2mm Cord 333.34 yds./roll	\$2.46/yd.  \$820.28/roll
			●	 49501-00 Tension Device For child safety	\$10.32 ea.  \$8.59 ea. /box of 250

 BREAK PACK PRICING  - Prices with this designation indicate a 20% up charge for broken pack quantities.

TRACKS SYSTEMS

CS | CM | CCS | **RTS** | KS | DS | DSXL | DSXL LED | PS

TRACKS RECESSED



Scan for more information on the FOREST RTS Recessed Track System



RTS RECESSED TRACK SYSTEM

- Heavy duty aluminum extrusion, white, powder coated and lubricated with a patented process.
- Maximum weight is 8 lbs/ft.
- Cannot be spliced
- Hand or baton draw, one or two way.
- Stackback: Ripplefold - 6" per width, pinchpleat - 7" per width, cubicle - 5" per width.

ASSEMBLED PRICING

Includes track, masters, pinchpleat or ripplefold carriers, recess profile, fixing strip, wedge, and 36" white fiberglass baton (See all batons page 43). Freight is additional.

RTS RECESSED TRACK	first 4 feet	ea. add'l foot
White	\$261.96	\$34.33

BATON OPTIONS

Fiberglass batons in 36", 48", 60", 72", 84" and 96" lengths and these colors. See all batons page 43.

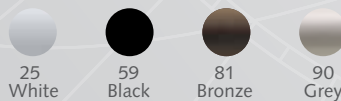











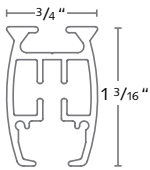

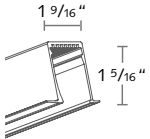



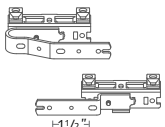

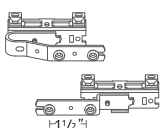

25
White

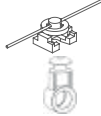

MOTOR CONTROL
P. 97-98

TRACKS SYSTEMS

CS | CM | CCS | **RTS** | KS | DS | DSXL | DSXL LED | PS

RTS	COMPONENT	PRICE	RTS	COMPONENT	PRICE
●	 <p>51623-25 RTS Track white 19' x 10 tracks/bundle bundle = 190' Cannot be spliced</p>	\$14.86/ft.	●	 <p>52008-25 Slim Line Klick Carrier Allows drapery to hang and conceal track</p>	\$1.31 ea.  \$1.08 ea. /box of 250
●	 <p>51723-25 Recess Profile, 23' Order same length as track</p>	\$19.66/ft.	●	 <p>52009-25 Ball Bearing Carrier for motorization</p>	\$1.84 ea.  \$1.51 ea. /box of 250
●	 <p>51724-25 Recess Profile Fixing Strip, 23' Order 6" shorter than track</p>	\$4.13/ft.	●	 <p>52508-25 Overlap R 52509-25 Underlap L Swivel Foot Multi-Functional Master</p>	\$15.51 ea.  \$12.95 ea. /box of 100
●	 <p>53914-25 Recess Profile Wedge Order 1 per track</p>	\$5.80 ea.  \$4.58 ea. /box of 10	●	 <p>52508-25A Overlap R 52509-25A Underlap L Swivel Foot Multi-Functional Master w/ snaps</p>	\$18.39 ea.  \$15.33 ea. /box of 100
●	 <p>3801-25 RTS End Cap</p>	\$7.67 ea.  \$6.39 ea. /box of 200	●	 <p>52410-25 Butt R 52409-25 Butt L Standard Butt Master w/ 3 snaps for baton use</p>	\$21.38 ea.  \$17.80 ea. /box of 50
●	 <p>Two Piece Connected Snap Carrier w/ Square Base, in plastic sleeve. Use 1 1/4" snap tape 2114-25, 59 black 60% fullness, 2 5/8" OC 2111-25, 65 brown, 90 grey 80% fullness, 2 3/8" OC 2112-25, 59 black 100% fullness, 2 1/8" OC 2115-25, 59 black 120% fullness, 1 7/8" OC</p>	\$1.47 ea.  \$1.23 ea. /roll of 500 Colors other than white +10%	●	 <p>54110-25 36" Fiberglass Baton w/ snap</p>	\$9.26 ea.  \$7.72 ea. /box of 100 See all batons page 43

 BREAK PACK PRICING  - Prices with this designation indicate a 20% up charge for broken pack quantities.

TRACKS SYSTEMS

CS | CM | CCS | RTS | **KS** | **DS** | DSXL | DSXL LED | PS



Scan for more information on the FOREST Track Systems

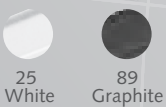

KS® KLIK SYSTEM DS® DESIGN SYSTEM

- Aluminum extrusion, powder coated and lubricated with a patented process.
- Maximum weight is 3 lbs/ft.
- Bendable – KS & DS tracks can be bent and curved. An exact size template is required. See pages 41-42 for more information.
- Hand or baton draw, one or two way.
- Stackback: ripplefold - 6" per width, pinchpleat - 7" per width, cubicle - 5" per width, accordiafold - 5" per width.

ASSEMBLED PRICING

Includes track, masters, pinchpleat or ripplefold carriers, brackets, and 36" white fiberglass baton (See all batons page 43). Freight is additional.

	first 4 feet	ea. add'l foot
KS Track White	\$137.31	\$15.95
KS Track Black, Brown, Grey	\$151.04	\$17.55
DS Track White	\$191.12	\$18.80
DS Track Graphite	\$210.23	\$20.68

BATON OPTIONS

Fiberglass batons in 36", 48", 60", 72", 84" and 96" lengths and these colors. See all batons page 43.

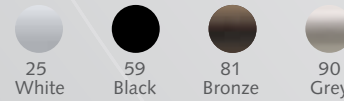







TRACKS KS DS





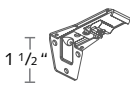
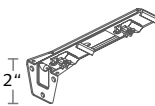
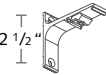



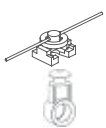

KS	DS	COMPONENT	PRICE
•		<p>KS Klick System Track 1013-25 white 13' 1" 1016-25 white 16' 4" 1019-25 white 19' 8"</p> <p>1016-59 black 16' 4" 1016-65 brown 16' 4" 1016-90 grey 16' 4"</p>	\$4.82/ft. 20 tracks /bundle
	•	<p>DS Design System Track 1116-25 white 16' 4" 89 graphite +10%</p>	\$7.45/ft. 20 tracks /bundle
•	•	<p>3905-25 59 black, 65 brown, 90 grey +10% Track Connector, key 3904-00</p>	\$12.05 ea. \$10.05 ea. /box 50
•		<p>2309-25 59 black, 65 brown, 90 grey KS End Cap Multifunctional</p>	\$1.50 ea. \$1.24 ea. /box 100

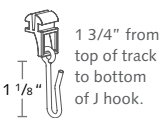
KS	DS	COMPONENT	PRICE
•		<p>2309-255 59S black, 90S grey KS End Cap Short reduces light gap</p>	\$1.34 ea. \$1.11 ea. /box 100 Colors + 10%
	•	<p>2310-25 89 graphite DS End Cap w/ screw</p>	\$2.53 ea. \$2.12 ea. /box 10 Colors + 10%
•	•	<p>9100-00 Channel Protector</p>	\$17.72 ea.
•	•	<p>3001-25 59 black, 65 brown, 90 grey Regular Duty Ceiling Bracket</p>	\$1.56 ea. \$1.28 ea. /box 100 Colors +10%
•	•	<p>3901-25 59 black, 65 brown, 90 grey Ceiling Splice/Bracket</p>	\$2.65 ea. \$2.20 ea. /box 50 Colors +10%

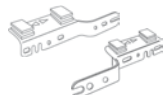
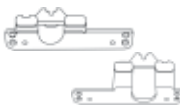
TRACKS SYSTEMS

CS | CM | CCS | RTS | **KS** | **DS** | DSXL | DSXL LED | PS

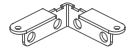
KS	DS	COMPONENT	PRICE
•	•	 3003-25 59 black, 65 brown, 90 grey +10% Heavy Duty Ceiling Bracket w/ Smart Klick	\$2.65 ea. \$2.19 ea. /box of 100
•	•	 30031-25 59 black, 65 brown, 90 grey +10% Ceiling Bracket Cover use with 3003-XX	\$1.10 ea. \$0.92 ea. /box of 100
•	•	 53202-25 59 black, 65 brown, 90 grey +10% 3" Smart Klick Wall Bracket w/ wide base, adjusts 3-4.5"	\$6.34 ea. \$5.28 ea. /box of 100
•	•	 53206-25 59 black, 65 brown, 90 grey +10% 6" Smart Klick Double Wall Bracket w/ wide base adjusts 2.5"-4" & 6"-7.5"	\$11.16 ea. \$9.30 ea. /box of 50
•	•	 3280-25 59 black, 65 brown, 90 grey +10% 3" Wall Bracket, heavy duty projection 2 1/2"	\$14.58 ea. \$12.15 ea. /box of 20
•	•	 3281-25 59 black, 65 brown, 90 grey +10% 6" Double Wall Bracket, heavy duty projection 1 1/2", 5 1/2"	\$20.90 ea. \$17.41 ea. /box of 15
•	•	 32801-25 59 black, 90 grey +10% Wall Bracket Cover use with 3280 & 3281	\$3.76 ea. \$3.13 ea. /box of 50
•	•	 2001-25 59 black, 65 brown, 90 grey +10% Klick Carrier, for pinch pleat	\$0.67 ea. \$0.57 ea. /box of 500
•	•	 2002-25 59 black, 65 brown, 90 grey +10% Shirrtape Carrier	\$0.65 ea. \$0.54 ea. /box of 500
•	•	 2004-25 59 black +10% Snap Carrier, for accordiafold	\$0.67 ea. \$0.57 ea. /box of 500
•	•	 Two Piece Connected Snap Carrier w/ Square Base, in plastic sleeve. Use 1 1/4" snap tape 2114-25, 59 black 60% fullness, 2 5/8" OC 2111-25, 65 brown, 90 grey 80% fullness, 2 3/8" OC 2112-25, 59 black 100% fullness, 2 1/8" OC 2115-25, 59 black 120% fullness, 1 7/8" OC	\$1.47 ea. \$1.23 ea. /roll of 500 Colors other than white +10%

KS	DS	COMPONENT	PRICE
•	•	 52003-25 65 brown +10% Economy Slide	\$0.35 ea. \$0.29 ea. /box of 2000
•	•	 52004-25 Low Profile Ball Bearing Carrier	\$1.84 ea. \$1.51 ea. /box of 1000
•	•	 2201-25 59 black +10% Klick Carrier w/ Stainless Hook Use with grommets 1 3/4" from top of track to bottom of J hook. 1 1/8"	\$1.78 ea. \$1.47 ea. /box of 100
•	•	 52005-25 Button Slide Carrier	\$0.28 ea. \$0.24 ea. /box of 1000
•	•	 52105-25 Button Slide Carrier w/ Hook	\$0.87 ea. \$0.73 ea. /bag of 500
•	•	 2525-25 Overlap R 2526-25 Underlap L 65 brown +10% Pinchpleat Master 2527-25 Overlap L 2528-25 Underlap R	\$15.46 ea. \$12.86 ea. /box of 25
•	•	 B8809-23-00 Overlap R B8809-24-00 Underlap L 59 black +10% Plastic Snap Master	\$15.46 ea. \$12.86 ea. /box of 25
•	•	 52410-25 Butt R 52409-25 Butt L 59 black +10% Standard Butt Master w/ snaps and for baton use	\$21.38 ea. \$17.80 ea. /box of 50
•	•	 2305-25 59 black, 65 brown, 90 grey +10% Twist On End Stop	\$2.65 ea. \$2.20 ea. /box of 100
•	•	 52307-90 End Lock	\$1.18 ea. \$0.98 ea. /box of 100
•	•	 2308-25 Return Plate reversible, 2 1/2" return	\$9.98 ea. \$8.33 ea. /box of 100
•	•	 54110-25 36" Fiberglass Baton w/ snap See all batons p. 43	\$9.26 ea. \$7.72 ea. /box of 100

BREAK PACK PRICING - Prices with this designation indicate a 20% up charge for broken pack quantities.

TRACKS SYSTEMS

CS | CM | CCS | RTS | KS | DS | **DSXL | DSXL LED** | PS

TRACKS DSXL / DSXL LED

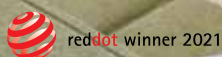

Scan for more information on the FOREST DSXL Design System XL

DSXL® DESIGN SYSTEM DSXL® LED DESIGN SYSTEM + LED LIGHTING

- Elegantly shaped aluminum extrusion, white, powder coated and lubricated with a patented process. LED lighting lights up the backside of drapery or the track itself.
- LED strips have low energy consumption, are eco-friendly, dimmable. Lifespan is 30,000 hours.
- Maximum weight is 3 lbs/ft.
- Hand or baton draw, one or two way. DSXL LED can also be motorized. See pages 99-100.
- Stackback: Ripplefold - 6" per width, pinchpleat - 7" per width, cubicle - 5" per width, accordiafold - 5" per width.

ASSEMBLED PRICING

Includes track, masters, pinchpleat or ripplefold carriers, wall or ceiling brackets, lighting components (if specified), and 36" white fiberglass baton (See all batons page 43). Freight is additional.

DESIGN SYSTEM XL	first 4 feet	ea. add'l foot
DSXL	\$299.72	\$41.45
DSXL LED	\$2,227.26	\$130.26

BATON OPTIONS

Fiberglass batons in 36", 48", 60", 72", 84" and 96" lengths and these colors. See all batons page 43.

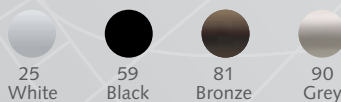

25
White



MOTOR CONTROL
P. 99-100

TRACKS SYSTEMS

CS | CM | CCS | RTS | KS | DS | **DSXL** | **DSXL LED** | PS

DSXL	DSXL LED	COMPONENT	PRICE	DSXL	DSXL LED	COMPONENT	PRICE
●		 <p>2119-25 DSXL Track 19' 8" x 20 tracks per bundle bundle = 393.7' cannot be spliced</p>	\$16.02/ft.	●		 <p>B8809-23-00 Overlap R B8809-24-00 Underlap L Plastic Snap Master</p>	\$15.45 ea.  \$12.86 ea. /box of 25
●		 <p>3119-25 DSXL LED Track 19' 8" x 20 tracks per bundle bundle = 393.7' cannot be spliced</p>	\$17.39/ft.	●		 <p>9040-25 FES Butt Master</p>	\$6.22 ea.  \$5.18 ea. /box of 25
●		 <p>2400-25 DSXL End Cap</p>	\$2.89 ea. \$2.42 ea. /box of 20	●		 <p>3000-00 LED Strip, 3000k/24v 30,000 hr lifespan Dimmable</p>	\$70.26 ea. /19' strip \$3.70/ft.
●		 <p>3400-25 DSXL LED End Cap</p>	\$2.63 ea.  \$2.19 ea. /box of 20	●		 <p>3010-00 LED Strip, middle</p>	\$72.04 ea. /19' strip \$3.79/ft.
●		 <p>3402-25 DSXL LED Flat End Cap</p>	\$2.63 ea.  \$2.19 ea. /box of 20	●		 <p>3030-00 Mounting Device for LED Strip</p>	\$355.60 ea.
●	●	 <p>43003-25 DSXL Swivel Ceiling Bracket</p>	\$3.11 ea.  \$2.59 ea. /box of 100	●		 <p>Power Supply, 24 volt 52928-25 with 7' 6" cord 52934-25 with 16' cord</p>	\$173.52 ea. \$173.52 ea. 1/box
●	●	 <p>2301-25 DSXL Wall Bracket w/ Swivel</p>	\$51.32 ea.  \$42.79 ea. /box of 5	●		 <p>3103-25 LED Dimmer Allows control of light strip with Diamond remote.</p>	\$287.39 ea. 1/box
●	●	 <p>Two Piece Connected Snap Carrier w/ Square Base, in plastic sleeve. Use 1 1/4" snap tape 2114-25, 59 black 60% fullness, 2 5/8" OC 2111-25, 65 brown, 90 grey 80% fullness, 2 3/8" OC 2112-25, 59 black 100% fullness, 2 1/8" OC 2115-25, 59 black 120% fullness, 1 7/8" OC</p>	\$1.47 ea.  \$1.23 ea. /roll of 500 Colors other than white +10%	●		 <p>Cable for LED Strip 3045 Power Supply, 24 volt Dimmer accessory 3100-00 with 6' 6" cord 3105-25 with 13" cord</p>	\$35.02 ea. \$28.47 ea. 1/box
●	●	 <p>2001-25 Klick Carrier for PP</p>	\$0.67 ea.  \$0.57 ea. /box of 500	●		 <p>3106-25 Extension Cable for LED Strip 3045, 6' 6" Dimmer accessory</p>	\$31.63 ea. 1/box
●	●	 <p>2201-25 Klick Carrier w/ Hook</p> <p>1 3/4" from top of track to bottom of J hook. 1 1/8"</p>	\$1.78 ea.  \$1.47 ea. /box of 100	●		 <p>52931-25D white 59D black +10% Diamond Sense Remote RF, 15 channel w/ holder, Range 98'</p>	\$434.19 ea. 1/box

 **BREAK PACK PRICING**  - Prices with this designation indicate a 20% up charge for broken pack quantities.

TRACKS SYSTEMS

CS | CM | CCS | RTS | KS | DS | DSXL | DSXL LED | PS

TRACKS PANEL SYSTEM



Scan for more information on the FOREST PS Panel System

PS® PANEL SYSTEM

- Aluminum extrusion, powder coated.
- Maximum weight is 10 lbs/panel.
- Hand or baton draw, one or two way.
- 2, 3, 4, or 5 channel systems available.

ASSEMBLED PRICING

Includes panel track, velcro profile with hook tape, wheeled carriers, brackets, and 36" white fiberglass baton (See all batons page 43). Freight is additional.

PS PANEL SYSTEM	first 4 feet	ea. add'l foot
2 Channel	\$224.35	\$35.37
3 Channel	\$253.90	\$41.77
4 Channel	\$298.92	\$50.29
5 Channel	\$347.65	\$55.25

BATON OPTIONS

Fiberglass batons in 36", 48", 60", 72", 84" and 96" lengths and these colors. See all batons page 43.



25
White



59
Black



81
Bronze



90
Grey

TRACKS SYSTEMS

CS | CM | CCS | RTS | KS | DS | DSXL | DSXL LED | **PS**

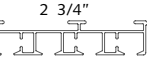
PS	COMPONENT	PRICE	PS	COMPONENT	PRICE
●	 5/8" 1 1/2"	PS Panel System Track	●	 5/8" 2"	31219-25 2 channel \$7.62/ft.
	 5/8" 2"	31319-25 3 channel \$9.57/ft.		 5/8" 2 3/4"	31419-25 4 channel \$12.82/ft.
	 5/8" 2 3/4"	31519-25 5 channel \$15.33/ft.		 5/8" 3 1/2"	19' x 5 tracks/bundle bundle = 95'
	 5/8" 3 1/2"				
●		32310-25 2-Channel End Cap Requires end cap cover \$1.25 ea.  \$1.06 ea.  /box of 500	●		32308-25 Stationary Set Screw locks side panel in place \$0.64 ea.  \$0.54 ea.  /box of 500
●		32312-25 2-Channel Cover for End Cap & Pulley \$0.75 ea.  \$0.61 ea.  /box of 600	●		33003-25 Swivel Ceiling Bracket for 2, 3 & 4 Channel \$1.30 ea.  \$1.08 ea.  /box of 200
●		32311-25 3, 4, 5-Channel End Cap Requires end cap cover \$2.04 ea.  \$1.70 ea.  /box of 300	●		Klick On Ceiling Bracket/Splice 33002-25 2, 3 & 4 Channel \$1.64 ea.  \$1.37 ea.  /box of 200
●		32309-25 3, 4 & 5-Channel Cover for End Cap & Pulley \$1.30 ea.  \$1.08 ea.  /box of 600	●		33004-25 5 Channel \$2.44 ea.  \$2.02 ea.  /box of 200
●		31116-25 Velcro Profile w/ Hook Tape, 13.1' \$5.72/ft.  \$4.75/ft.  /bundle 20	●		Wall Bracket 33005-25 2, 3 & 4 Channel \$3.96 ea.  \$3.30 ea.  /box of 200
●		32007-25 Wheeled Carrier connects profile to track \$1.68 ea.  \$1.41 ea.  /box of 500	●		33006-25 5 Channel \$4.85 ea.  \$4.04 ea.  /box of 200
●		32510-25 Baton Adaptor use on leading panel \$1.58 ea.  \$1.30 ea.  /box of 500	●		39007-25 Velcro Tape 27 yds. per roll \$34.21/roll
●		33202-25 Catcher, T-Angle for all panels except stationary panel \$0.75 ea.  \$0.61 ea.  /box of 500	●		54110-25 36" Fiberglass Baton w/ snap \$9.26 ea.  \$7.72 ea.  /box of 100 See all batons page 43

 BREAK PACK PRICING  - Prices with this designation indicate a 20% up charge for broken pack quantities.



ROLLER Shades & Romans

APOLLO BASIC ROLLER SHADES

Cassette and Direct

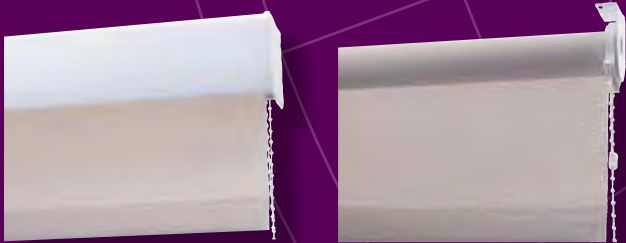

MERCURY DECORATIVE ROLLER SHADES

Fascia Double, Semi Open, and Direct



**SPRING
CONTROL
AVAILABLE**



**MOTOR
CONTROL
AVAILABLE**



Forest Roller Shades and Romans are high quality for residential or commercial use. Choose a fabric from our stock program and your roller shades ship in 10-14 business days.

ATLANTIS ROLLER SHADES

Heavy Duty Motorized



RBS & RBS XL

Roman Blind Systems

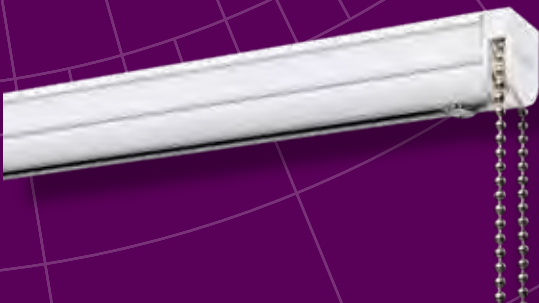

MOTOR
CONTROL
AVAILABLE

BCS[®] BLIND CONTRACT SYSTEM

Motorized Roman Blind System



ROLLER SHADES & ROMANS

APOLLO BASIC | MERCURY DECORATIVE | ATLANTIS HEAVY DUTY | ROLLER SHADE FABRIC OPTIONS | RBS | RBS XL | BCS



Scan for more information on FOREST Apollo Basic Roller Shades

APOLLO CASSETTE & DIRECT MOUNT

- Wall or ceiling mount for residential or contract use
- Maximum weight is 8 lbs. 13 oz.
- 1 1/2" / 38mm tube and a bi-directional clutch

CASSETTE MOUNT ASSEMBLED PRICING

Includes Essentials fabric (see pages 29-30 for all fabric options), 38mm tube, roller mechanisms, brackets, bracket covers, valance, bottom rail with end caps, and child safety device. Designer fabrics +20%. Exclusive fabrics +40%. Side channels are additional. Freight is additional.

LENGTH	WIDTH							
	24"	36"	48"	60"	72"	84"	96"	108"
24"	\$300.18	\$326.91	\$353.64	\$380.38	\$407.11	\$433.84	\$460.56	\$487.29
36"	\$365.65	\$392.38	\$419.11	\$445.84	\$472.57	\$499.30	\$526.03	\$552.76
48"	\$431.11	\$457.84	\$484.57	\$511.31	\$538.04	\$564.77	\$591.50	\$618.23
60"	\$496.59	\$523.32	\$550.05	\$576.79	\$603.52	\$630.25	\$656.98	
72"	\$562.06	\$588.79	\$615.53	\$642.26	\$668.99	\$695.71	\$722.44	
84"	\$627.53	\$654.26	\$680.98	\$707.72	\$734.45			
96"	\$693.00	\$719.73	\$746.47	\$773.20				
108"	\$758.47	\$785.20	\$811.94					

DIRECT MOUNT ASSEMBLED PRICING

Includes Essentials fabric (see pages 29-30 for all fabric options), 38mm tube, roller mechanisms, brackets, bracket covers, bottom rail with end caps, and child safety device. Designer fabrics +20%. Exclusive fabrics +40%. Side channels are additional. Freight is additional.

LENGTH	WIDTH							
	24"	36"	48"	60"	72"	84"	96"	108"
24"	\$245.23	\$257.63	\$270.04	\$282.47	\$294.88	\$307.29	\$319.71	\$332.12
36"	\$310.69	\$323.11	\$335.52	\$347.93	\$360.35	\$372.76	\$385.19	\$397.60
48"	\$376.16	\$388.57	\$400.99	\$413.41	\$425.83	\$438.23	\$450.64	\$463.07
60"	\$441.64	\$454.04	\$466.45	\$478.88	\$491.29	\$503.71	\$516.11	
72"	\$507.10	\$519.52	\$531.93	\$544.35	\$556.76	\$569.17	\$581.60	
84"	\$572.57	\$584.99	\$597.40	\$609.82	\$622.23			
96"	\$638.05	\$650.45	\$662.87	\$675.29				
108"	\$703.52	\$715.93	\$728.33					















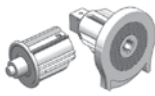
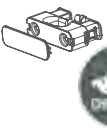



25 White



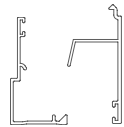
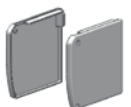

25 White

ROLLER SHADES & ROMANS

APOLLO BASIC | MERCURY DECORATIVE | ATLANTIS HEAVY DUTY | ROLLER SHADE FABRIC OPTIONS | RBS | RBS XL | BCS

CASSETTE	DIRECT	COMPONENT	PRICE	CASSETTE	DIRECT	COMPONENT	PRICE
●	●	 71119-90 1 1/2" / 38mm 19' Tube, aluminum	\$5.84/ft.	●	●	 Endless Chain 25 white plastic or 90 nickel	49020-25, 90, 29" \$2.69 ea. 49021-25, 90, 39" \$3.13 ea. 49022-25, 90, 49" \$3.87 ea. 49023-25, 90, 59" \$4.30 ea. 49024-25, 90, 69" \$4.53 ea. 49025-25, 90, 79" \$4.66 ea. 49026-25, 90, 89" \$4.81 ea. 49027-25, 90, 99" \$5.22 ea.
●	●	 72311-25 Hold Down Strip with adhesive for tube 2,000 ft/roll	\$0.65/ft.	●	●	 79005-00 Clear Ball Stopper	\$1.34 ea.  \$1.12 ea./box 500
●	●	 72309HD-25 Heavy Duty Clutch w/ end plug	\$15.14/set 1 set/box	●	●	 49501-00 Tension Device For child safety	\$10.32 ea.  \$8.59 ea./box 250
●	●	 72306-25 Multi-Purpose Bracket steel, 2 pcs	\$5.30/set 1 set/box	●	●	 810219-25 Bottom Rail	\$6.02/ft.
●	●	 72304-25 Bracket Cover	\$2.58/set 1 set/box	●	●	 810001-25 Weight Insert for bottom rail	\$9.19/ft.
●	●	 72307-90 Wall Bracket steel	\$12.43 ea.	●	●	 810019-25 Adhesive Tape for bottom rail	\$2.87/ft.
●	●	 72308-90 Ceiling Bracket steel	\$4.85 ea.	●	●	 830004-25 End Cap for bottom rail	\$1.40 ea.
●	●	 71312-25 Cassette Headrail, 13'	\$7.06/ft.	●	●	 810000-00 Brush for bottom rail	\$2.50/ft.
●	●	 79001-25 Screw, 2 needed per headrail	\$0.14 ea.	●	●	 2 Piece Outside Mount Side Channel 71619-25 Bottom \$8.29/ft. 71719-25 Top \$7.14/ft.	
●	●	 72314-25 Cassette Bracket Covers	\$10.60/set	●	●	 810119-25 One Piece Inside Mount Side Channel, 19'	\$16.34/ft.
●	●	 79001-25 Screw, 6 needed per set of 2 bracket covers	\$0.14 ea.	●	●	 79002-25 Brush for side channel	\$0.86/ft.
●	●	 71412-25 Cassette Valance, 13' aluminum, white	\$4.49/ft.				

 **BREAK PACK PRICING**  - Prices with this designation indicate a 20% up charge for broken pack quantities.

SEE PAGES 29-30 FOR FABRIC OPTIONS.

ROLLER SHADES APOLLO CASSETTE & DIRECT

ROLLER SHADES & ROMANS

APOLLO BASIC | **MERCURY DECORATIVE** | ATLANTIS HEAVY DUTY | ROLLER SHADE FABRIC OPTIONS | RBS | RBS XL | BCS

ROLLER SHADES MERCURY DOUBLE FASCIA



MERCURY DOUBLE FASCIA

- Ideal for double treatment
- Complete blackout possible with side channels
- Heavy duty with quick and easy installation
- 38mm, 42mm and 50mm tube options and a bi-directional clutch



SPRING CONTROL AVAILABLE



MOTOR CONTROL AVAILABLE

CHAIN DRAW ASSEMBLED PRICING

Includes Essentials fabric (see pages 29-30 for all fabric options), 38mm tube, roller mechanisms, brackets, bracket covers, counterweights or bottom rails with end caps, and child safety device. Designer fabrics +20%. Exclusive fabrics +40%. Side channels are additional. Add 10% for 42mm and 15% for 50mm. Freight is additional.

	WIDTH							
	24"	36"	48"	60"	72"	84"	96"	108"
24"	\$564.02	\$604.64	\$645.27	\$685.90	\$726.52	\$767.16	\$807.79	\$848.41
36"	\$793.80	\$834.44	\$875.06	\$915.69	\$956.33	\$996.94	\$1,037.57	\$1,078.20
48"	\$1,023.60	\$1,064.22	\$1,104.85	\$1,145.48	\$1,186.11	\$1,226.73	\$1,267.37	\$1,307.99
60"	\$1,253.39	\$1,294.01	\$1,334.65	\$1,375.27	\$1,415.90	\$1,456.52	\$1,497.15	
72"	\$1,483.19	\$1,523.80	\$1,564.43	\$1,605.06	\$1,645.69	\$1,686.32		
84"	\$1,712.97	\$1,753.60	\$1,794.22	\$1,834.86	\$1,875.48			
96"	\$1,942.76	\$1,983.40	\$2,024.01	\$2,064.64				
108"	\$2,172.54	\$2,213.18	\$2,253.80					

SPRING CONTROL ASSEMBLED PRICING

Includes Essentials fabric (see pages 29-30 for all fabric options), 38mm tube, roller mechanisms, brackets, bracket covers, and counterweights or bottom rails with end caps. Designer fabrics +20%. Exclusive fabrics +40%. Side channels are additional. Add 10% for 42mm and 15% for 50mm. Freight is additional.

	WIDTH							
	24"	36"	48"	60"	72"	84"	96"	108"
24"	\$676.82	\$725.57	\$774.32	\$823.08	\$871.83	\$920.59	\$969.35	\$1,018.10
36"	\$952.56	\$1,001.33	\$1,050.07	\$1,098.83	\$1,147.59	\$1,196.33	\$1,245.09	\$1,293.84
48"	\$1,228.32	\$1,277.06	\$1,325.83	\$1,374.57	\$1,423.33	\$1,472.08	\$1,520.84	\$1,569.59
60"	\$1,504.07	\$1,552.82	\$1,601.58	\$1,650.33	\$1,699.09	\$1,747.82	\$1,796.58	
72"	\$1,779.82	\$1,828.56	\$1,877.32	\$1,926.08	\$1,974.83	\$2,023.59		
84"	\$2,055.56	\$2,104.32	\$2,153.07	\$2,201.83	\$2,250.58			
96"	\$2,331.31	\$2,380.07	\$2,428.81	\$2,477.57				
108"	\$2,607.05	\$2,655.81	\$2,704.56					

MOTORIZED ASSEMBLED PRICING

Includes Essentials fabric (see pages 29-30 for all fabric options), two 38mm tubes, motor, micro usb cable to charge battery, brackets, bracket covers, counterweight or bottom rail with end caps and remote. Designer fabrics +20%. Exclusive fabrics +40%. Side channels are additional. Add 10% for 42mm and 15% for 50mm. Freight is additional.

	WIDTH							
	24"	36"	48"	60"	72"	84"	96"	108"
24"	\$1,947.19	\$1,987.85	\$2,028.53	\$2,069.19	\$2,109.86	\$2,150.53	\$2,191.18	\$2,231.86
36"	\$2,068.28	\$2,108.95	\$2,149.63	\$2,190.29	\$2,230.96	\$2,271.61	\$2,312.28	\$2,352.94
48"	\$2,189.38	\$2,230.05	\$2,270.71	\$2,311.39	\$2,352.04	\$2,392.71	\$2,433.38	\$2,474.04
60"	\$2,310.48	\$2,351.14	\$2,391.81	\$2,432.49	\$2,473.14	\$2,513.81	\$2,554.47	
72"	\$2,431.58	\$2,472.24	\$2,512.91	\$2,553.56	\$2,594.24	\$2,634.91		
84"	\$2,552.67	\$2,593.34	\$2,634.00	\$2,674.66	\$2,715.33			
96"	\$2,673.77	\$2,714.43	\$2,755.09	\$2,795.76				
108"	\$2,794.87	\$2,835.53	\$2,876.19					



Scan for more information on FOREST Mercury Double Fascia Roller Shades



25 White



70 Bronze



90 Silver













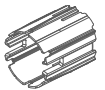
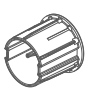
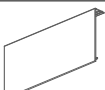
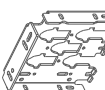



NEW! OPERATE MERCURY SHADES WITH BOND BRIDGE PRO!



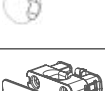







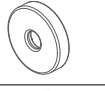



52955-25
Bond Bridge Pro
\$379.00
No discounts on this item

ROLLER SHADES & ROMANS

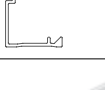
APOLLO BASIC | **MERCURY DECORATIVE** | ATLANTIS HEAVY DUTY | ROLLER SHADE FABRIC OPTIONS | RBS | RBS XL | BCS

FASCIA	COMPONENT	PRICE
●	 Aluminum Tube, 19' 77003-90 38mm \$6.08/ft. 77002-90 42mm \$11.76/ft. 77001-90 50mm \$16.49/ft.	
●	 76013-XX Clutch Mechanism Plastic, 38mm \$25.70 ea.	
●	 76003-25 Tube Adaptor 42mm, 50mm \$1.94 ea.	
●	 Easy Mount End Plug 76005-XX 38mm \$3.04 ea. 76004-XX 42mm, 50mm \$3.85 ea.	
●	 77010-XX Fascia Front, 19' \$22.66/ft.	
●	 76050-XX Fascia Box Bracket \$34.03 ea.	
●	 76051-90 Box Bracket Attachment Adaptor \$6.29/set	
●	 76052-XX Box Bracket End Caps \$12.13/set	
●	 Endless Chain 25 white plastic or 90 nickel 49020-25, 90, 29" \$2.69 ea. 49021-25, 90, 39" \$3.13 ea. 49022-25, 90, 49" \$3.87 ea. 49023-25, 90, 59" \$4.30 ea. 49024-25, 90, 69" \$4.53 ea. 49025-25, 90, 79" \$4.66 ea. 49026-25, 90, 89" \$4.81 ea. 49027-25, 90, 99" \$5.22 ea.	
●	 79005-00 Clear Ball Stopper \$1.34 ea.  \$1.12 ea./box 500	
●	 49501-00 Tension Device \$10.32 ea.  For child safety \$8.59 ea./box 250	
●	 76053-25 Chain Guide Adaptor, Long \$3.18 ea.	
●	 76054-25 Chain Guide Adaptor Medium \$5.89 ea.	

 **BREAK PACK PRICING**  - Prices with this designation indicate a 20% up charge for broken pack quantities.

FASCIA	COMPONENT	PRICE
●	 76002-XX Fill up Ring \$1.70 ea.	
●	 76001-XX Bearing Pin \$2.47 ea.	
●	 810219-25 Bottom Rail \$6.02/ft.	
●	 810001-25 Weight Insert for bottom rail \$9.19/ft.	
●	 810019-25 Adhesive Tape for bottom rail \$2.87/ft.	
●	 830004-25 End Cap for bottom rail \$1.40 ea.	
●	 810000-00 Brush for bottom rail \$2.50/ft.	
●	 2 Piece Outside Mount Side Channel 71619-25 Bottom \$8.29/ft. 71719-25 Top \$7.14/ft.	
●	 810119-25 One Piece Inside Mount Side Channel, 19' \$16.34/ft.	
●	 79002-25 Brush for side channel \$0.86/ft.	
●	 78000-25 Motor & lithium battery \$606.50 ea.	
●	 Drive for Mercury Motor 78001-25 38mm \$20.69 ea. 78020-25 40mm, 50mm \$20.69 ea.	
●	 Crown Adaptor for Mercury Motor 78002-25 38mm \$6.25 ea. 78010-25 40mm, 50mm \$6.04 ea.	
●	 78003-25 Micro USB Cable for motor for Mercury Motor, 9.8 ft. \$26.41 ea.	
●	 78004-59 Remote for Mercury Motor, 5 channel, black \$130.63 ea.	

SEE PAGE 29-30 FOR FABRIC OPTIONS.

ROLLER SHADES & ROMANS

APOLLO BASIC | **MERCURY DECORATIVE** | ATLANTIS HEAVY DUTY | ROLLER SHADE FABRIC OPTIONS | RBS | RBS XL | BCS

ROLLER SHADES MERCURY SEMI OPEN



Scan for more information on FOREST Mercury Semi Open Roller Shades



25 White



59 Black



70 Bronze



90 Silver



NEW! OPERATE MERCURY SHADES WITH BOND BRIDGE PRO!

52955-25
Bond Bridge Pro
\$379.00
No discounts on this item

MERCURY SEMI OPEN MOUNT

- Luxury installation cassette
- As a double, closes perfectly when blind is pulled down
- Almost no light gap on the top due to installation clip
- 38mm, 42mm and 50mm tube options and a bi-directional clutch



SPRING CONTROL AVAILABLE



MOTOR CONTROL AVAILABLE

CHAIN DRAW ASSEMBLED PRICING

Includes Essentials fabric (see pages 29-30 for all fabric options), 38mm tube, roller mechanisms, brackets, bracket covers, and counterweight or bottom rail with end caps. Designer fabrics +20%. Exclusive fabrics +40%. Side channels are additional. Add 10% for 42mm and 15% for 50mm. Freight is additional.

LENGTH	WIDTH							
	24"	36"	48"	60"	72"	84"	96"	108"
24"	\$322.04	\$356.91	\$391.78	\$426.65	\$461.53	\$496.40	\$531.27	\$566.14
36"	\$388.10	\$422.97	\$457.84	\$492.71	\$527.59	\$562.46	\$597.34	\$632.21
48"	\$443.55	\$478.43	\$513.30	\$548.18	\$583.05	\$617.92	\$652.80	\$687.67
60"	\$499.02	\$533.89	\$568.77	\$603.64	\$638.51	\$673.38	\$708.25	
72"	\$554.48	\$589.35	\$624.22	\$659.09	\$693.97	\$728.84		
84"	\$609.92	\$644.80	\$679.67	\$714.54	\$749.41			
96"	\$665.38	\$700.25	\$735.12	\$770.00				
108"	\$720.84	\$755.71	\$790.58					

SPRING CONTROL ASSEMBLED PRICING

Includes Essentials fabric (see pages 29-30 for all fabric options), 38mm tube, roller mechanisms, brackets, bracket covers, and counterweight or bottom rail with end caps. Designer fabrics +20%. Exclusive fabrics +40%. Side channels are additional. Add 10% for 42mm and 15% for 50mm. Freight is additional.

LENGTH	WIDTH							
	24"	36"	48"	60"	72"	84"	96"	108"
24"	\$386.45	\$428.29	\$470.14	\$511.99	\$553.83	\$595.68	\$637.52	\$679.37
36"	\$465.72	\$507.56	\$549.41	\$591.26	\$633.10	\$674.95	\$716.81	\$758.65
48"	\$532.27	\$574.11	\$615.96	\$657.82	\$699.66	\$741.51	\$783.36	\$825.20
60"	\$598.83	\$640.67	\$682.52	\$724.36	\$766.21	\$808.06	\$849.90	
72"	\$665.37	\$707.22	\$749.07	\$790.91	\$832.76	\$874.60		
84"	\$731.91	\$773.75	\$815.60	\$857.45	\$899.29			
96"	\$798.46	\$840.30	\$882.15	\$923.99				
108"	\$865.00	\$906.85	\$948.70					











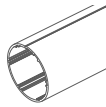

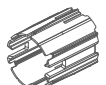
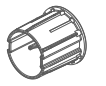
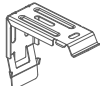
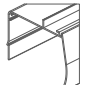
MOTORIZED ASSEMBLED PRICING











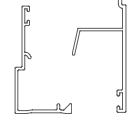

Includes Essentials fabric (see pages 29-30 for all fabric options), 38mm tube, motor, micro usb cable to charge battery, brackets, bracket covers, bottom rail with end caps and remote. Designer fabrics +20%. Freight is additional.

LENGTH	WIDTH							
	24"	36"	48"	60"	72"	84"	96"	108"
24"	\$1,127.63	\$1,168.05	\$1,208.46	\$1,248.88	\$1,289.30	\$1,329.72	\$1,370.13	\$1,410.55
36"	\$1,193.08	\$1,233.50	\$1,273.92	\$1,314.33	\$1,354.76	\$1,395.18	\$1,435.60	\$1,476.01
48"	\$1,258.54	\$1,298.96	\$1,339.38	\$1,379.80	\$1,420.21	\$1,460.63	\$1,501.05	\$1,541.47
60"	\$1,323.99	\$1,364.42	\$1,404.84	\$1,445.26	\$1,485.67	\$1,526.09	\$1,566.51	
72"	\$1,389.46	\$1,429.87	\$1,470.29	\$1,510.71	\$1,551.13	\$1,591.54		
84"	\$1,454.92	\$1,495.34	\$1,535.75	\$1,576.17	\$1,616.59			
96"	\$1,520.37	\$1,560.79	\$1,601.22	\$1,641.63				
108"	\$1,585.83	\$1,626.25	\$1,666.67					



ROLLER SHADES & ROMANS

APOLLO BASIC | **MERCURY DECORATIVE** | ATLANTIS HEAVY DUTY | ROLLER SHADE FABRIC OPTIONS | RBS | RBS XL | BCS

SEMI OPEN	COMPONENT	PRICE
●	 Aluminum Tube, 19' 77003-90 38mm 77002-90 42mm 77001-90 50mm	\$6.08/ft. \$11.76/ft. \$16.49/ft.
●	 76013-XX Clutch Mechanism Plastic, 38mm	\$25.70 ea.
●	 76003-25 Tube Adaptor 42mm, 50mm	\$1.94 ea.
●	 Easy Mount End Plug 76005-XX 38mm 76004-XX 42mm, 50mm	\$3.04 ea. \$3.85 ea.
●	 76019-XX Semi Open Bracket for Cassette	\$9.28 ea.
●	 77008-XX Semi Open Cassette, 19'	\$21.58/ft.
●	 77007-XX Semi Open Cassette End Cap Set	\$10.74/set
●	 76018-90 Cassette Set	\$13.03/set
●	 Endless Chain 25 white plastic or 90 nickel 49020-25, 90, 29" 49021-25, 90, 39" 49022-25, 90, 49" 49023-25, 90, 59" 49024-25, 90, 69" 49025-25, 90, 79" 49026-25, 90, 89" 49027-25, 90, 99"	\$2.69 ea. \$3.13 ea. \$3.87 ea. \$4.30 ea. \$4.53 ea. \$4.66 ea. \$4.81 ea. \$5.22 ea.
●	 79005-00 Clear Ball Stopper	\$1.34 ea.  \$1.12 ea./box 500
●	 49501-00 Tension Device For child safety	\$10.32 ea.  \$8.59 ea./box 250
●	 76002-XX Fill up Ring	\$1.70 ea.
●	 76001-XX Bearing Pin	\$2.47 ea.

SEMI OPEN	COMPONENT	PRICE
●	 810219-25 Bottom Rail	\$6.02/ft.
●	 810001-25 Weight Insert for bottom rail	\$9.19/ft.
●	 810019-25 Adhesive Tape for bottom rail	\$2.87/ft.
●	 830004-25 End Cap for bottom rail	\$1.40 ea.
●	 810000-00 Brush for bottom rail	\$2.50/ft.
●	 2 Piece Outside Mount Side Channel 71619-25 Bottom 71719-25 Top	\$8.29/ft. \$7.14/ft.
●	 810119-25 One Piece Inside Mount Side Channel, 19'	\$16.34/ft.
●	 79002-25 Brush for side channel	\$0.86/ft.
●	 78000-25 Motor & lithium battery	\$606.50 ea.
●	 Drive for Mercury Motor 78001-25 38mm 78020-25 40mm, 50mm	\$20.69 ea. \$20.69 ea.
●	 Crown Adaptor for Mercury Motor 78002-25 38mm 78010-25 40mm, 50mm	\$6.25 ea. \$6.04 ea.
●	 78003-25 Micro USB Cable for Mercury Motor, 9.8 ft.	\$26.41 ea.
●	 78004-59 Remote for Mercury Motor, 5 channel, black	\$130.63 ea.

SEE PAGE 29-30 FOR FABRIC OPTIONS.

 **BREAK PACK PRICING**  - Prices with this designation indicate a 20% up charge for broken pack quantities.

ROLLER SHADES & ROMANS

APOLLO BASIC | **MERCURY DECORATIVE** | ATLANTIS HEAVY DUTY | ROLLER SHADE FABRIC OPTIONS | RBS | RBS XL | BCS

ROLLER SHADES MERCURY DIRECT MOUNT



Scan for more information on FOREST Mercury Direct Mount Roller Shades



MERCURY DIRECT MOUNT

- End caps in designer colors
- Contemporary, clean look
- Easy Installation
- 38mm, 42mm and 50mm tube options and a bi-directional clutch



SPRING CONTROL AVAILABLE



MOTOR CONTROL AVAILABLE

CHAIN DRAW ASSEMBLED PRICING

Includes Essentials fabric (see pages 29-30 for all fabric options), 38mm tube, roller mechanisms, brackets, bracket covers, and counterweight or bottom rail with end caps. Designer fabrics +20%. Exclusive fabrics +40%. Side channels are additional. Add 10% for 42mm and 15% for 50mm. Freight is additional.

		WIDTH							
		24"	36"	48"	60"	72"	84"	96"	108"
LENGTH	24"	\$317.11	\$325.66	\$334.22	\$342.75	\$351.31	\$359.86	\$368.40	\$376.95
	36"	\$372.55	\$381.10	\$389.66	\$398.20	\$406.76	\$415.29	\$423.85	\$432.38
	48"	\$428.00	\$436.55	\$445.10	\$453.64	\$462.19	\$470.74	\$479.28	\$487.83
	60"	\$483.45	\$491.99	\$500.54	\$509.08	\$517.64	\$526.17	\$534.73	
	72"	\$538.88	\$547.43	\$555.98	\$564.52	\$573.07	\$581.62		
	84"	\$594.33	\$602.87	\$611.42	\$619.96	\$628.52			
	96"	\$649.76	\$658.31	\$666.87	\$675.40				
	108"	\$705.21	\$713.76	\$722.30					

SPRING CONTROL ASSEMBLED PRICING

Includes Essentials fabric (see pages 29-30 for all fabric options), 38mm tube, roller mechanisms, brackets, bracket covers, and counterweight or bottom rail with end caps. Designer fabrics +20%. Exclusive fabrics +40%. Side channels are additional. Add 10% for 42mm and 15% for 50mm. Freight is additional.

		WIDTH							
		24"	36"	48"	60"	72"	84"	96"	108"
LENGTH	24"	\$380.53	\$390.79	\$401.06	\$411.30	\$421.57	\$431.83	\$442.08	\$452.34
	36"	\$447.06	\$457.33	\$467.59	\$477.84	\$488.11	\$498.35	\$508.62	\$518.86
	48"	\$513.60	\$523.86	\$534.12	\$544.37	\$554.63	\$564.88	\$575.14	\$585.40
	60"	\$580.14	\$590.38	\$600.65	\$610.89	\$621.16	\$631.41	\$641.67	
	72"	\$646.66	\$656.92	\$667.17	\$677.43	\$687.68	\$697.94		
	84"	\$713.20	\$723.44	\$733.71	\$743.95	\$754.22			
	96"	\$779.72	\$789.97	\$800.24	\$810.49				
	108"	\$846.25	\$856.51	\$866.76					

MOTORIZED ASSEMBLED PRICING

Includes Essentials fabric (see pages 29-30 for all fabric options), 38mm tubs, motor, micro usb cable to charge battery, brackets, bracket covers, counterweight or bottom rail with end caps and remote. Designer fabrics +20%. Exclusive fabrics +40%. Side channels are additional. Add 10% for 42mm and 15% for 50mm. Freight is additional.

		WIDTH							
		24"	36"	48"	60"	72"	84"	96"	108"
LENGTH	24"	\$1,075.40	\$1,098.86	\$1,122.32	\$1,145.77	\$1,169.22	\$1,192.68	\$1,216.13	\$1,239.59
	36"	\$1,140.90	\$1,164.35	\$1,187.80	\$1,211.27	\$1,234.72	\$1,258.18	\$1,281.62	\$1,305.08
	48"	\$1,206.40	\$1,229.85	\$1,253.31	\$1,276.77	\$1,300.22	\$1,323.67	\$1,347.13	\$1,370.58
	60"	\$1,271.90	\$1,295.34	\$1,318.80	\$1,342.25	\$1,365.72	\$1,389.17	\$1,412.62	
	72"	\$1,337.39	\$1,360.84	\$1,384.30	\$1,407.75	\$1,431.20	\$1,454.66		
	84"	\$1,402.89	\$1,426.35	\$1,449.79	\$1,473.25	\$1,496.70			
	96"	\$1,468.38	\$1,491.84	\$1,515.29	\$1,538.75				
	108"	\$1,533.89	\$1,557.34	\$1,580.79					













NEW! OPERATE MERCURY SHADES WITH BOND BRIDGE PRO!

52955-25
Bond Bridge Pro
\$379.00
No discounts on this item

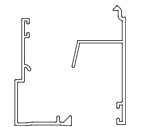
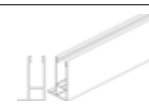

ROLLER SHADES & ROMANS

APOLLO BASIC | **MERCURY DECORATIVE** | ATLANTIS HEAVY DUTY | ROLLER SHADE FABRIC OPTIONS | RBS | RBS XL | BCS

DIRECT	COMPONENT	PRICE
•	 Aluminum Tube, 19' 77003-90 38mm \$6.08/ft. 77002-90 42mm \$11.76/ft. 77001-90 50mm \$16.49/ft.	
•	 76013-25, 59, 70, 90, 99 \$25.70 ea. Clutch Mechanism Plastic, 38mm	
•	 76003-25 \$1.94 ea. Tube Adaptor 42mm, 50mm	
•	 Easy Mount End Plug 76005-25, 59, 70, 90, 99 \$3.04 ea. 38mm \$3.85 ea. 76004-25, 59, 70, 90, 99 42mm, 50mm	
•	 76010-25, 59, 70, 90, 99 \$4.76 ea. Metal Bracket	
•	 76006-25, 59, 70, 90, 99 \$3.22 ea. End Cap, Plastic	
•	 76007-16, 22, 25 \$27.54 ea. End Cap Metal	
•	 Endless Chain 25 white plastic or 90 nickel 49020-25, 90, 29" \$2.69 ea. 49021-25, 90, 39" \$3.13 ea. 49022-25, 90, 49" \$3.87 ea. 49023-25, 90, 59" \$4.30 ea. 49024-25, 90, 69" \$4.53 ea. 49025-25, 90, 79" \$4.66 ea. 49026-25, 90, 89" \$4.81 ea. 49027-25, 90, 99" \$5.22 ea.	
•	 79005-00 \$1.34 ea.  Clear Ball Stopper \$1.12 ea./box 500	
•	 49501-00 \$10.32 ea.  Tension Device For child safety \$8.59 ea./box 250	
•	 76002-XX \$1.70 ea. Fill up Ring	
•	 76001-XX \$2.47 ea. Bearing Pin	

DIRECT	COMPONENT	PRICE
•	 810219-25 \$6.02/ft. Bottom Rail	
•	 810001-25 \$9.19/ft. Weight Insert for bottom rail	
•	 810019-25 \$2.87/ft. Adhesive Tape for bottom rail	
•	 830004-25 \$1.40 ea. End Cap for bottom rail	
•	 810000-00 \$2.50/ft. Brush for bottom rail	
•	 2 Piece Outside Mount Side Channel 71619-25 Bottom \$8.29/ft. 71719-25 Top \$7.14/ft.	
•	 810119-25 \$16.34/ft. One Piece Inside Mount Side Channel, 19'	
•	 79002-25 \$0.86/ft. Brush for side channel	
•	 78000-25 \$606.50 ea. Motor & lithium battery	
•	 Drive for Mercury Motor 78001-25 38mm \$20.69 ea. 78020-25 40mm, 50mm \$20.69 ea.	
•	 Crown Adaptor for Mercury Motor 78002-25 38mm \$6.25 ea. 78010-25 40mm, 50mm \$6.04 ea.	
•	 78003-25 \$26.41 ea. Micro USB Cable for Mercury Motor, 9.8 ft.	
•	 78004-59 \$130.63 ea. Remote for Mercury Motor, 5 channel, black	

SEE PAGE 29-30 FOR FABRIC OPTIONS.

 **BREAK PACK PRICING**  - Prices with this designation indicate a 20% up charge for broken pack quantities.

ROLLER SHADES & ROMANS

APOLLO BASIC | MERCURY DECORATIVE | **ATLANTIS HEAVY DUTY** | ROLLER SHADE FABRIC OPTIONS | RBS | RBS XL | BCS



Scan for more information on FOREST Atlantis HD Motorized Roller Shades

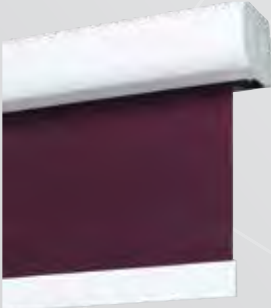

25
White



ATLANTIS HEAVY DUTY MOTORIZED ROLLER SHADES

- Atlantis is a heavy duty system with a maximum weight of 45 lbs. Includes a 10-year warranty.
- Easy Installation with universal adjustable brackets
- 50mm and 60mm tube options and a bi-directional clutch

CASSETTE MOUNT ASSEMBLED PRICING

Includes Essentials fabric (see pages 29-30 for all fabric options), tube, roller mechanism, brackets, bracket covers, cassette cover, motor, Diamond remote or wall switch, & bottom rail w/ end caps. Designer fabrics +20%. Exclusive fabrics +40%. Side channels are additional. Freight is additional.

LENGTH	WIDTH									
	50 mm diameter tube included. +20% for 60 mm				60 mm diameter tube included and recommended at these widths					
	24"	36"	48"	60"	72"	84"	96"	108"	120"	
24"	\$1,266.18	\$1,307.57	\$1,348.95	\$1,390.34	\$1,431.71	\$1,481.07	\$1,522.96	\$1,564.84	\$1,606.73	
36"	\$1,319.59	\$1,360.97	\$1,402.35	\$1,443.74	\$1,485.13	\$1,534.47	\$1,576.36	\$1,618.25	\$1,660.14	
48"	\$1,372.99	\$1,414.37	\$1,455.76	\$1,497.14	\$1,538.53	\$1,587.88	\$1,629.76	\$1,671.65	\$1,713.54	
60"	\$1,426.39	\$1,467.78	\$1,509.16	\$1,550.54	\$1,591.92	\$1,641.29	\$1,683.18	\$1,725.05	\$1,766.94	
72"	\$1,479.80	\$1,521.18	\$1,562.57	\$1,603.95	\$1,645.34	\$1,694.68	\$1,736.57	\$1,778.46	\$1,820.35	
84"	\$1,533.20	\$1,574.58	\$1,615.97	\$1,657.35	\$1,698.74	\$1,748.09	\$1,789.97	\$1,831.86	\$1,873.75	
96"	\$1,586.61	\$1,627.99	\$1,669.37	\$1,710.76	\$1,752.13	\$1,801.50	\$1,843.39	\$1,885.27	\$1,927.14	
108"	\$1,640.00	\$1,681.39	\$1,722.78	\$1,764.16	\$1,805.55	\$1,854.89	\$1,896.78	\$1,938.67	\$1,980.56	
120"	\$1,693.41	\$1,734.79	\$1,776.18	\$1,817.56	\$1,858.95	\$1,908.29	\$1,950.18	\$1,992.07	\$2,033.96	
132"	\$1,746.82	\$1,788.21	\$1,829.58	\$1,870.97	\$1,912.34	\$1,961.71	\$2,003.59	\$2,045.47	\$2,087.36	
144"	\$1,800.22	\$1,841.60	\$1,882.99	\$1,924.37	\$1,965.76	\$2,015.10	\$2,057.00	\$2,098.89	\$2,140.77	





DIRECT MOUNT ASSEMBLED PRICING











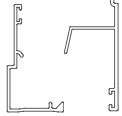

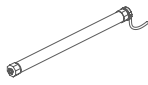
Includes Essentials fabric (see pages 29-30 for all fabric options), tube, roller mechanism, brackets, bracket covers, motor, Diamond remote or wall switch, & bottom rail with end caps. Designer fabrics +20%. Exclusive fabrics +40%. Side channels are additional. Freight is additional.

LENGTH	WIDTH									
	50 mm diameter tube included. +20% for 60 mm				60 mm diameter tube included and recommended at these widths					
	24"	36"	48"	60"	72"	84"	96"	108"	120"	
24"	\$1,239.36	\$1,266.74	\$1,294.12	\$1,321.50	\$1,348.86	\$1,384.20	\$1,412.10	\$1,439.99	\$1,467.87	
36"	\$1,292.77	\$1,320.14	\$1,347.52	\$1,374.90	\$1,402.27	\$1,437.60	\$1,465.50	\$1,493.39	\$1,521.28	
48"	\$1,346.18	\$1,373.55	\$1,400.91	\$1,428.29	\$1,455.67	\$1,491.02	\$1,518.90	\$1,546.79	\$1,574.68	
60"	\$1,399.57	\$1,426.95	\$1,454.33	\$1,481.70	\$1,509.07	\$1,544.42	\$1,572.31	\$1,600.20	\$1,628.08	
72"	\$1,452.98	\$1,480.35	\$1,507.73	\$1,535.11	\$1,562.49	\$1,597.81	\$1,625.72	\$1,653.60	\$1,681.49	
84"	\$1,506.39	\$1,533.76	\$1,561.12	\$1,588.50	\$1,615.88	\$1,651.23	\$1,679.11	\$1,707.01	\$1,734.89	
96"	\$1,559.78	\$1,587.16	\$1,614.54	\$1,641.91	\$1,669.28	\$1,704.63	\$1,732.52	\$1,760.40	\$1,788.30	
108"	\$1,613.19	\$1,640.56	\$1,667.94	\$1,695.32	\$1,722.70	\$1,758.03	\$1,785.93	\$1,813.81	\$1,841.70	
120"	\$1,666.60	\$1,693.97	\$1,721.34	\$1,748.72	\$1,776.10	\$1,811.44	\$1,839.33	\$1,867.22	\$1,895.10	
132"	\$1,719.99	\$1,747.37	\$1,774.76	\$1,802.12	\$1,829.49	\$1,864.84	\$1,892.73	\$1,920.61	\$1,948.51	
144"	\$1,773.41	\$1,800.77	\$1,828.15	\$1,855.53	\$1,882.91	\$1,918.24	\$1,946.14	\$1,974.02	\$2,001.91	

ROLLER SHADES & ROMANS

APOLLO BASIC | MERCURY DECORATIVE | **ATLANTIS HEAVY DUTY** | ROLLER SHADE FABRIC OPTIONS | RBS | RBS XL | BCS

ATLANTIS	COMPONENT	PRICE
●	 Aluminum Tube, 19' 815019-00 50mm for shades up to 72" 816019-00 60mm for shades up to 144"	\$16.34/ft. \$20.23/ft.
●	 82CL01-25 Left 82CR01-25 Right Standard Ceiling/Wall Idler Brackets	\$59.85 ea.
●	 820003-25 Middle Adjustable Ceiling Idler Bracket	\$73.25 ea.
●	 82CL00-25 Left 82CR00-25 Right Standard Ceiling/Wall Motor Bracket	\$36.39 ea.
●	 820004-25 Middle Adjustable Ceiling Connecting Bracket	\$61.54 ea.
●	 820005-25 Middle Adjustable Ceiling Cassette Connecting Bracket	\$67.02 ea.
●	 810319-25 Cassette Cover, 19'	\$16.71/ft.
●	 830001-25 Bracket End Cap	\$4.38 ea.
●	 830002-25 Middle Bracket Cover	\$4.18 ea.
●	 810219-25 Bottom Rail	\$6.02/ft.
●	 810001-25 Weight Insert for bottom rail	\$9.19/ft.
●	 810019-25 Adhesive Tape for bottom rail and tube attachment	\$2.87/ft.
●	 830004-25 End Cap for bottom rail	\$1.40 ea.
●	 810000-00 Brush for bottom rail	\$2.50/ft.
●	 810119-25 One Piece Inside Mount Side Channel, 19'	\$16.34/ft.

ATLANTIS	COMPONENT	PRICE
●	 2 Piece Outside Mount Side Channel 71619-25 Bottom 71719-25 Top	\$8.29/ft. \$7.14/ft.
●	 79002-25 Brush for side channel	\$0.86/ft.
●	 62901-25 Forest Tubular Motor built-in RF receiver, 35mm, 110v, 6 Nm	\$738.09 ea.
●	 835000-00 50mm Motor Adaptor	\$34.81 ea.
●	 835001-00 50mm Idler	\$3.44 ea.
●	 835002-00 50mm Connector Idler	\$3.44 ea.
●	 835003-00 50mm Adjustable Idler	\$42.89 ea.
●	 836000-00 60mm Motor Adaptor	\$40.56 ea.
●	 836001-00 60mm Idler	\$5.57 ea.
●	 52931-25D white 59D black +10% Diamond Remote RF, 15 channel w/ holder Range 98'	\$434.19 ea. 1/box
●	 52933-25 white 59 black +10% Diamond Wall Switch 2 channel	\$213.73 ea. 1/box
●	 52947-25 Wireless Connector One-way transmitter to control drapery by third party app or home automation.	\$268.91 ea. 1/box
●	 52955-25 Bond Bridge Pro	\$379.00 ea. 1/box No discounts on this item

SEE PAGE 29-30 FOR FABRIC OPTIONS.

ROLLER SHADES ATLANTIS HEAVY DUTY MOTORIZED

ROLLER SHADES & ROMANS

APOLLO BASIC | MERCURY DECORATIVE | ATLANTIS HEAVY DUTY | **ROLLER SHADE FABRIC OPTIONS** | RBS | RBS XL | BCS

FABRIC OPTIONS FOR ROLLER SHADES

IN STOCK FABRICS are divided across three collections – Essentials, Designer and Exclusive to meet your specific needs for value and style. Contact customer service for a swatch card, customerservice@forestdh.com.

All fabrics are suitable for any of our roller shade systems.

Fabric images are a close representation, but for best results please email customerservice@forestdh.com to order a swatch card.



ESSENTIALS COLLECTION

The Forest Essentials Fabric Collection offers quality at a value. Choose a 3% screen, a sheer or a blackout fabric to coordinate with your room design.

SCREENS



Bone White
74002-99

118" / 3% /



Vanilla Creme
74004-97

118" / 3% /

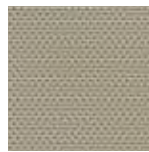

Copenhagen
74020-81

98" / 3% /

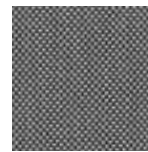

Charcoal
74003-55

118" / 3% /

SHEERS

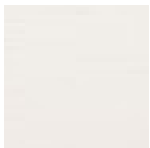

White Linen
74007-25

110" / 20% /



Broad Lines
74008-25

94" / 20% /



Fine Lines
74009-25

94" / 20% /

BLACKOUT

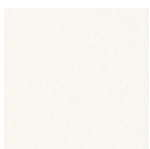

Frost
74005-01

118" / 0% /

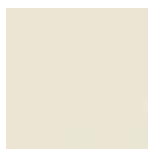

Ecrú
74001-98

108" / 0% /



Pewter
74006-08

118" / 0% /

This symbol denotes a fire retardant fabric.

ROLLER SHADES & ROMANS

APOLLO BASIC | MERCURY DECORATIVE | ATLANTIS HEAVY DUTY | **ROLLER SHADE FABRIC OPTIONS** | RBS | RBS XL | BCS



DESIGNER COLLECTION

The Forest Designer Fabric Collection offers the latest styles and colors of roller shade fabric. There is a premium up-charge for fabrics in the Designer Collection.

SCREENS



Richland
75001-01
118" / 6% /



Pearland
75001-02
118" / 6% /



Hamburg
75001-03
118" / 3% /

SHEERS



Singapore
75001-04
94" / 11% /



Manila
75001-05
94" / <3%

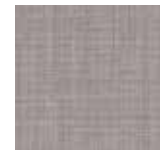

Mumbai
75001-06
118" / 3% /

WOVENS



Sao Paulo
75001-07
118" / 28% /



Salvador
75001-08
118" / 3% /



Asheville
75001-09
118" / 25%

NATURALS

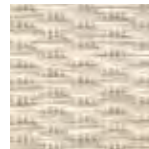

Macau
75001-10
70"

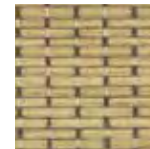

Tokyo
75001-11
78"

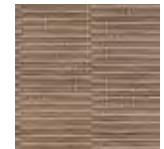

Taipei
75001-12
94"

BLACKOUT



Woodbury
75001-13
118" / 0% /



Seaside
75001-14
110" / 0% /



Capetown
75001-15
110" / 0%



EXCLUSIVES COLLECTION

The Forest Exclusive Fabric Collection offers distinctive fabrics. There is a premium up-charge for fabrics in the Exclusives Collection.

SCREEN



Moscow
76001-10
118" / 7%

WOVEN



Montauk
76001-20
110" / 15%

BLACKOUT



Whitehall
76001-30
94.5" / 0% /

This symbol denotes a fire retardant fabric.

ROLLER SHADES & ROMANS

APOLLO BASIC | MERCURY DECORATIVE | ATLANTIS HEAVY DUTY | ROLLER SHADE FABRIC OPTIONS | **RBS** | RBS XL | BCS

ROMANS RBS CHAIN DRAW



Scan for more information on the FOREST RBS Roman Blind System

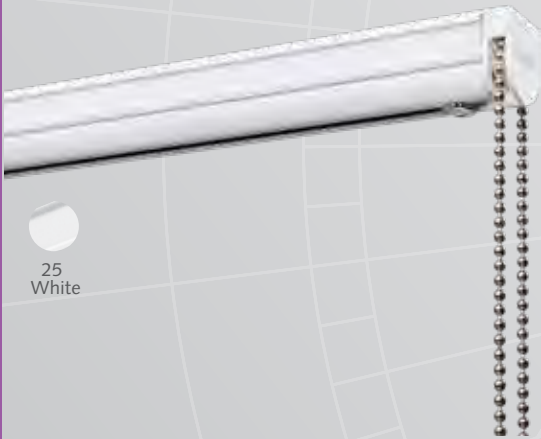

25
White

RBS ROMAN BLIND SYSTEM

- The most durable and functional roman blind system on the market. RBS includes integrated Velcro tape so the fabric can be easily attached and removed.
- Aluminum, white, powder coated extrusion. Best suited for light to medium weight fabrics in contract or residential applications.
- Maximum weights:
1:4 gear up to 18 lbs.
1:2 gear up to 14 lbs.
1:1 gear up to 10 lbs.
- Includes child safety device and warning label. A motorized option is also available on pages 33-34.

ASSEMBLED PRICING

Includes headrail, cord roll supports, wall or ceiling brackets, counterweight (if requested), Velcro profile, chain, child safety tension device & warning label. When ordering, please specify chain drop length, wall or ceiling mount, control side, and number of cord roll supports needed. Freight is additional.

RBS ROMAN BLIND SYSTEM	first 4 feet	ea. add'l inch
White	\$159.39	\$3.36



MOTOR CONTROL
P. 33-34

ROLLER SHADES & ROMANS

APOLLO BASIC | MERCURY DECORATIVE | ATLANTIS HEAVY DUTY | ROLLER SHADE FABRIC OPTIONS | **RBS** | RBS XL | BCS

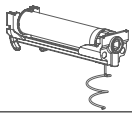
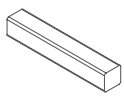
RBS	COMPONENT	PRICE	RBS	COMPONENT	PRICE
●	 41019-25 RBS Headrail 19' x 10 rails/bundle bundle = 190'	\$9.19/ft.	●	 49008-25 Shade Leveler	\$0.67 ea. \$0.57 ea. /box of 1000
●	 49010-25 RBS Cord Roll Support w/ quick lock, 12' drop	\$8.80 ea. \$7.99 ea. /box of 100	●	 39007-25 Velcro Tape 27 yds. per roll	\$34.21/roll
●	 Control Unit w/ End Cap & Retaining Ring heavy duty, self-braking 42311-25 1:4 gear to 18 lbs. 42312-25 1:2 gear to 14 lbs. 42310-25 1:1 gear to 10 lbs.	\$20.47 ea. \$17.06 ea. /box of 100	●	 49006-25 Fiberglass Spines, 19' 3/16" diameter	\$0.63/ft. \$0.55/ft. /bundle of 250
●	 41119-90 19' Rod aluminum 3/16" x 3/16"	\$3.25/ft. \$2.71/ft. /bundle of 5	●	 49014-25 Plastic Snap Ring	\$0.15 ea. \$0.12 ea. /box of 5000
●	 49005-25 Counterweight, 19' aluminum 1" x 1/8"	\$3.01/ft. \$2.39/ft. /bundle of 20	●	 49013-25 Plastic Ring Cord Guide	\$0.15 ea. \$0.12 ea. /box of 5000
●	 31116-25 Velcro Profile w/ Hook Tape, 13.1'	\$5.72/ft. \$4.75/ft. /bundle of 20	●	 Endless Chain 25 white plastic or 90 nickel 49020-25, 90, 29" 49021-25, 90, 39" 49022-25, 90, 49" 49023-25, 90, 59" 49024-25, 90, 69" 49025-25, 90, 79" 49026-25, 90, 89" 49027-25, 90, 99"	\$2.69 ea. \$3.13 ea. \$3.87 ea. \$4.30 ea. \$4.53 ea. \$4.66 ea. \$4.81 ea. \$5.22 ea.
●	 43202-25 Swivel Wall Bracket	\$2.76 ea. \$2.30 ea. /box of 100	●	 76047-90 Metal Ball Chain Stopper	\$0.67 ea.
●	 43003-25 Swivel Ceiling Bracket	\$3.11 ea. \$2.59 ea. /box of 100	●	 79005-00 Clear Ball Chain Stopper	\$1.34 ea. \$1.12 ea. /box of 500
●	 43033-25 Klick Wall Bracket	\$3.11 ea. \$2.59 ea. /box of 100	●	 49501-00 Tension Device For child safety	\$10.32 ea. \$8.59 ea./box 250
●	 43034-25 Hidden Klick Multi Bracket	\$3.11 ea. \$2.59 ea. /box of 100			
●	 43004-25 Klick Ceiling Bracket	\$3.11 ea. \$2.59 ea. /box of 100			

BREAK PACK PRICING - Prices with this designation indicate a 20% up charge for broken pack quantities.

ROLLER SHADES & ROMANS

APOLLO BASIC | MERCURY DECORATIVE | ATLANTIS HEAVY DUTY | ROLLER SHADE FABRIC OPTIONS | **RBS** | RBS XL | BCS



Scan for more information on the FOREST RBS Motorized System



CHAIN CONTROL
P. 31-32

RBS MOTORIZED ROMAN BLIND SYSTEM



- The most durable and functional roman blind system on the market. RBS includes integrated Velcro tape so the fabric can be easily attached and removed.
- Aluminum, white, powder coated extrusion. Best suited for light weight fabrics in contract or residential applications.
- Maximum weight is 10 lbs with a maximum width of 84".
- The Forest tubular motor includes a 10 year warranty. The lithium iOn battery includes a 1 year warranty.



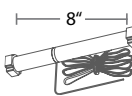
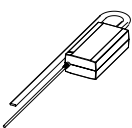

ASSEMBLED PRICING

Includes headrail, cord roll supports, brackets, counterweight (if requested), Velcro profile, motor and remote or wall switch. When ordering, please specify motor side, wall or ceiling mount, and number of cord roll supports needed. Freight is additional.

RBS Motorized Roman Blind System	first 3 feet	ea. add'l inch
Standard Motor	\$945.03	\$3.37
Lithium iOn Battery Motor	\$960.33	\$3.37

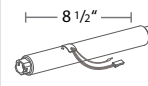

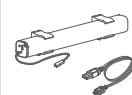

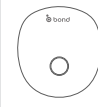

ROMANS RBS MOTORIZED

RBS MOT	COMPONENT	PRICE
● 	62903-25 RBS Tubular Motor, 24 V Double Shaft Lifts up to 10 lbs.	\$390.23 ea. 1/box
● 	52928-25 7' 6" power cord 52934-25 16' power cord Includes 24 v Power Supply	\$170.18 ea. 1/box
● 	52931-25D white 59D black +10% Diamond Sense Remote RF, 15 channel w/ holder, Range 98'	\$434.19 ea. 1/box
● 	52933-25 white 59 black +10% Diamond Sense Wall Switch 2 channel	\$213.73 ea. 1/box

RBS MOT	COMPONENT	PRICE
● 	62910-25 RBS Tubular Lithium Motor, 1-year warranty 24 V, includes plug	\$514.34 ea. 1/box
● 	62911-25 Remote for Lithium Motor 15 channel w/ holder	\$85.77 ea. 1/box
● 	62912-25 Lithium Battery & Adaptor	\$308.11 ea. 1/box
● 	52947-25 Wireless Connector One-way transmitter to control drapery by third party app or by home automation. Use with Forest Shuttle & tubular motors.	\$268.91 ea. 1/box
● 	52955-25 Bond Bridge Pro	\$379.00 ea. 1/box No discounts on this item

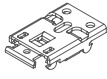
ROLLER SHADES & ROMANS

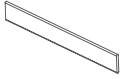
APOLLO BASIC | MERCURY DECORATIVE | ATLANTIS HEAVY DUTY | ROLLER SHADE FABRIC OPTIONS | **RBS** | RBS XL | BCS

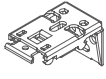
RBS MOT	COMPONENT	PRICE	RBS MOT	COMPONENT	PRICE
●	 41019-25 RBS Headrail white 19' x 10 rails/bundle bundle = 190'	\$9.19/ft.	●	 43034-25 Hidden Klick Multi Bracket	\$3.11 ea.  \$2.59 ea. /box of 100
●	 49010-25 RBS Cord Roll Support w/ quick lock, 12' drop	\$8.80 ea.  \$7.99 ea. /box of 100	●	 43004-25 Klick Ceiling Bracket	\$3.11 ea.  \$2.59 ea. /box of 100
●	 62913-25 RBS End Caps left & right	\$2.04/set of 2	●	 49090-25 Valance Bracket attaches to Velcro profile	\$3.58 ea.  \$2.99 ea. /box of 50
●	 41119-90 19' Rod aluminum 3/16" x 3/16"	\$3.25/ft.  \$2.71/ft. /bundle of 5	●	 49091-25 Valance Corners	\$5.21 ea.  \$4.34 ea. /box of 250
●	 49005-25 Counterweight, 19' aluminum 1" x 1/8"	\$3.01/ft.  \$2.39/ft. /bundle of 20	●	 49008-00 Shade Leveler	\$0.67 ea.  \$0.57 ea. /box of 1000
●	 31116-25 Velcro Profile w/ Hook Tape, 13.1'	\$5.72/ft.  \$4.75/ft. /bundle of 20	●	 39007-25 Velcro Tape 27 yds. per roll	\$34.21/roll
●	 43202-25 Swivel Wall Bracket	\$2.76 ea.  \$2.30 ea. /box of 100	●	 49006-25 Fiberglass Spines, 19' 3/16" diameter	\$0.63/ft.  \$0.55/ft. /bundle of 250
●	 43003-25 Swivel Ceiling Bracket	\$3.11 ea.  \$2.59 ea. /box of 100	●	 49014-25 Plastic Snap Ring	\$0.15 ea.  \$0.12 ea. /box of 5000
●	 43033-25 Klick Wall Bracket	\$3.11 ea.  \$2.59 ea. /box of 100	●	 49013-25 Plastic Ring Cord Guide	\$0.15 ea.  \$0.12 ea. /box of 5000

 **BREAK PACK PRICING**  - Prices with this designation indicate a 20% up charge for broken pack quantities.

ROMANS RBS MOTORIZED

ROLLER SHADES & ROMANS

APOLLO BASIC | MERCURY DECORATIVE | ATLANTIS HEAVY DUTY | ROLLER SHADE FABRIC OPTIONS | RBS | **RBS XL** | BCS

ROMANS RBS XL



Scan for more information on the FOREST RBS XL Roman Blind System

RBS XL ROMAN BLIND SYSTEM

- Aluminum, white, powder coated extrusion. Best suited for light to medium weight fabrics in contract or residential applications.
- Includes integrated Velcro tape so the fabric can be easily attached and removed.
- Maximum weight is a 1:4 gear which will pull up to 24 lbs.
- Includes child safety device and warning label.

ASSEMBLED PRICING

Includes headrail, cord roll supports, wall or ceiling brackets, counterweight (if requested), Velcro profile, chain, child safety tension device & warning label. When ordering, please specify chain drop length, wall or ceiling mount, control side, and number of cord roll supports needed. Freight is additional.



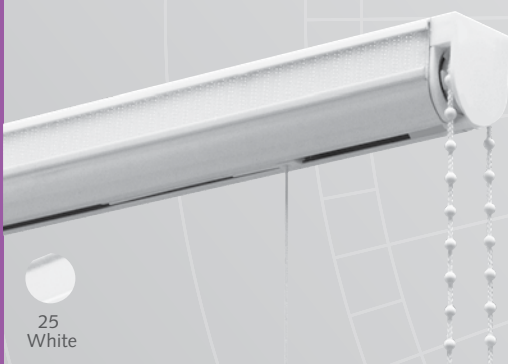







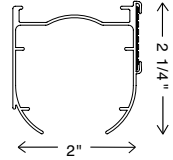

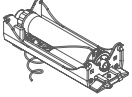



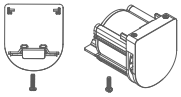



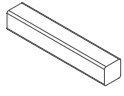



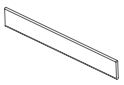





RBS XL ROMAN BLIND SYSTEM	first 4 feet	ea. add'l inch
White	\$193.60	\$4.27

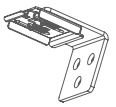

25
White

ROLLER SHADES & ROMANS

APOLLO BASIC | MERCURY DECORATIVE | ATLANTIS HEAVY DUTY | ROLLER SHADE FABRIC OPTIONS | RBS | **RBS XL** | BCS

RBS XL	COMPONENT	PRICE	RBS XL	COMPONENT	PRICE
●	 <p>44019-25 RBS XL Headrail 19' x 10 rails/bundle bundle = 190'</p>	\$13.55/ft.	●	 <p>39007-25 Velcro Tape 27 yds. per roll</p>	\$34.21/roll
●	 <p>44003-25 RBS XL Cord Roll Support</p>	\$11.84 ea.  \$9.86 ea. /box of 100	●	 <p>49006-25 Fiberglass Spines, 19' 3/16" diameter</p>	\$0.63/ft.  \$0.55/ft. /bundle of 250
●	 <p>44311-25 RBS XL Control Unit w/ End Cap & Screw 1:4 gear to 24 lbs.</p>	\$28.46 ea.  \$23.72 ea. /box of 100	●	 <p>49014-25 Plastic Snap Ring</p>	\$0.15 ea.  \$0.12 ea. /box of 5000
●	 <p>41119-90 19' Rod aluminum 3/16" x 3/16"</p>	\$3.25/ft.  \$2.71/ft. /bundle of 5	●	 <p>49013-25 Plastic Ring Cord Guide</p>	\$0.15 ea.  \$0.12 ea. /box of 5000
●	 <p>49005-25 Counterweight, 19' aluminum 1" x 1/8"</p>	\$3.01/ft.  \$2.39/ft. /bundle of 20	●	 <p>Endless Chain 25 white plastic or 90 nickel</p>	<p>49020-25, 90, 29" \$2.69 ea. 49021-25, 90, 39" \$3.13 ea. 49022-25, 90, 49" \$3.87 ea. 49023-25, 90, 59" \$4.30 ea. 49024-25, 90, 69" \$4.53 ea. 49025-25, 90, 79" \$4.66 ea. 49026-25, 90, 89" \$4.81 ea. 49027-25, 90, 99" \$5.22 ea.</p>
●	 <p>31116-25 Velcro Profile w/ Hook Tape, 13.1'</p>	\$5.72/ft.  \$4.75/ft. /bundle of 20	●	 <p>76047-90 Metal Ball Chain Stopper</p>	\$0.68 ea.
●	 <p>44004-90 RBS XL Ceiling Bracket nickel plated</p>	\$4.52 ea.  \$3.77 ea. /box of 100	●	 <p>79005-00 Clear Ball Chain Stopper</p>	\$1.34 ea.  \$1.12 ea. /box of 500
●	 <p>44033-90 RBS XL Wall Bracket nickel plated</p>	\$11.84 ea.  \$9.86 ea. /box of 100	●	 <p>49501-00 Tension Device For child safety</p>	\$10.32 ea.  \$8.59 ea./box 250
●	 <p>49008-25 Shade Leveler</p>	\$0.67 ea.  \$0.57 ea. /box of 1000			

 BREAK PACK PRICING  - Prices with this designation indicate a 20% up charge for broken pack quantities.

ROLLER SHADES & ROMANS

APOLLO BASIC | MERCURY DECORATIVE | ATLANTIS HEAVY DUTY | ROLLER SHADE FABRIC OPTIONS | RBS | RBS XLS | **BCS**

ROMANS BCS MOTORIZED



Scan for more information on the FOREST BCS Blind Contract System

BCS BLIND CONTRACT SYSTEM

- A heavy duty motorized blind system best suited for medium to heavy weight draperies.
- Aluminum, white, powder coated extrusion.
- Maximum weight is 45 lbs per motor and 8.75 lbs per cord roll. Maximum width is 120".
- Ultra quiet <44dB and easy to install.
- The Forest BCS tubular motor includes a 10 year warranty.











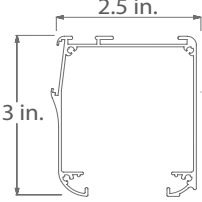











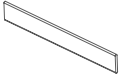



ASSEMBLED PRICING

Includes headrail, cord roll supports, brackets, counterweight (if requested), Velcro profile, motor and Diamond Sense remote or wall switch. When ordering, please specify motor side, wall or ceiling mount, and number of cord roll supports needed. Freight is additional.

BCS BLIND CONTRACT SYSTEM	first 3 feet	ea. add'l foot
Standard Motor	\$1,515.15	\$105.20

ROLLER SHADES & ROMANS

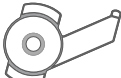
APOLLO BASIC | MERCURY DECORATIVE | ATLANTIS HEAVY DUTY | ROLLER SHADE FABRIC OPTIONS | RBS | RBS XLS | **BCS**

BCS MOT	COMPONENT	PRICE	BCS MOT	COMPONENT	PRICE
●	 <p>61019-25 BCS Headrail white 19' aluminum extrusion</p>	\$15.21/ft.	●	 <p>62100-25 BCS Center Support 2" x 2.25"</p>	\$21.79 ea.  \$18.15 ea. /box of 25
●	 <p>61119-25 BCS 8-Angle Tube, 19'</p>	\$6.41/ft.	●	 <p>49008-00 Shade Leveler</p>	\$0.67 ea.  \$0.57 ea. /box of 1000
●	 <p>62309-25 BCS End Caps left & right</p>	\$7.46 ea.  \$6.23 ea. /box of 25	●	 <p>61125-25 BCS Velcro 7/8" x 4'</p>	\$19.98/ft.  \$16.64/ft. /bundle of 25
●	 <p>49006-25 Fiberglass Rod, 19'</p>	\$0.63/ft.  \$0.55/ft. /bundle of 250	●	 <p>49400-25 Shroud 73 yds. per roll</p>	\$355.45/roll
●	 <p>49005-25 Counterweight, 19' aluminum 1" x 1/8"</p>	\$3.01/ft.  \$2.39/ft. /bundle of 20	●	 <p>62901-25 Forest Tubular Motor built-in RF receiver, 35mm (1 3/8"), 110v, 6 Nm</p>	\$738.09 ea. 1/box
●	 <p>62000-25 BCS Cord Roll House & Drum contains 18' cord</p>	\$74.59 ea.  \$62.17 ea. /box of 25	●	 <p>52931-25D white 59D black +10% Diamond Sense Remote RF, 15 channel w/ holder, Range 98'</p>	\$434.19 ea. 1/box
●	 <p>62200-25 BCS Tube Support place on open end of tube</p>	\$37.68 ea.  \$31.40 ea. /box of 25	●	 <p>52933-25 white 59 black +10% Diamond Sense Wall Switch 2 channel</p>	\$213.73 ea. 1/box
●	 <p>63003-25 BCS Swivel Wall Bracket</p>	\$23.16 ea.  \$19.30 ea. /box of 25	●	 <p>52947-25 Wireless Connector One-way transmitter to control drapery by third party app or by home automation. Use with Forest Shuttle & tubular motors.</p>	\$268.91 ea. 1/box
●	 <p>33007-25 BCS Swivel Ceiling Bracket</p>	\$1.30 ea.  \$1.08 ea. /box of 200	●	 <p>52955-25 Bond Bridge Pro</p>	\$379.00 ea. 1/box No discounts on this item

 **BREAK PACK PRICING**  - Prices with this designation indicate a 20% up charge for broken pack quantities.

ROMANS BCS MOTORIZED



BENDS & CURVES, BATONS, WORKROOM and EASYFLEX

BENDS/CURVES

Tracks, H-Rail & Motorized Rails



BATONS

Fiberglass, Acrylic, Metal & Wood

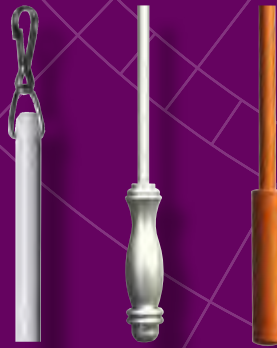



In this section find out more about bending and curving options at our facility or yours. Also consider our wide range of batons and other items for your workroom. Beyond traditional ripplefold tape, the Forest Easyflex System allows you to easily customize the fold depth of your ripplefold drapery.

WORKROOM

Stiffeners, Snap Tape, Lubricant & more



EASYFLEX

Custom fold depth system



BENDING & CURVING

BENDS & CURVES | BATONS | WORKROOM | EASYFLEX



CUSTOM BENDING & CURVING

- Forest will custom bend and curve our drapery hardware to your exact specifications. Or, bend and curve at your workroom with our equipment.
- All bend and curve orders require a template at actual size. Mail to Forest Drapery Hardware, 2500 Donn Drive, Cartersville GA 30120, Attn: Customer Service.
- Polished Chrome and wood foil finishes cannot be bent or curved. Satin Nickel and Bronze finishes may be slightly distorted at the site of the bend/curve.

BEND/CURVE THESE TRACKS, DECORATIVE METAL H-RAIL, AND MOTORIZED SYSTEMS



CS TRACK
p. 3-6



CCS TRACK
p. 7-8



KS TRACK
p. 11-12



DS TRACK
p. 11-12



FMS TRACK
p. 95-96



DRESDEN TRAVERSE & MOTORIZED TRAVERSE p. 63-64
MOTORIZED p. 103-104
Polished Chrome and wood foil finishes cannot be bent or curved



DEVENTER CRS & MRS CRS p. 67-68
MRS p. 107-108

PRICING

Bends: \$25.00/bend
Curves: \$20.00/ft.



Minimum Charge: \$100.00
Crating Fee: \$55.00/rod

KS/DS BENDING

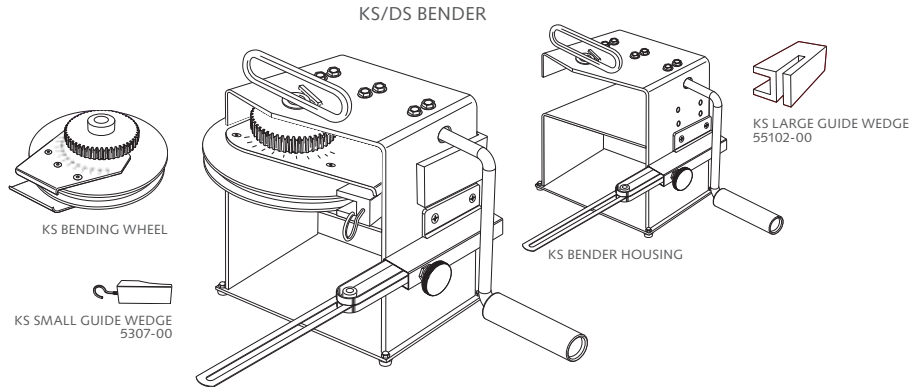

Scan for a video showing how to set up the KS/DS Bender

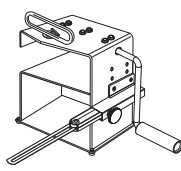

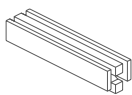
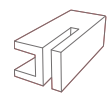
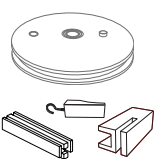
KS & DS	COMPONENT	PRICE	KS & DS	COMPONENT	PRICE
•	 KS/DS Housing Unit 5001-00	\$1,911.92 ea.	•	 Small Guide Wedge 5307-00 KS (pictured) 5308-00 DS white 5309-00 DS grey Both DS wedges are required.	\$152.93 ea. \$155.47 ea. \$155.47 ea.
•	 Bending Strips 5302-00 KS 5312-00 DS	\$33.18 ea. \$135.77 ea.	•	 Large Guide Wedge 55102-00 KS (pictured) 55103-00 DS white 55104-00 DS grey Both DS wedges are required.	\$244.68 ea. \$209.96 ea. \$209.96 ea.
•	 Bending Wheel Sets Includes wheel, wedges, and bending strips. 55401-00 KS 55402-00 DS	\$1,107.88/set \$2,439.86/set			

BENDING & CURVING







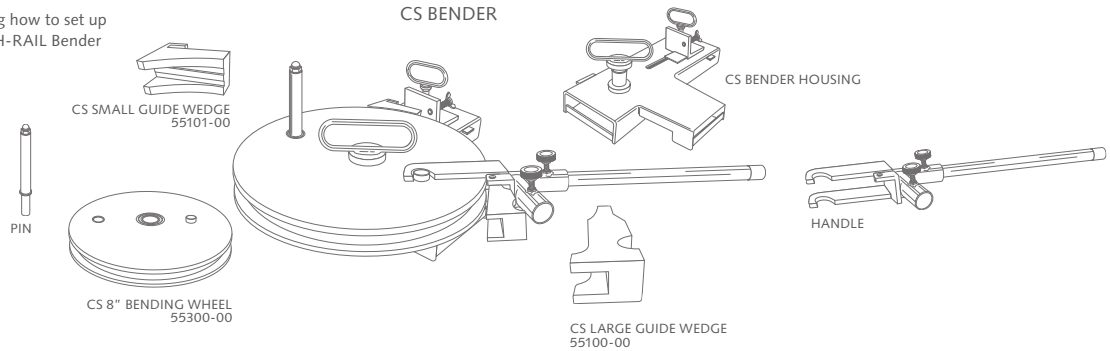

BENDS & CURVES | BATONS | WORKROOM | EASYFLEX

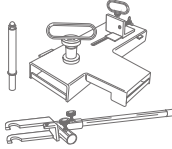
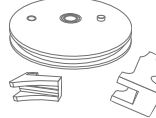
CS/CCS/FMS/H-RAIL BENDING









Scan for a video showing how to set up the CS/CCS/RTS/FMS/H-RAIL Bender

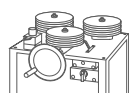
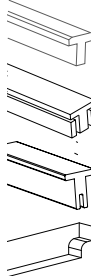

CS, CCS, FMS, H-RAIL	COMPONENT	PRICE	CS, CCS, FMS, H-RAIL	COMPONENT	PRICE
• 	CS/CCS/FMS/H-RAIL Housing Unit with handle & pin 55002-00	\$2,283.35 ea.	• 	Bending Wheels w/ wedges 55300-00 CS/CCS/FMS 55310-00 H-Rail	\$3,168.81 ea. \$3,168.83 ea.
• 	CS Bending Strip 55302-00	\$163.12 ea.	• 	Small Guide Wedge 55101-00 CS/CCS/FMS 55315-00 H-Rail	\$1,410.81 ea. \$1,410.81 ea.
• 	CCS Bending Strip 55303-00	\$163.13 ea.	• 	Large Guide Wedge 55100-00 CS/CCS/FMS 55316-00 H-Rail	\$1,410.81 ea. \$1,410.81 ea.
• 	FMS Bending Strip 55306-00	\$74.26 ea.	• 	Extension Arm for handle 55317-00	\$146.07 ea.
• 	H-Rail Bending Strip 55314-00	\$207.09 ea.	• 	Stand for CS Bender 55318-00	\$1,329.53 ea.

KS/DS/CS/CCS/FMS/H-RAIL CURVING





























CURVING	COMPONENT	PRICE	CURVING	COMPONENT	PRICE
• 	Electronic Continuous Curver 110 Volt curver for accurate and high output curing. Wheels not included. 5004-00	\$24,559.57 ea.	• 	Curving Strips, 23'	
• 	Curving Wheels, set of 3 5304-00 KS 5306-00 DS 5305-00 CS/CCS/FMS 55311-00 H-Rail	\$2,284.48/set \$1,733.14/set \$2,389.91/set \$1,474.97/set	• 	55308-00 KS	\$160.03 ea.
			• 	55304-00 DS/CCS	\$163.13 ea.
			• 	55307-00 CS/FMS	\$284.11 ea.
			• 	55313-00 H-Rail	\$144.54 ea.

BATONS

BENDS & CURVES | **BATONS** | WORKROOM | EASYFLEX







BATONS

BATONS FIBERGLASS, ACRYLIC, ADA & COMPONENTS

BATONS	COMPONENT	PRICE	BATONS	COMPONENT	PRICE
●	 snap  adaptor 3/8" Fiberglass Baton Must order screw separately		●	 snap  adaptor 1/2" Clear Acrylic Baton Must order screw separately	
	36" 54110-25 white w/ snap \$9.26 ea.  54310-25 white w/ adaptor \$7.72 ea./box 100			36" 54510-00 w/ snap \$13.25 ea.  54710-00 w/ adaptor \$11.03 ea./box 100	
	54110-59, 81, 90 w/ snap \$16.18 ea.  \$13.49 ea./box 100			48" 54511-00 w/ snap \$25.90 ea.  54711-00 w/ adaptor \$21.59 ea./box 100	
	48" 54111-25 white w/ snap \$12.31 ea.  54311-25 white w/ adaptor \$10.25 ea./box 100			60" 54512-00 w/ snap \$29.04 ea.  54712-00 w/ adaptor \$24.20 ea./box 100	
	54111-59, 81, 90 w/ snap \$19.28 ea.  \$16.07 ea./box 100			72" 54513-00 w/ snap \$38.76 ea.  54713-00 w/ adaptor \$32.29 ea./box 100	
	60" 54112-25 white w/ snap \$19.33 ea.  54312-25 white w/ adaptor \$16.09 ea./box 100			ADA Clear Acrylic Baton	
	54112-59, 81, 90 w/ snap \$25.29 ea.  \$21.06 ea./box 100			 adaptor 48" 54911-00 w/ adaptor \$68.90 ea.  \$57.43 ea./box 20	
	72" 54113-25 white w/ snap \$22.35 ea.  54313-25 white w/ adaptor \$18.63 ea./box 100			60" 54912-00 w/ adaptor \$79.78 ea.  \$66.49 ea./box 20	
	54113-59, 81, 90 w/ snap \$29.34 ea.  \$24.47 ea./box 100			 9013-00 Baton Holder, clear acrylic \$2.46 ea. 1,000/pkg	
	84" 54114-25 white w/ snap \$46.75 ea.  \$38.97 ea./box 100			 54001-16 Baton Snap \$0.40 ea. 1,000/pkg	
	96" 54115-25 white w/ snap \$46.75 ea.  \$38.97 ea./box 100			 9015-00 Hex Head Shoulder Screw \$0.57 ea. for baton w/ adaptor 200/bag	
	● Colors available for 3/8" Fiberglass Batons  25 White  59 Black  81 Bronze  90 Grey			 54000-16 D-Ring \$0.79 ea. 1,000/pkg	

 BREAK PACK PRICING  - Prices with this designation indicate a 20% up charge for broken pack quantities.











BATONS DECORATIVE METAL & WOOD

 <p>29MWAND-XX 40" Metal Baton see all finishes p. 55 \$101.40 ea.</p>	 <p>29AWAND-16 40" Round Metal Baton Stainless Steel \$106.65 ea.</p>	 <p>29SWAND-16 40" Square Metal Baton Stainless Steel \$112.30 ea.</p>	 <p>29IWAND-XX 40" Wrought Iron Baton see all finishes p. 59 \$90.18 ea.</p>	 <p>19WWAND-XX 40" Wood Baton see all finishes p. 83 \$24.47 ea. unfinished \$29.39 ea. finished \$54.72 ea. antiqued</p>	 <p>19CWAND-XX 40" Modern Baton see all finishes p. 83 \$24.47 ea. unfinished \$29.39 ea. finished \$54.72 ea. antiqued</p>
---	--	---	---	--	--

WORKROOM & FES

BENDS & CURVES | BATONS | **WORKROOM** | **EASYFLEX**

WORKROOM COMPONENTS

WORKROOM	COMPONENT	PRICE	WORKROOM	COMPONENT	PRICE
●	 9009-00 Large Stiffener w/ grommet Adjustable for ceiling or wall	\$1.41 ea.  \$1.17 ea. /bag 500	●	 1502-00 Spray Lubricant	\$47.11 ea.
●	 9011-00 Small Stiffener w/ grommet For sheers	\$1.20 ea.  \$1.00 ea. /bag 1000	●	 9100-00 Channel Protector fits CS, KS & DS Tracks	\$17.72 ea.
●	 9003-25 00 Clear, 59 Black + 10% 1" Snap Tape for Ripplefold 4 1/4" OC spacing	\$7.01/yd.  \$583.16 /roll 100 yd	●	 52500-00 Corded Assembly Tool	\$110.78 ea.
			●	 5000-00 Track Opener	\$63.93 ea.

 BREAK PACK PRICING  - Prices with this designation indicate a 20% up charge for broken pack quantities.











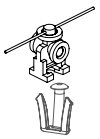

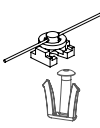

FES® FOREST EASYFLEX SYSTEM

- Fold depth is fully customizable with Easyflex tape and carriers.
- Use with any traversing system and your choice of ripplefold masters.
- Ceiling space required is equal to the spacing between the hook placement in the Easyflex tape.



Scan for more information on the FOREST FES Easyflex System

FES	COMPONENT	PRICE	FES	COMPONENT	PRICE
●	 2107-25 60%, 2 5/8" OC 2106-25 80%, 2 3/8" OC 2105-25 100%, 2 1/8" OC 2108-25 120%, 1 7/8" OC	\$1.83 ea.  \$1.52 ea. /box 500	●	 2116-25 Easywave Square Carrier, 80% use with 9039-25 Easyflex End Hook	\$1.35 ea.  \$1.12 ea. /box 1000
●	 2114-25 60%, 2 5/8" OC 2111-25 80%, 2 3/8" OC 2112-25 100%, 2 1/8" OC 2115-25 120%, 1 7/8" OC	\$1.47 ea.  \$1.23 ea. /roll of 500	●	 9039-25 Easyflex End Hook	\$0.36 ea.  \$0.29 ea. /box 1000
●	 9037-25 Easyflex Hook use with 210X-25 and 211X-25 carriers	\$1.18 ea.  \$0.98 ea. /box 500	●	 9036-00 Easyflex Tape 3" wide, 9/16" spacing	\$5.24/yd.  \$524.39 /roll 100 yds

 BREAK PACK PRICING  - Prices with this designation indicate a 20% up charge for broken pack quantities.



DECORATIVE METAL Collections



TAVIRA

- 1 1/8" Outdoor Metal Pole Sets
- 1 1/8" Outdoor Metal Traversing System

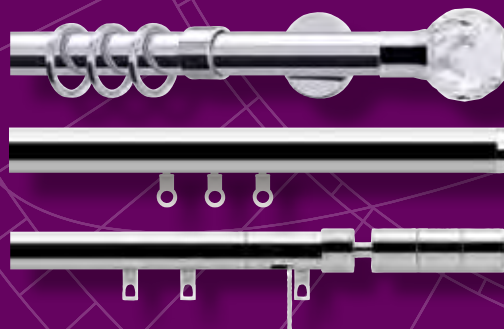

DRESDEN

- 1 1/8" Brass Pole Sets
- 1 1/8" Baton Draw Traversing Sets
- 1 1/8" Cord Draw Traversing Sets



MOTOR CONTROL
P. 103-106

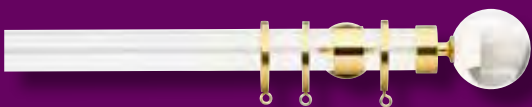

GLASGOW

- 1 3/8" Acrylic Pole Sets

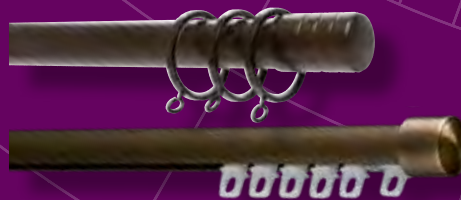

DEVENTER

- 1 1/8" Deco Pole Sets
- 1 1/8" CRS® Traversing Sets



MOTOR CONTROL
P. 107-108



Our decorative metal collections offer the perfect combination of style and functionality. With a wide variety of designs from contemporary to traditional, and many stunning finishes, you are sure to find the right hardware for your room.



LISBON
1 3/16" Brass Pole Sets



FRANKFURT
1" Square Rail Traversing Sets



AVEIRO
1 3/16" Steel Pole Sets



HANOVER
1 1/4" x 1 3/4" Traversing Sets

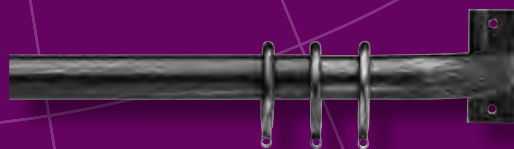

PORTO
3/4" & 1 3/16" Wrought Iron Pole Sets



STUTTGART
Rectangle and Oval Rail Traversing Sets

METAL

TAVIRA | GLASGOW | DRESDEN | DEVENTER DECO | LISBON | AVEIRO | PORTO | DRESDEN | DEVENTER CRS | FRANKFURT | HANOVER | STUTTGART

OUTDOOR METAL TAVIRA POLE SETS



TAVIRA OUTDOOR POLE SETS

1 1/8" Aluminum Powder Coated Pole Sets
Recommended weight is 4 lbs/ft. depending on application.



Scan for more information on
FOREST TAVIRA POLE SETS



1 1/8" Tavira Outdoor Pole Set in 59 Black

AVAILABLE FINISHES XX = finish color



25
White



59
Black



90
Grey



2031SMP-XX
1 1/8" Tavira Pole, 14'
Cannot be spliced
\$50.91/ft.

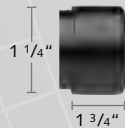

2130END-XX
Tavira End Cap
\$27.74 ea.



2230CIR-XX
Tavira Closed Bracket
\$72.60 ea.



53412-XX
Inside Mount Bracket
\$110.78 ea.

METAL

TAVIRA | GLASGOW | DRESDEN | DEVENTER DECO | LISBON | AVEIRO | PORTO | DRESDEN | DEVENTER CRS | FRANKFURT | HANOVER | STUTTGART

TAVIRA OUTDOOR TRAVERSING

1 1/8" Aluminum Powder Coated Traversing System
Recommended weight is 4 lbs/ft. depending on application.

- 1 1/8" outdoor designer traversing system for one- or two-way pinch pleat or ripplefold drapery. Can be used with the EasyFlex system on page 44.
- Wall or ceiling mount. Maximum length is 14' and this system cannot be spliced.
- Maximum weight is 4 lbs per foot depending on application.

ASSEMBLED PRICING

Includes rail, end cap finial, carriers, end stop, masters, and wall or ceiling brackets. Indicate pinch pleat or ripplefold when ordering. Freight is additional.

TAVIRA OUTDOOR TRAV	first 4 feet	ea. add'l foot
Single	\$695.11	\$86.09



1 1/8" Tavira Outdoor Traversing System in 89 Graphite





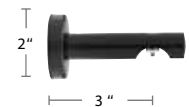
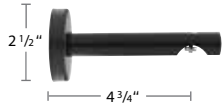
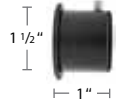
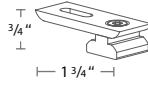
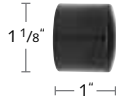



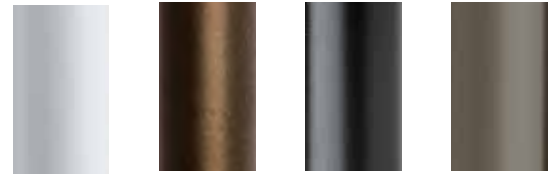



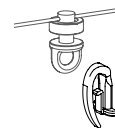





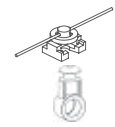

Scan for more information on
FOREST TAVIRA TRAVERSING

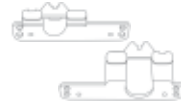
TAVIRA	COMPONENT	PRICE
• 	51419-XX 1 1/8" Aluminum Rail 14', cannot splice	\$19.34/ft.
• 	53401-XX Single Wall Bracket 3" P	\$70.04 ea. 2/box
• 	53402-XX Extended Single Wall Bracket 4 3/4" P	\$92.22 ea. 2/box
• 	53412-XX Inside Mount Bracket	\$110.78 ea. 2/box
• 	53408-XX 25 white, 59 black Flush Ceiling Bracket Cannot use finials	\$25.56 ea.
• 	52430-XX End Cap Finial	\$48.47 ea. 10/box

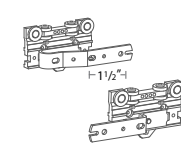
AVAILABLE FINISHES XX = finish color

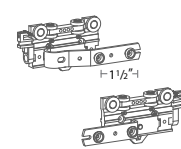

25 White 81 Antique Bronze 89 Graphite 95 Taupe

TAVIRA	COMPONENT	PRICE
• 	2116-25 Easywave Square Carrier, 80% use with 9039-25 Easyflex End Hook	\$1.35 ea.  \$1.12 ea. /box 1000
• 	9039-25 Easyflex End Hook	\$0.36 ea.  \$0.29 ea. /box 1000
• 	9036-00 Easyflex Tape 3" wide, 9/16" spacing	\$5.24/yd.  \$524.39 /roll 100 yds
• 	Two Piece Connected Snap Carrier w/ Square Base, in plastic sleeve. Use 1 1/4" snap tape 2114-25, 59 black 60% fullness, 2 5/8" OC 2111-25, 59 black, 65 brown 80% fullness, 2 3/8" OC	\$1.47 ea.  \$1.23 ea. /roll of 500 Colors other than white +10%
• 	52004-25 Low Profile Ball Bearing	\$1.84 ea.  \$1.51 ea. /box of 1000
• 	B8809-23-00 Overlap R B8809-24-00 Underlap L 59 black + 10% Plastic Snap Master	\$15.46 ea.  \$12.86 ea. /box of 25
• 	52402-25 Overlap R 52404-25 Underlap L 59 black + 10% Standard Multi-Functional Master Stainless Steel arms	\$19.07 ea.  \$15.89 ea. /box of 100
• 	52402-25A Overlap R 52404-25A Underlap L 59A black + 10% Standard Multi-Functional Master w/ stainless steel snaps and arms	\$22.89 ea.  \$19.07 ea. /box of 100
• 	V799-2-00 End Stop	\$1.07 ea.  \$0.88 ea. /box of 100

METAL

TAVIRA | **GLASGOW** | DRESDEN | DEVENTER DECO | LISBON | AVEIRO | PORTO | DRESDEN | DEVENTER CRS | FRANKFURT | HANOVER | STUTTART

METAL POLE SETS GLASGOW ACRYLIC



GLASGOW COLLECTION

1 3/8" Acrylic Pole Sets
Recommended weight is 4 lbs/ft. depending on application.



Scan for more information on
FOREST GLASGOW POLE SETS

AVAILABLE FINISHES XX = finish color

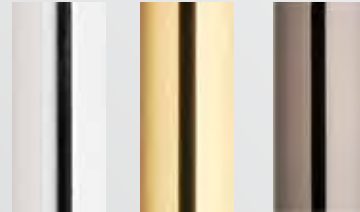

22
Polished
Chrome

23
Polished
Brass

89
Graphite



3335AHP-00
1 3/8" Hollow Acrylic Pole, 10'
\$43.62/ft.



3035RWB-XX
Recess Wall Bracket
\$82.33 ea.



3035CYL-XX
Cylinder Bracket
\$103.18 ea.

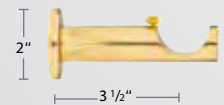

3035CYE-XX
Extended Cylinder Bracket
\$123.82 ea.



3035CCB-XX
Closed Bracket
\$123.82 ea.



3035CWB-XX
Extended Closed Bracket
\$135.06 ea.



3035RIN-XX
Metal Ring w/ Eyelet
& Plastic Insert
\$12.95 ea.

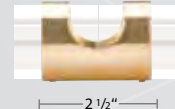

3035CON-XX
Joining Bracket
\$69.34 ea.

GLASGOW COLLECTION (CONTINUED)

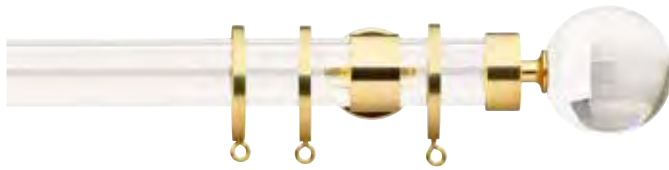

Clear Acrylic Glasgow Pole with Sphere Finial and Polished Brass Collar



Clear Acrylic Glasgow Pole, Pillbox Finial with Polished Chrome Collar, Rings & Bracket



Clear Acrylic Glasgow Pole, Cylinder Finial with Graphite Collar

GLASGOW COLLECTION FINIALS

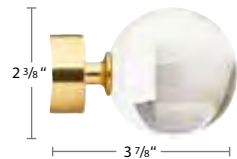

3035BAL-XX
Sphere Finial
\$173.52 ea.

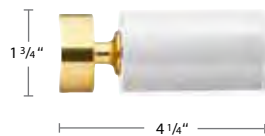

3035CIL-XX
Cylinder Finial
\$173.51 ea.

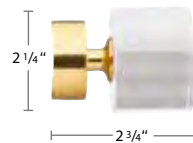

3035PIL-XX
Pillbox Finial
\$136.00 ea.

METAL

TAVIRA | GLASGOW | **DRESDEN** | DEVENTER DECO | LISBON | AVEIRO | PORTO | DRESDEN | DEVENTER CRS | FRANKFURT | HANOVER | STUTTART

METAL POLE SETS DRESDEN



DRESDEN COLLECTION

1 1/8" Brass Pole Sets with Finials or a French Return
Recommended weight is 4 lbs/ft. depending on application.



Scan for more information on
FOREST DRESDEN POLE SETS

AVAILABLE FINISHES XX = finish color

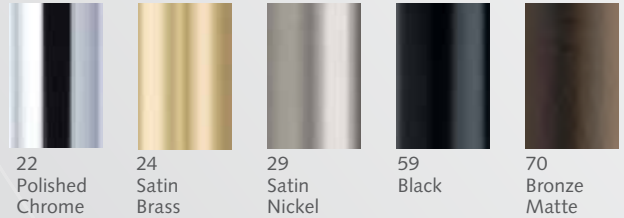

B801-28-XX
1 1/8" Brass Pole, 16' 4"
\$33.67/ft.

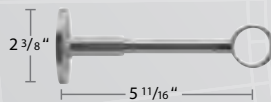

B11950-28-XX
Single Wall or Ceiling Bracket
\$262.97 ea.



B11952-28-XX
Double Wall Bracket
\$364.11 ea.



B11598-28-L-XX
B11598-28-R-XX
not avail. in 70 Bronze Matte
French Return, 3 1/8" P
\$206.37 ea.



B400-80-XX
Support Bracket for French Return
\$202.18 ea.

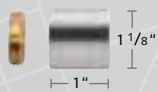

B122028-XX
Inside Mount Bracket
\$113.26 ea.



B125930-XX
Flat Ring w/ Eyelet
Includes Plastic Insert
\$14.22 ea.

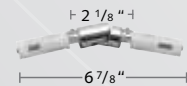

B122928-XX
Swivel Elbow
\$215.35 ea.



2030SPL-23
Splice
\$17.08 ea.

METAL

TAVIRA | GLASGOW | **DRESDEN** | DEVENTER DECO | LISBON | AVEIRO | PORTO | DRESDEN | DEVENTER CRS | FRANKFURT | HANOVER | STUTTART

DRESDEN COLLECTION (CONTINUED)



29 Satin Nickel Dresden Pole with French Return



22 Polished Chrome Dresden Pole with Ardea Finial and Socket



24 Satin Brass Dresden Pole with Napoli Finial

DRESDEN COLLECTION FINIALS

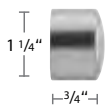

B124028-XX
End Cap Finial
\$56.65 ea.

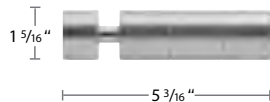

B690-XX
Pescara Finial
\$319.62 ea.

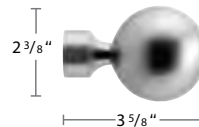

B3362-XX
Alassio Finial
\$323.64 ea.

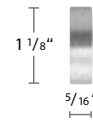

B124128-XX
Alea Finial
\$80.37 ea.

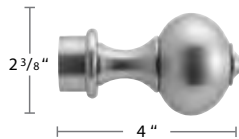

B650-XX
Verona Finial
\$438.48 ea.



B610-XX
Napoli Finial
\$401.96 ea.



B660-22, 24, 29, 70
Roma Finial
\$567.08 ea.

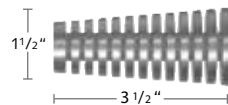

B3521-28-XX
Ischia Finial
\$277.76 ea.



B3389-100
Ardea Finial \$540.64 ea.
B3389/1-XX
Socket for Ardea Finial \$108.72 ea.

METAL

TAVIRA | GLASGOW | DRESDEN | **DEVENTER DECO** | LISBON | AVEIRO | PORTO | DRESDEN | DEVENTER CRS | FRANKFURT | HANOVER | STUTTART



METAL POLES SETS DEVENTER DECO

DEVENTER DECO COLLECTION

1 1/8" Aluminum Pole Sets with plastic inlay on pole and inside rings
Recommended weight is 4 lbs/ft. depending on application.



Scan for more information on
FOREST DEVENTER DECO POLE SETS

AVAILABLE FINISHES XX = finish color



29
Satin
Nickel

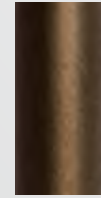

81
Antique
Bronze



89
Graphite



95
Taupe



51819-XX
1 1/8" Aluminum Pole, 19"
\$16.91/ft.



53401-XX
Single Bracket
3" P
\$70.04 ea. 2/box



53402-XX
Extended Single Bracket
4 3/4" P
\$92.22 ea. 2/box



53406-XX
Double Bracket
6 1/4" P
Do not use with Ripplefold
\$132.36 ea. 2/box



53407-XX
Extended Double Bracket
7 3/4" P
Use with Ripplefold
\$148.24 ea. 2/box

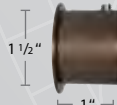

53412-XX
Inside Mount Bracket
\$110.78 ea. 2/box



2330FRI-XX
Flat Ring
\$12.97 ea.

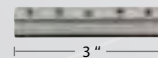

53413-90
Deventer Rail Connector
aluminum, 3"
\$23.76 ea. 25/box

DEVENTER DECO COLLECTION (CONTINUED)

Ultra quiet and smooth operation with a plastic inlay on the top of the pole and inside the rings.



29 Satin Nickel Deventer Deco Pole with Notched Finial



89 Graphite Deventer Deco Pole with Notched Finial



95 Taupe Deventer Deco Pole with Notched Finial

DEVENTER COLLECTION FINIALS

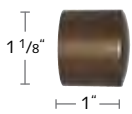

52430-XX
Deventer End Cap Finial
\$48.47 ea. 10/box



52431-XX
Deventer Ball Finial
\$101.60 ea. 10/box

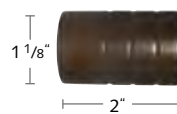

52432-XX
Deventer Notched Finial
\$55.97 ea. 10/box

METAL

TAVIRA | GLASGOW | DRESDEN | DEVENTER DECO | LISBON | AVEIRO | PORTO | DRESDEN | DEVENTER CRS | FRANKFURT | HANOVER | STUTTART

METAL POLE SETS LISBON



LISBON COLLECTION

1 3/16" Brass Pole Sets with Finials or a French Return
Recommended weight is 4 lbs/ft. depending on application.



Scan for more information on
FOREST LISBON POLE SETS

AVAILABLE FINISHES XX = finish color



22 Polished Chrome

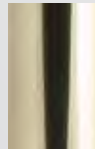

23 Polished Brass



24 Satin Brass



27 Rose Gold



29 Satin Nickel



32 Antique Bronze



36 Oil Rubbed Bronze

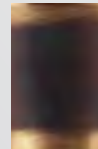

66 French Bronze

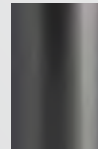

89 Graphite

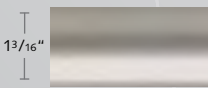

2030SMP-XX
1 3/16" Brass Pole, 16'
\$46.28/ft.



2230FRE-XX
French Return
Wall Bracket, 3 1/2"P
\$85.45 ea.



2230TOL-XX
Toledo Open
Wall Bracket
\$70.02 ea.

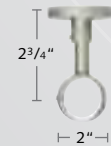

2230CIR-XX
Irati Closed
Ceiling Bracket
\$72.60 ea.

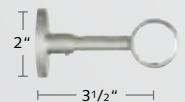

2230IRA-XX
Irati Closed
Wall Bracket
\$83.19 ea.

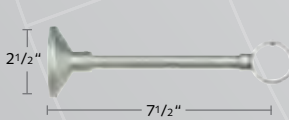

2230EVI-XX
Viana Extended Closed
Wall Bracket
\$76.56 ea.



2230DIR-XX
Double Irati
Wall Bracket
Not for use w/ grommets
\$90.74 ea.



2230OIM-XX
Open Inside Mount
Wall Bracket
\$39.67 ea.

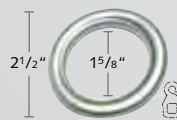

2330SHR-XX
Plastic Lined
Smooth Hollow Ring
w/ Clip-on Eyelet
\$6.87 ea.



2330FRI-XX
Flat Ring
\$12.97 ea.

METAL

TAVIRA | GLASGOW | DRESDEN | DEVENTER DECO | LISBON | AVEIRO | PORTO | DRESDEN | DEVENTER CRS | FRANKFURT | HANOVER | STUTTGART

LISBON COLLECTION (CONTINUED)

22 Polished Chrome Lisbon Pole with French Return



24 Satin Brass Lisbon Pole with French Return



27 Rose Gold Lisbon Pole with Velate Finial



66 French Bronze Lisbon Pole with Toscana Finial



29 Satin Nickel Lisbon Pole with Velate Finial



LISBON COLLECTION FINIALS, BATON, SPLICE & HOLDBACK

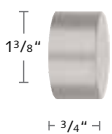

2130END-XX
End Cap Finial
\$27.74 ea.

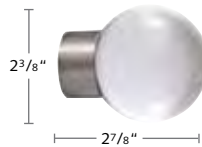

2130ACR-XX
Acrylic Ball Finial
\$87.70 ea.

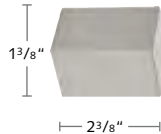

2130BLO-XX
Block Finial
\$69.58 ea.

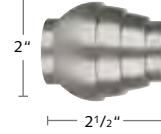

2130TIE-XX
Tier Finial
\$73.52 ea.

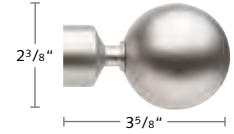

2130VEL-XX
Velate Finial
\$81.95 ea.

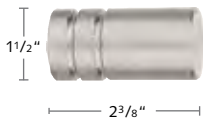

2130CIL-XX
Cilindro Finial
\$77.56 ea.

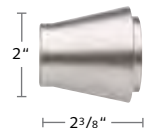

2130INC-XX
Inca Finial
\$77.91 ea.

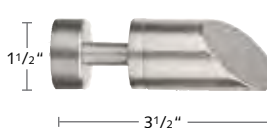

2130SLA-XX
Slant Finial
\$56.31 ea.

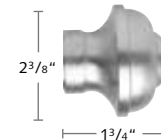

2130TOS-XX
Toscana Finial
\$58.06 ea.



29MWAND-XX
Metal Control Baton 40"
\$101.40 ea.
See all batons p. 43



2030SPL-23
Pole Splice
\$17.08 ea.

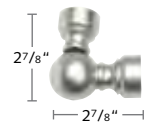

2130SWI-XX
Swivel Corner Connector
\$113.53 ea.

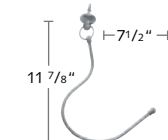

26SWING-XX
Swing Holdback
\$97.60 ea.

METAL

TAVIRA | GLASGOW | DRESDEN | DEVENTER DECO | LISBON | **AVEIRO** | PORTO | DRESDEN | DEVENTER CRS | FRANKFURT | HANOVER | STUTTGART

METAL POLE SETS AVEIRO STAINLESS STEEL



AVEIRO COLLECTION

1 3/16" Stainless Steel Pole Sets with Finials or a French Return
Recommended weight is 4 lbs./ft. depending on application.



Scan for more information on
FOREST AVEIRO POLE SETS

AVAILABLE FINISHES XX = finish color



16
Stainless Steel
19'



25
Shiny White
19'



59
Matte Black
16'

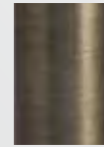

87
Bronze Brilliant
16'



88
Shiny Black
19'



2030SMP-XX
1 3/16" Brass Pole
\$46.28/ft.



2230FRE-XX
French Return
Wall Bracket, 3 1/2" P
\$85.45 ea.

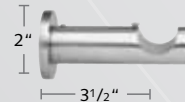

2230CYL-XX
Cylinder Wall Bracket
\$113.73 ea.

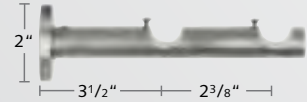

2230DCB-XX
Cylinder Double Wall Bracket
Not for use w/ grommets
\$185.94 ea.



2230CYC-XX
Cylinder Ceiling Bracket
\$126.16 ea.



2230CIR-XX
Irati Closed Ceiling Bracket
\$72.60 ea.



2230IRA-XX
Irati Closed Wall Bracket
\$83.19 ea.

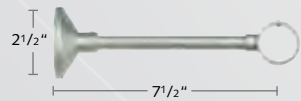

2230EVI-XX
Viana Extended Closed
Wall Bracket
\$76.56 ea.

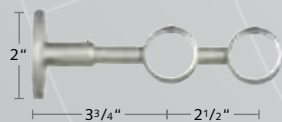

2230DIR-XX
Double Irati Wall Bracket
Not for use w/ grommets
\$90.74 ea.



2230OIM-XX
Open Inside Mount
Bracket
\$39.67 ea.



2230FRI-XX
Flat Ring
w/ Plastic Insert
\$12.97 ea.

AVEIRO COLLECTION (CONTINUED)

16 Stainless Steel Aveiro Pole with 87 Bronze Brilliant Components

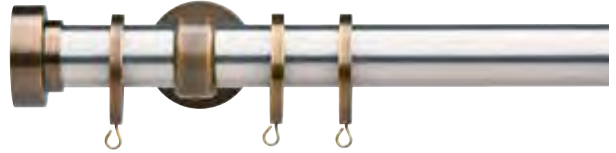

87 Bronze Brilliant Aveiro Pole with French Return



16 Stainless Steel Aveiro Pole with Acrylic Ball Finial



59 Black Matte Aveiro Pole, End Cap and Rings



AVEIRO COLLECTION FINIALS, BATON, SPLICE & HOLDBACK

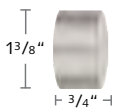

2130END-XX
End Cap Finial
\$27.74 ea.

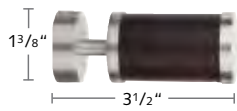

2130CLM-16 Round Brn
2130CLB-16 Round Blk
only in -16 Stainless Steel
\$119.51 ea.

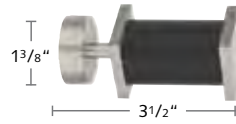

2130CUM-16 Square Brn
2130CUB-16 Square Blk
only in -16 Stainless Steel
\$119.13 ea.

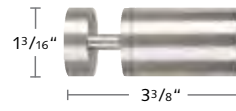

2130ROL-XX
Steel Rollenbild Finial
\$90.32 ea.

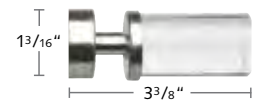

2130ROL-00 Stainless
2130ROL-XXC
Clear Rollenbild Finial
\$104.90 ea.



2130ACR-XX
Acrylic Ball Finial
\$87.70 ea.

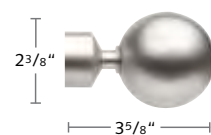

2130VEL-XX
Velate Finial
\$81.95 ea.



2130POP-XX
Pop Finial
\$67.19 ea.

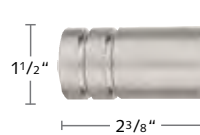

2130CIL-XX
Cilindro Finial
\$77.56 ea.



2130INC-XX
Inca Finial
\$77.91 ea.

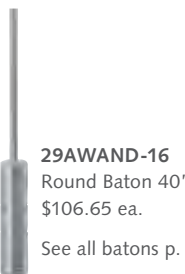

29AWAND-16
Round Baton 40"
\$106.65 ea.
See all batons p. 43



29SWAND-16
Square Baton 40"
\$112.30 ea.
See all batons p. 43



2030SPL-23
Pole Splice
\$17.08 ea.

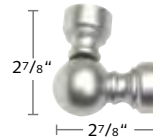

2130SWI-XX
Swivel Corner Connector
\$113.53 ea.

METAL

TAVIRA | GLASGOW | DRESDEN | DEVENTER DECO | LISBON | AVEIRO | **PORTO** | DRESDEN | DEVENTER CRS | FRANKFURT | HANOVER | STUTTGART

METAL POLE SETS 3/4" PORTO WROUGHT IRON



PORTO 3/4" COLLECTION

3/4" Wrought Iron Pole Sets
Recommended weight is 4 lbs./ft. depending on application.



Scan for more information on
FOREST PORTO POLE SETS

AVAILABLE FINISHES XX = finish color



33
Black Silver

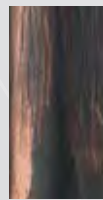

35
Grey Copper



37
Sand Gold



38
Rust



40
Graphite Rust



59
Black

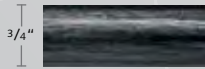

220SIR-XX
3/4" Wrought Iron Pole, 13'
\$9.50/ft.



2220CEI-XX
3/4" Ceiling Bracket
\$33.20 ea.

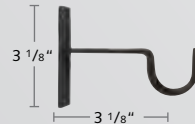

2220YOR-XX
3/4" York Single Open Bracket
\$34.90 ea.

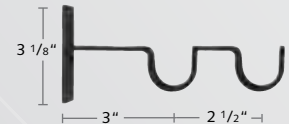

2220DYO-XX
3/4" York Double Open Bracket
\$46.38 ea.

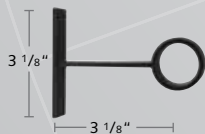

2220CYR-XX
3/4" York Wall/Ceiling Closed Bracket
\$38.31 ea.

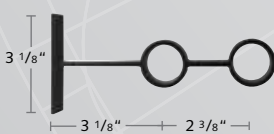

2220DCY-XX
3/4" York Double Wall Closed Bracket
\$51.62 ea.



2220ILA-XX
3/4" Inside Mount Bracket
\$20.16 ea.



2320IRI-XX
3/4" Smooth Ring w/ Plastic Insert
\$5.45 ea.

PORTO 3/4" COLLECTION (CONTINUED)

37 Sand Gold Porto Pole with Caracola Finial



35 Grey Copper Porto Pole with Bola Finial



38 Rust Porto Pole with Berry Finial



40 Graphite Rust Porto Pole with Troia Finial

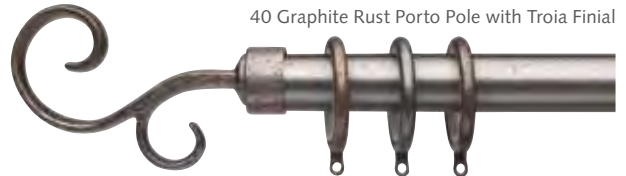

3/4" PORTO COLLECTION FINIALS, BATON & SPLICE

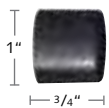

2120IEN-XX
3/4" End Cap Finial
\$14.30 ea.

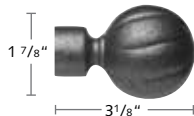

2120BOL-XX
3/4" Bola Finial
\$41.11 ea.

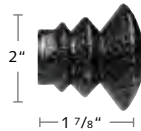

2120EVE-XX
3/4" Everest Finial
\$38.64 ea.

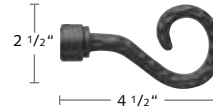

2120BER-XX
3/4" Berry Finial
\$25.98 ea.



2120CAR-XX
3/4" Caracola Finial
\$41.10 ea.

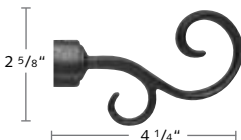

2120TRO-XX
3/4" Troia Finial
\$28.73 ea.



2120MAR-XX
3/4" Marte Finial
\$25.98 ea.



29IWAND-XX
Iron Baton 40"
\$90.18 ea.
See all batons p. 43



2020SPL-23
Pole Splice
\$17.08 ea.



2120SWI-XX
3/4" Swivel Corner Connector
\$71.70 ea.

METAL

TAVIRA | GLASGOW | DRESDEN | DEVENTER DECO | LISBON | AVEIRO | **PORTO** | DRESDEN | DEVENTER CRS | FRANKFURT | HANOVER | STUTTGART

METAL POLE SETS 1 3/16" PORTO WROUGHT IRON



PORTO 1 3/16" COLLECTION

1 3/16" Wrought Iron Pole Sets
Recommended weight is 4 lbs/ft. depending on application.



Scan for more information on
FOREST PORTO POLE SETS

AVAILABLE FINISHES XX = finish color



33
Black Silver

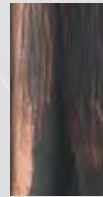

35
Grey Copper



37
Sand Gold

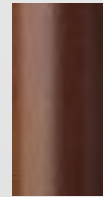

38
Rust

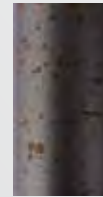

40
Graphite Rust



59
Black



2030SIR-XX
1 3/16" Wrought Iron Pole, 13'
\$12.86/ft.



2230CEI-XX
1 3/16" Ceiling
Bracket
\$33.81 ea.

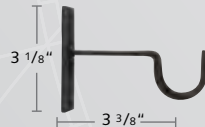

2230YOR-XX
1 3/16" York Single Open
Bracket
\$34.90 ea.

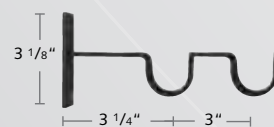

2230DYO-XX
1 3/16" York Double Open
Bracket
\$46.51 ea.

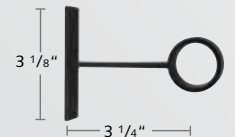

2230CYR-XX
1 3/16" York Single Closed
Bracket
\$38.40 ea.

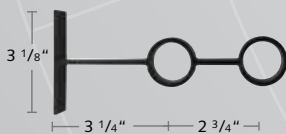

2230DCY-XX
1 3/16" York Double Closed
Bracket
\$51.16 ea.



2230ILA-XX
1 3/16" Inside Mount
Bracket
\$21.72 ea.



2230FRT-XX
1 3/16" French Return Bracket
3 3/8" P
\$43.10 ea.



2330IRI-XX
1 3/16" Smooth Ring
w/ Plastic Insert
\$10.82 ea.



2330FRI-XX
1 3/16" Flat Ring
w/ Plastic Insert
\$12.97 ea.

PORTO 1 3/16" COLLECTION (CONTINUED)

33 Black Silver Porto Pole with French Return Bracket



37 Sand Gold Porto Pole with Troia Finial and York Closed Bracket

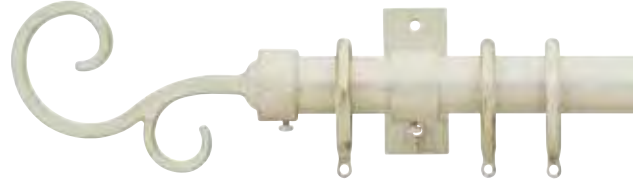

35 Grey Copper Porto Pole with York Open Bracket and Caracola Finial



59 Black Porto Pole with Ball Finial and York Closed Bracket



1 3/16" PORTO COLLECTION FINIALS & BATON



2130IEN-XX
1 3/16" End Cap Finial
\$16.28 ea.

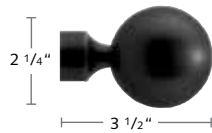

2130BAL-XX
1 3/16" Ball Finial
\$71.17 ea.

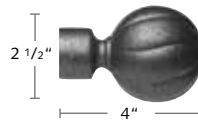

2130BOL-XX
1 3/16" Bola Finial
\$71.17 ea.

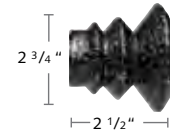

2130EVE-XX
1 3/16" Everest Finial
\$42.93 ea.



2130BER-XX
1 3/16" Berry Finial
\$28.85 ea.

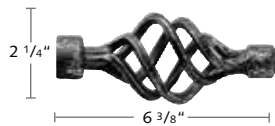

2130CAR-XX
1 3/16" Caracola Finial
\$74.32 ea.

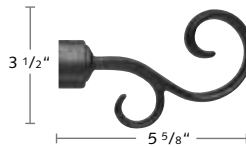

2130TRO-XX
1 3/16" Troia Finial
\$31.91 ea.



2130MAR-XX
1 3/16" Marte Finial
\$28.85 ea.

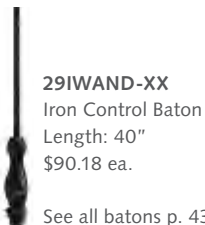

29IWAND-XX
Iron Control Baton
Length: 40"
\$90.18 ea.

See all batons p. 43



2030SPL-23
Pole Splice
\$17.08 ea.



2130SWI-XX
1 3/16" Swivel Corner
Connector
\$113.53 ea.

METAL

TAVIRA | GLASGOW | DRESDEN | DEVENTER DECO | LISBON | AVEIRO | PORTO | **DRESDEN** | DEVENTER CRS | FRANKFURT | HANOVER | STUTTGART

METAL TRAVERSING DRESDEN



Scan for more information on FOREST DRESDEN TRAVERSING



DRESDEN TRAVERSING



MOTOR CONTROL
P. 103-106

- 1 1/8" heavy duty hand or baton draw h-rail system for one- or two-way pinch pleat or ripplefold drapery.
- Wall or ceiling mount. See bracket count below.

Up to 60" = 2 brackets	121-180" = 4 brackets
61-120" = 3 brackets	181-240" = 5 brackets
- Maximum weight is 4 lbs per foot depending on application.
- Bendable – Dresden traversing can be curved and reversed curved using an 8" radius or continuous curve. An exact size template is required. See page 41-42 for more information.
- See corded version on pages 65-66 and motorized version pages 103-106.

ASSEMBLED PRICING

Includes rail, end cap finial, carriers, end stop, masters, wall or ceiling brackets, and 36" white fiberglass baton (See all batons p. 43). Indicate pinch pleat or ripplefold when ordering. Freight is additional.

DRESDEN TRAVERSING	first 4 feet	ea. add'l foot
Single	\$873.98	\$133.31
Double	\$1,747.91	\$266.39

AVAILABLE FINISHES XX/XXX = finish color

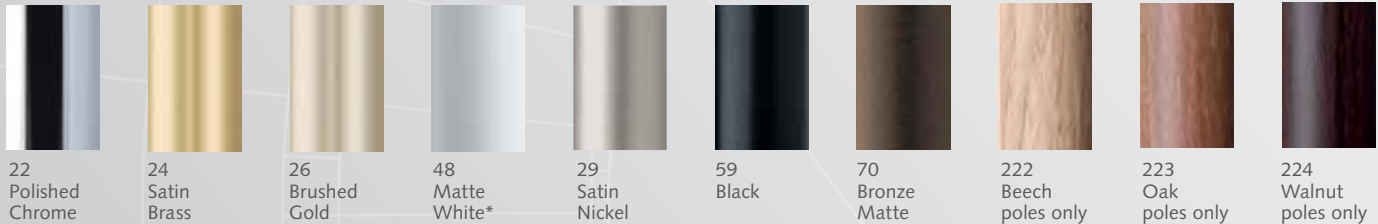

DRESDEN TRAVERSING FINIALS

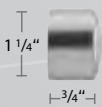

B124028-XX
End Cap Finial
\$56.65 ea.

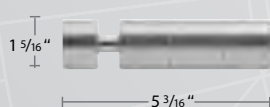

B690-XX
Pescara Finial
\$319.62 ea.

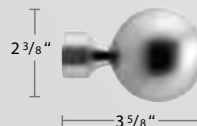

B3362-XX
Alassio Finial
\$323.64 ea.

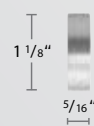

B124128-XX
Alea Finial
\$80.37 ea.

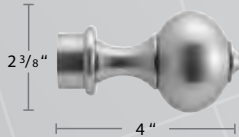

B650-XX
Verona Finial
\$438.48 ea.



B610-XX
Napoli Finial
\$401.96 ea.

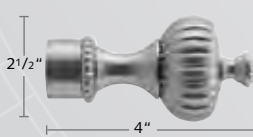

B660-22, 24, 29, 70
Roma Finial
\$567.08 ea.

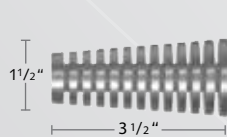

B3521-28-XX
Iscia Finial
\$277.76 ea.
not available in 26 Brushed Gold







B3389-100
Ardea Finial \$540.64 ea.
B3389/1-XX
Socket for Ardea Finial \$108.72 ea.



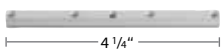
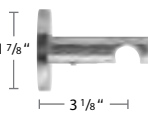
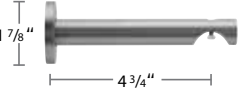
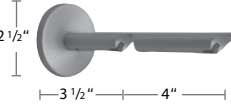
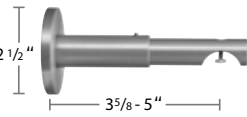
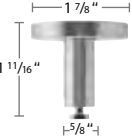
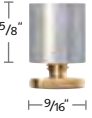
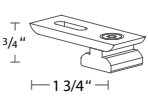







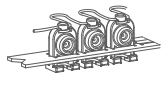



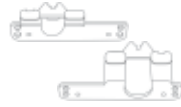

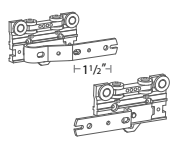
* Some components in 48 Matte White may have longer lead times, please call sales for more information.

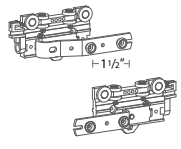
METAL

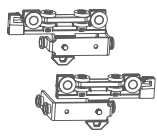
TAVIRA | GLASGOW | DRESDEN | DEVENTER DECO | LISBON | AVEIRO | PORTO | **DRESDEN** | DEVENTER CRS | FRANKFURT | HANOVER | STUTTART

DRESDEN	COMPONENT	PRICE
	B808-28-XX 1 1/8" Aluminum H-Rail 19' 7"	\$34.51/ft. \$41.39/ft. foiled 222, 223, 224
	B899-4-00 1 1/8" & 1 9/16" Rail Connector	\$48.05 ea.
	B11670-XX Single Wall Bracket	\$178.02 ea.
	B11670-120-XX Extended Single Wall Bracket	\$189.07 ea.
	B11672-190-XX Double Wall Bracket	\$214.43 ea.
	B11670-V-XX Adjustable Wall Bracket	\$262.96 ea.
	B11873-50-XX Ceiling Bracket	\$110.40 ea.
	B11873-15-XX Ceiling Bracket 5/8" Extension	\$68.78 ea.
	53408-XX 22 chrome, 25 white, 24 gold, 29 satin nickel, 59 black Flush Ceiling Bracket Cannot use finials	\$25.56 ea.
	B11598-28-L-22, 24, 29, 59 B11598-28-R-22, 24, 29, 59 French Return, 3 1/8" P	\$206.37 ea.

 **BREAK PACK PRICING**  - Prices with this designation indicate a 20% up charge for broken pack quantities.

DRESDEN	COMPONENT	PRICE
	Wheeled Connected Snap Carriers on plastic strip 2207-25 60% fullness, 2 5/8" OC 2206-25 24 gold, 59 black, 65 brown, 90 grey 80% fullness, 2 3/8" OC 2205-25 100% fullness, 2 1/8" OC 2208-25 120% fullness, 1 7/8" OC	\$2.37 ea.  \$1.98 ea. /box of 500 Colors other than white +10%
	52002-25 24 gold, 59 black, 65 brown, 90 grey + 10% Slim Line Ball Bearing Carrier	\$0.82 ea.  \$0.67 ea. /box of 1000
	B8809-23-00 Overlap R B8809-24-00 Underlap L 59 black + 10% Plastic Snap Master	\$15.46 ea.  \$12.86 ea. /box of 25
	52502-25 Overlap R 52504-25 Underlap L 59 black + 10% Standard Multi-Functional Master Use stiffener w/ exposed baton or hooks w/ hidden baton	\$8.80 ea.  \$7.34 ea. /box of 100
	52502-25A Overlap R 52504-25A Underlap L 59A black + 10% Standard Multi-Functional Master w/ snaps	\$10.66 ea.  \$8.89 ea. /box of 100
	52411-25A Butt R 52412-25A Butt L 24A gold, 59A black, 65A brown, 90A grey Wheeled Butt Master w/snap adaptor Designed for hidden baton	\$37.74 ea.  \$31.44 ea. /box of 50 Colors other than white +10%
	B122928-XX Swivel Elbow	\$215.35 ea.
	V799-2-00 End Stop	\$1.07 ea.  \$0.88 ea. /box of 100
	Fiberglass batons in 36", 48", 60", 72", 84" and 96" lengths and these colors. See all batons page 43.	
	White Black Bronze Grey	

METAL

TAVIRA | GLASGOW | DRESDEN | DEVENTER DECO | LISBON | AVEIRO | PORTO | **DRESDEN** | DEVENTER CRS | FRANKFURT | HANOVER | STUTTGART

METAL TRAVERSING DRESDEN 1 1/8" CORDED



Scan for more information on
FOREST DRESDEN 1 1/8" CORDED



1 1/8" Dresden Corded Traversing System in 29 Satin Nickel

DRESDEN 1 1/8" CORDED



MOTOR CONTROL
P. 103-106

- Light duty cord draw system for one- or two-way pinch pleat or ripplefold drapery.
- Wall or ceiling mount. See bracket count below.

Up to 60" = 2 brackets	121-180" = 4 brackets
61-120" = 3 brackets	181-240" = 5 brackets
- Maximum weight is 50 lbs. Not designed to pull heavy weight draperies.
- See the hand drawn version on pages 63-64 and the motorized version on pages 103-106.

ASSEMBLED PRICING

Includes rail, cord pulley in finished housing, carriers, masters, wall or ceiling brackets and child safety device. Indicate pinch pleat or ripplefold when ordering. Freight is additional.

DRESDEN 1 1/8" CORDED	first 4 feet	ea. add'l foot
1 1/8" Single	\$1,131.07	\$140.89
1 1/8" Double	\$2,262.14	\$281.79

AVAILABLE FINISHES XX = finish color



- 22
Polished
Chrome
- 26
Brushed
Gold
- 48
Matte
White*
- 29
Satin
Nickel
- 59
Black

* Some components in 48 Matte White may have longer lead times, please call sales for more information.

DRESDEN CORDED FINIALS



B124028-XX
End Cap Finial
\$56.65 ea.

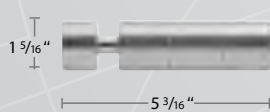

B690-XX
Pescara Finial
\$319.62 ea.

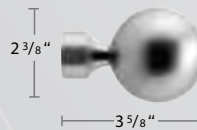

B3362-XX
Alassio Finial
\$323.64 ea.

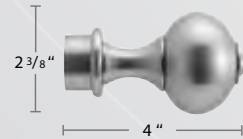

B650-XX
Verona Finial
\$438.48 ea.



B610-XX
Napoli Finial
\$401.96 ea.

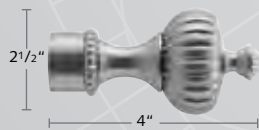

B660-22, 24, 29, 70
Roma Finial
\$567.08 ea.

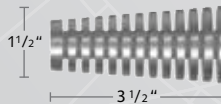

B3521-28-XX
Iscia Finial
\$277.76 ea.
not available in 26 Brushed Gold

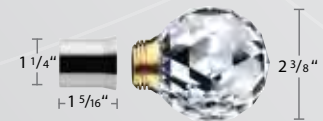

B3389-100
Ardea Finial \$540.64 ea.
B3389/1-XX
Socket for Ardea Finial \$108.72 ea.

METAL

TAVIRA | GLASGOW | DRESDEN | DEVENTER DECO | LISBON | AVEIRO | PORTO | **DRESDEN** | DEVENTER CRS | FRANKFURT | HANOVER | STUTTART

DRESDEN CORD	COMPONENT	PRICE	DRESDEN CORD	COMPONENT	PRICE
●	 B809-28-XX 1 1/8" Aluminum Rail for Cord Draw 19' 7"	\$57.65/ft.	●	 Two Piece Connected Snap Carrier w/ Square Base, in plastic sleeve. Use 1 1/4" snap tape 2114-25, 59 black 60% fullness, 2 5/8" OC 2111-25, 59 black, 65 brown, 90 grey 80% fullness, 2 3/8" OC 2112-25, 59 black 100% fullness, 2 1/8" OC 2115-25, 59 black 120% fullness, 1 7/8" OC	\$1.47 ea. \$1.23 ea. /roll of 500 Colors other than white +10%
●	 B11687-XX 1 1/8" Cord Pulley in finished housing Finial optional	\$109.25 ea.	●	 52008-25 59 black +10% Slim Line Klick Carrier Allows drapery to hang and conceal track	\$1.31 ea. \$1.08 ea. /box of 250
●	 B11686-XX 1 1/8" Return Pulley in finished housing Finial optional	\$142.02 ea.	●	 52009-25 Ball Bearing Carrier	\$1.84 ea. \$1.51 ea. /bundle of 250
●	 B899-4-00 Rail Connector	\$48.05 ea.	●	 52508-25 Overlap R 52509-25 Underlap L 59 black, 90 grey +10% Swivel Foot Multi-Functional Master	\$15.51 ea. \$12.95 ea. /box of 100
●	 B11670-XX 1 1/8" Single Wall Bracket	\$178.02 ea.	●	 52508-25A Overlap R 52509-25A Underlap L 59 black, 90 grey +10% Swivel Foot Multi-Functional Master w/ snaps	\$18.39 ea. \$15.33 ea. /box of 100
●	 B11672-190-XX 1 1/8" Double Wall Bracket	\$214.43 ea.	●	 52510-25 59 black, 90 grey +10% Cord Connector	\$2.86 ea. \$2.38 ea. /box of 100
●	 B11873-50-XX Ceiling Bracket	\$110.40 ea.	●	 9004-25 3.2mm Cord 333.34 yds./roll	\$2.46/yd. \$820.28/roll
●	 B11873-15-XX Ceiling Bracket 5/8" Extension	\$68.78 ea.	●	 49501-00 Tension Device For child safety	\$10.32 ea. \$8.59 ea. /box of 250
●	 53408-XX 22 chrome, 25 white, 29 satin nickel, 59 black Flush Ceiling Bracket Cannot use finials	\$25.56 ea.			

BREAK PACK PRICING - Prices with this designation indicate a 20% up charge for broken pack quantities.

METAL TRAVERSING DRESDEN 1 1/8" CORDED

METAL

TAVIRA | GLASGOW | DRESDEN | DEVENTER DECO | LISBON | AVEIRO | PORTO | DRESDEN | **DEVENTER CRS** | FRANKFURT | HANOVER | STUTTGART

METAL TRAVERSING DEVENTER CRS



Scan for more information on
FOREST DEVENTER CRS TRAVERSING

DEVENTER CRS® TRAVERSING



59 Black Deventer CRS Rail with Ball Finial in front & End Cap in back



81 Antique Bronze Deventer CRS Rail with End Cap Finial



29 Satin Nickel Deventer CRS Rail with Notched Finial

- 1 1/8" heavy duty baton draw h-rail system for one- or two-way pinch pleat or ripplefold drapery.
- Wall or ceiling mount. See bracket count below.
 - Up to 60" = 2 brackets
 - 61-120" = 3 brackets
 - 121-180" = 4 brackets
 - 181-240" = 5 brackets
- Maximum weight is 4 lbs per foot depending on application.
- Bendable – Deventer CRS traversing can be curved and reversed curved using an 8" radius or continuous curve. An exact size template is required. See page 41-42 for more information.
- See motorized version on pages 107-108.

ASSEMBLED PRICING

Includes rail, end cap finial, carriers, end stop, masters, wall or ceiling brackets and 36" white fiberglass baton (See all batons p. 43). Indicate pinch pleat or ripplefold when ordering. Freight is additional.

DEVENTER CRS TRAVERSING	first 4 feet	ea. add'l foot
Single	\$695.11	\$86.09
Double	\$1,390.23	\$172.15

AVAILABLE FINISHES XX = finish color



24 Satin Brass



25 White



29 Satin Nickel



59 Black



81 Antique Bronze













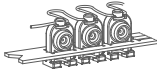

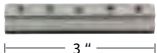



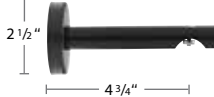
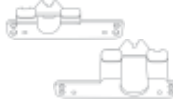

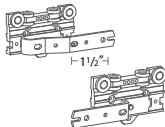

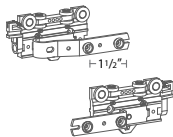
89 Graphite

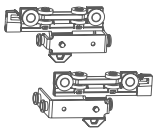

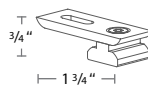

95 Taupe

METAL

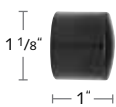
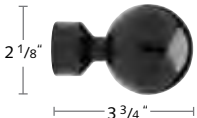
TAVIRA | GLASGOW | DRESDEN | DEVENTER DECO | LISBON | AVEIRO | PORTO | DRESDEN | **DEVENTER CRS** | FRANKFURT | HANOVER | STUTTGART

DEVENTER	COMPONENT	PRICE	DEVENTER	COMPONENT	PRICE
	51419-XX 1 1/8" Aluminum CRS Rail 19'	\$19.34/ft.		Wheeled Connected Snap Carriers on plastic strip 2207-25 60% fullness, 2 5/8" OC 2206-25, 24, 59, 65, 90 80% fullness, 2 3/8" OC 2205-25 100% fullness, 2 1/8" OC 2208-25 120% fullness, 1 7/8" OC	\$2.37 ea.  \$1.98 ea. /box of 500 Colors other than white +10%
	53413-90 Rail Connector aluminum, 3"	\$23.76 ea. 25/box		52002-25 24 gold, 59 black, 65 brown, 90 grey + 10% Slim Line Ball Bearing Carrier	\$0.82 ea.  \$0.67 ea. /box of 1000
	53401-XX Single Wall Bracket 3" P	\$70.04 ea. 2/box		52110-25 CRS Carrier UV-proof, synthetic material	\$0.55 ea.  \$0.47 ea. /box of 500
	53402-XX Extended Single Wall Bracket 4 3/4" P	\$92.22 ea. 2/box		B8809-23-00 Overlap R B8809-24-00 Underlap L 59 black + 10% Plastic Snap Master	\$15.46 ea.  \$12.86 ea. /box of 25
	53406-XX Double Wall Bracket 6 1/4" P Do not use w/ Ripplefold	\$132.36 ea. 2/box		52502-25 Overlap R 52504-25 Underlap L 59 black +10% Standard Multi-Functional Master Use stiffener w/ exposed baton or hooks w/ hidden baton	\$8.80 ea.  \$7.34 ea. /box of 100
	53407-XX Extended Double Wall Bracket 7 7/8" P Use w/ Ripplefold	\$148.24 ea. 2/box		52502-25A Overlap R 52504-25A Underlap L 59A black +10% Standard Multi-Functional Master w/ snaps	\$10.66 ea.  \$8.89 ea. /box of 100
	53412-XX Inside Mount Bracket	\$110.78 ea. 2/box		52411-25A Butt R 52412-25A Butt L 24A gold, 59A black, 65A brown, 90A grey Wheeled Butt Master w/snap adaptor Designed for hidden baton	\$37.74 ea.  \$31.44 ea. /box of 50 Colors other than white +10%
	53408-XX 22 chrome, 25 white, 24 gold, 29 satin nickel, 59 black Flush Ceiling Bracket Cannot use finials	\$25.56 ea.		2551-25 Small Extension Arm	\$5.24 ea.  \$4.35 ea. /box of 50
	53403-XX Bracket Extension	\$91.03 ea. 10/box		V799-2-00 End Stop	\$1.07 ea.  \$0.88 ea. /box of 100
	52430-XX End Cap Finial	\$48.47 ea. 10/box			
	52431-XX Ball Finial	\$101.60 ea. 10/box			
	52432-XX Not avail. in 25 white Notched Finial	\$55.97 ea. 10/box			

 **BREAK PACK PRICING**  - Prices with this designation indicate a 20% up charge for broken pack quantities.

METAL TRAVERSING DEVENTER CRS

METAL

TAVIRA | GLASGOW | DRESDEN | DEVENTER DECO | LISBON | AVEIRO | PORTO | DRESDEN | DEVENTER CRS | **FRANKFURT** | HANOVER | STUTT GART

METAL TRAVERSING FRANKFURT



Scan for more information on
FOREST FRANKFURT SQUARE RAIL



22 Polished Chrome Square Rail, Fina End Cap and Bracket



29 Satin Nickel Square Rail, Fina End Cap and Invisible Bracket



59 Black Square Rail with 22 Polished Chrome Fina End Cap and Bracket

AVAILABLE FINISHES XX = finish color



22
Polished
Chrome



48
Matte
White*



29
Satin
Nickel



59
Black

FRANKFURT SQUARE RAIL

- 1" traversing square rail system for one- or two-way pinch pleat or ripplefold drapery.
- Wall or ceiling mount. See bracket count below.
 - Up to 60" = 2 brackets
 - 61-120" = 3 brackets
 - 121-180" = 4 brackets
 - 181-240" = 5 brackets
- Maximum weight is 4 lbs per foot depending on application.

ASSEMBLED PRICING











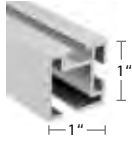
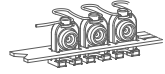

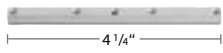
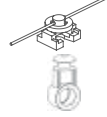

Includes rail, end cap finial, carriers, end stop, masters, wall or ceiling brackets and 36" white fiberglass baton (See all batons p. 43). Indicate pinch pleat or ripplefold when ordering. Freight is additional.

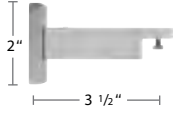
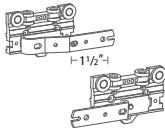
FRANKFURT SQUARE RAIL	first 4 feet	ea. add'l foot
Single	\$982.39	\$196.22
Double	\$1,964.76	\$331.07

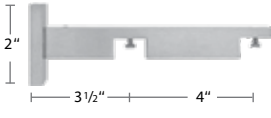
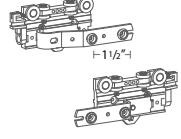
* Some components in 48 Matte White may have longer lead times, please call sales for more information.

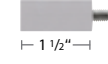
METAL

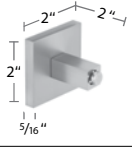
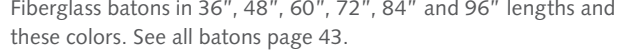
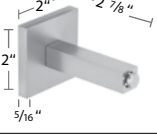
TAVIRA | GLASGOW | DRESDEN | DEVENTER DECO | LISBON | AVEIRO | PORTO | DRESDEN | DEVENTER CRS | **FRANKFURT** | HANOVER | STUTTGART

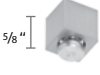
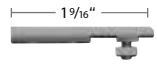
SQUARE	COMPONENT	PRICE	SQUARE	COMPONENT	PRICE
	B8082525-XX 1" Square Rail 19' 7"	\$63.55/ft.		Wheeled Connected Snap Carriers on plastic strip 2207-25 60% fullness, 2 5/8" OC 2206-25, 59 black, 90 silver 80% fullness, 2 3/8" OC 2205-25 100% fullness, 2 1/8" OC 2208-25 120% fullness, 1 7/8" OC	2.37 ea.  \$1.98 ea. /box of 500 Colors other than white +10%
	B899-4-00 1 1/8" & 1 9/16" Rail Connector	\$48.05 ea.		Two Piece Connected Snap Carrier w/ Square Base, in plastic sleeve. Use 1 1/4" snap tape 2114-25, 59 black 60% fullness, 2 5/8" OC 2111-25, 90 silver 80% fullness, 2 3/8" OC 2112-25, 59 black 100% fullness, 2 1/8" OC 2115-25, 59 black 120% fullness, 1 7/8" OC	\$1.47 ea.  \$1.23 ea. /roll of 500 Colors other than white +10%
	B1242525-XX Fina End Cap Finial	\$57.08 ea.		52002-25 59 black, 90 silver + 10% Slim Line Ball Bearing Carrier	\$0.82 ea.  \$0.67 ea. /box of 1000
	B11470-25-XX Wall Bracket	\$234.06 ea.		52502-25 Overlap R 52504-25 Underlap L 59 black + 10% Standard Multi-Functional Master Use stiffener w/ exposed baton or hooks w/ hidden baton	\$8.80 ea.  \$7.34 ea. /box of 100
	B11472-25-XX Double Wall Bracket	\$310.36 ea.		52502-25A Overlap R 52504-25A Underlap L 59A black + 10% Standard Multi-Functional Master w/ snaps	\$10.66 ea.  \$8.89 ea. /box of 100
	B11470-40-XX Bracket Extension for B11470-25-XX and B11472-25-XX	\$70.22 ea.		V799-2-00 End Stop	\$1.07 ea.  \$0.88 ea. /box of 100
	B11473-50-XX Ceiling Bracket/ Invisible Wall Bracket 2" Projection	\$123.11 ea.		Fiberglass batons in 36", 48", 60", 72", 84" and 96" lengths and these colors. See all batons page 43.	
	B11473-80-XX Ceiling Bracket/ Invisible Wall Bracket 2 7/8" Projection	\$127.72 ea.		White Black Bronze Grey	
	B11473-15-XX Ceiling Bracket 5/8" Extension	\$73.09 ea.			
	B11592-00 Flush Ceiling Bracket	\$21.56 ea.			

 **BREAK PACK PRICING**  - Prices with this designation indicate a 20% up charge for broken pack quantities.

METAL

TAVIRA | GLASGOW | DRESDEN | DEVENTER DECO | LISBON | AVEIRO | PORTO | DRESDEN | DEVENTER CRS | FRANKFURT | **HANOVER** | STUTTGART

METAL TRAVERSING HANOVER RAIL



Scan for more information on FOREST HANOVER RAIL



29 Satin Nickel Hanover Rail with Satin Nickel End Cap Finial

AVAILABLE FINISHES XX = finish color



22 Polished Chrome



48 Matte White



29 Satin Nickel



59 Black

HANOVER RAIL

- Contemporary rail system for one- or two-way pinch pleat or ripplefold drapery.
- Wall or ceiling mount. See bracket count below.
 - Up to 60" = 2 brackets
 - 61-120" = 3 brackets
 - 121-180" = 4 brackets
 - 181-240" = 5 brackets
- Maximum weight is 4 lbs per foot depending on application.









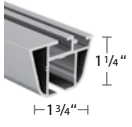
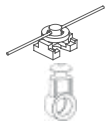

ASSEMBLED PRICING

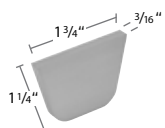

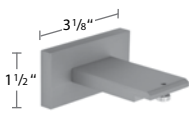
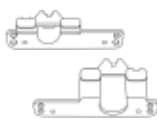
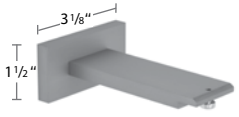
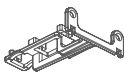
Includes rail, end cap finial, carriers, end stop, masters, wall or ceiling brackets and 36" white fiberglass baton (See all batons p. 43). Indicate pinch pleat or ripplefold when ordering. Freight is additional.

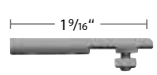
HANOVER RAIL	first 4 feet	ea. add'l foot
Single	\$1,307.68	\$281.62

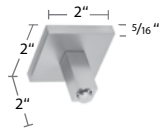
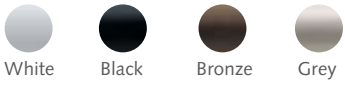
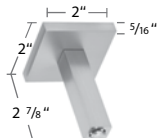
METAL

TAVIRA | GLASGOW | DRESDEN | DEVENTER DECO | LISBON | AVEIRO | PORTO | DRESDEN | DEVENTER CRS | FRANKFURT | **HANOVER** | STUTTGART

HANOVER	COMPONENT	PRICE	HANOVER	COMPONENT	PRICE
	B8223246-XX Hanover Profile 19' 7"	\$68.65/ft.		Two Piece Connected Snap Carrier w/ Square Base, in plastic sleeve. Use 1 1/4" snap tape 2114-25, 59 black 60% fullness, 2 5/8" OC 2111-25, 59 black, 90 grey 80% fullness, 2 3/8" OC 2112-25, 59 black 100% fullness, 2 1/8" OC 2115-25, 59 black 120% fullness, 1 7/8" OC	\$1.47 ea.  \$1.23 ea. /roll of 500 Colors other than white +10%
	B1243246-XX Hanover End Cap Finial	\$70.99 ea.		52004-25 Low Profile Ball Bearing	\$1.84 ea.  \$1.51 ea. /box of 1000
	B11260-90-XX Wall Bracket P = 3 3/4"	\$192.74 ea.		B8809-23-00 Overlap R B8809-24-00 Underlap L 59 black + 10% Plastic Snap Master	\$15.46 ea.  \$12.86 ea. /box of 25
	B11260-130-XX Extended Wall Bracket P = 4 3/4"	\$217.17 ea.		9040-25 Overlap R/L FES Master	\$6.22 ea.  \$5.18 ea. /box of 25
	B11592-00 Flush Ceiling Bracket	\$21.56 ea.		V799-2-00 End Stop	\$1.07 ea.  \$0.88 ea. /box of 100
	B11473-50-XX Ceiling Bracket 2" Projection	\$123.11 ea.		Fiberglass batons in 36", 48", 60", 72", 84" and 96" lengths and these colors. See all batons page 43. White Black Bronze Grey	
	B11473-80-XX Ceiling Bracket 2 7/8" Projection	\$127.72 ea.			
	B11473-15-XX Ceiling Bracket 5/8" Extension	\$73.09 ea.			

 **BREAK PACK PRICING**  - Prices with this designation indicate a 20% up charge for broken pack quantities.

METAL

TAVIRA | GLASGOW | DRESDEN | DEVENTER DECO | LISBON | AVEIRO | PORTO | DRESDEN | DEVENTER CRS | FRANKFURT | HANOVER | **STUTTGART**

METAL TRAVERSING STUTTGART RECTANGLE RAIL



Scan for more information on
FOREST RECTANGLE RAIL



22 Polished Chrome Rectangle Rail with 29 Satin Nickel Bracket and Square Finial with Spacer

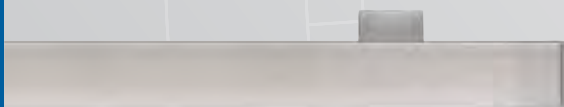

29 Satin Nickel Rectangle Rail with Satin Nickel End Cap Finial and Invisible Bracket

AVAILABLE FINISHES XX = finish color



22
Polished
Chrome

48
Matte
White*

29
Satin
Nickel

59
Black

* Some components in 48 Matte White may have longer lead times, please call sales for more information.

STUTTGART RECTANGLE RAIL

- Rectangle rail system for one- or two-way pinch pleat or ripplefold drapery.
- Wall or ceiling mount. See bracket count below.
 - Up to 60" = 2 brackets
 - 61-120" = 3 brackets
 - 121-180" = 4 brackets
 - 181-240" = 5 brackets
- Maximum weight is 4 lbs per foot depending on application.











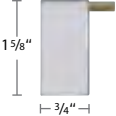
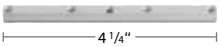
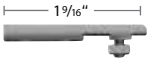
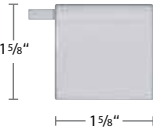
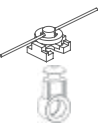

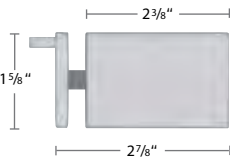

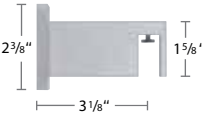
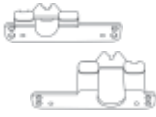

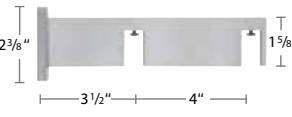
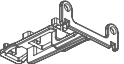
ASSEMBLED PRICING

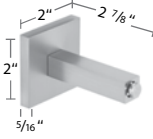

Includes rail, end cap finial, carriers, end stop, masters, wall or ceiling brackets and 36" white fiberglass baton (See all batons p. 43). Indicate pinch pleat or ripplefold when ordering. Freight is additional.

RECTANGLE RAIL	first 4 feet	ea. add'l foot
Single	\$1,048.93	\$227.74
Double	\$2,097.84	\$455.46

METAL

TAVIRA | GLASGOW | DRESDEN | DEVENTER DECO | LISBON | AVEIRO | PORTO | DRESDEN | DEVENTER CRS | FRANKFURT | HANOVER | **STUTT GART**

RECTANGLE	COMPONENT	PRICE	RECTANGLE	COMPONENT	PRICE
	B8084015-XX Rectangle Rail 19' 7"	\$51.41/ft.		B1224015-XX Inside Mount Bracket	\$145.65 ea.
	B899-4-00 Rail Connector	\$48.05 ea.		B11592-00 Flush Ceiling Bracket	\$21.56 ea.
	B11580-XX Square Finial	\$149.69 ea.		Two Piece Connected Snap Carrier w/ Square Base, in plastic sleeve. Use 1 1/4" snap tape	\$1.47 ea.  \$1.23 ea. /roll of 500
	B11581-XX Square Finial w/ Spacer	\$258.93 ea.		2114-25, 59 black 60% fullness, 2 5/8" OC 2111-25, 59 black, 90 grey 80% fullness, 2 3/8" OC 2112-25, 59 black 100% fullness, 2 1/8" OC 2115-25, 59 black 120% fullness, 1 7/8" OC	Colors other than white +10%
	B1254015-XX End Cap Finial	\$84.96 ea.			52002-25 59 black, 90 grey + 10% Slim Line Ball Bearing Carrier
	B11570-80-XX Single Wall Bracket	\$275.11 ea.		B8809-23-00 Overlap R B8809-24-00 Underlap L 59 black + 10% Plastic Snap Master	\$15.46 ea.  \$12.86 ea. /box of 25
	B11570-2-190-XX Double Wall Bracket	\$330.12 ea.		9040-25 Overlap R/L FES Master	\$6.22 ea.  \$5.18 ea. /box of 25
	B11473-80-XX Ceiling Bracket/ Invisible Wall Bracket 2 7/8" Projection	\$127.72 ea.		V799-2-00 End Stop	\$1.07 ea.  \$0.88 ea. /box of 100
	B11473-15-XX Ceiling Bracket 5/8" Extension	\$73.09 ea.	Fiberglass batons in 36", 48", 60", 72", 84" and 96" lengths and these colors. See all batons page 43.		
					
			White	Black	Bronze
					
			Grey		

 **BREAK PACK PRICING**  - Prices with this designation indicate a 20% up charge for broken pack quantities.

METAL

TAVIRA | GLASGOW | DRESDEN | DEVENTER DECO | LISBON | AVEIRO | PORTO | DRESDEN | DEVENTER CRS | FRANKFURT | HANOVER | **STUTTGART**

METAL TRAVERSING STUTTGART OVAL RAIL



Scan for more information on
FOREST STUTTGART OVAL RAIL



1 1/2" Oval Rail in 22 Polished Chrome with Sona End Cap

AVAILABLE FINISHES XX = finish color



22
Polished
Chrome



29
Satin
Nickel



59
Black

STUTTGART OVAL RAIL

- 1 1/2" traversing oval rail system for one- or two-way pinch pleat or ripplefold drapery.
- Wall or ceiling mount. See bracket count below.
 - Up to 60" = 2 brackets
 - 61-120" = 3 brackets
 - 121-180" = 4 brackets
 - 181-240" = 5 brackets
- Maximum weight is 4 lbs per foot depending on application.











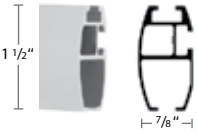
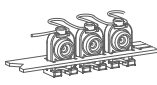

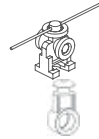

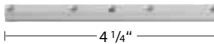

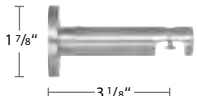
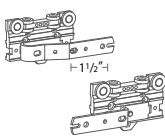
ASSEMBLED PRICING

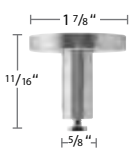
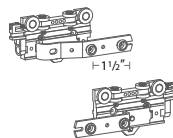

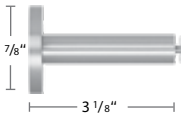
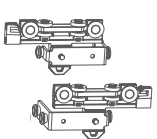
Includes rail, end cap finial, carriers, end stop, masters, wall or ceiling brackets and 36" white fiberglass baton (See all batons p. 43). Indicate pinch pleat or ripplefold when ordering. Freight is additional.

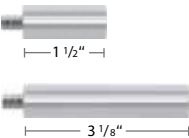
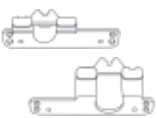
STUTTGART OVAL RAIL	first 4 feet	ea. add'l foot
Single	\$851.27	\$96.00
Double	\$1,702.55	\$192.00

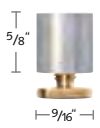
METAL

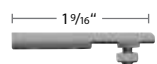
TAVIRA | GLASGOW | DRESDEN | DEVENTER DECO | LISBON | AVEIRO | PORTO | DRESDEN | DEVENTER CRS | FRANKFURT | HANOVER | **STUTT GART**

OVAL	COMPONENT	PRICE	OVAL	COMPONENT	PRICE
	B8084020-XX 1 1/2" Oval Rail 19' 7"	\$49.05/ft.		Wheeled Connected Snap Carriers on plastic strip 2207-25 60% fullness, 2 5/8" OC 2206-25, 59 black, 90 silver 80% fullness, 2 3/8" OC 2205-25 100% fullness, 2 1/8" OC 2208-25 120% fullness, 1 7/8" OC	\$2.37 ea.  \$1.98 ea. /box of 500 Colors other than white +10%
	B1254022-XX 1 1/2" Sona End Cap 1/4" Projection	\$90.54 ea.		Wheeled Connected Snap Carrier in plastic sleeve 2107-25, 59 black 60% fullness, 2 5/8" OC 2106-25, 59 black, 90 silver 80% fullness, 2 3/8" OC 2105-25, 59 black 100% fullness, 2 1/8" OC 2108-25, 59 black 120% fullness, 1 7/8" OC	\$1.83 ea.  \$1.52 ea. /roll of 500 Colors other than white +10%
	B899-4-00 1 1/8" & 1 9/16" Rail Connector	\$48.05 ea.		52002-25 59 black, 90 silver + 10% Slim Line Ball Bearing Carrier	\$0.82 ea.  \$0.67 ea. /box of 1000
	B11370-80-XX Single Wall Bracket	\$124.87 ea.		52502-25 Overlap R 52504-25 Underlap L 59 black + 10% Standard Multi-Functional Master Use stiffener w/ exposed baton or hooks w/ hidden baton	\$8.80 ea.  \$7.34 ea. /box of 100
	B11873-50-XX Ceiling Bracket/ Invisible Wall Bracket	\$110.40 ea.		52502-25A Overlap R 52504-25A Underlap L 59A black + 10% Standard Multi-Functional Master w/ snaps	\$10.66 ea.  \$8.89 ea. /box of 100
	B11873-80-XX Extended Wall/ Ceiling Bracket	\$115.01 ea.		52411-25A Butt R 52412-25A Butt L 59A black, 90A grey Wheeled Butt Master w/snap adaptor Designed for hidden baton	\$37.74 ea.  \$31.44 ea. /box of 50 Colors other than white +10%
	B11870-40-XX 1 1/2" B11870-80-XX 3" Bracket Extensions for B11873-50-XX and B11873-80-XX	\$45.29 ea. \$48.41 ea.		B8809-23-00 Overlap R B8809-24-00 Underlap L 59 black + 10% Plastic Snap Master	\$15.46 ea.  \$12.86 ea. /box of 25
	B11873-15-XX Ceiling Bracket 5/8" Extension	\$68.78 ea.		V799-2-00 End Stop	\$1.07 ea.  \$0.88 ea. /box of 100
	B11592-00 Flush Ceiling Bracket	\$21.56 ea.			

 **BREAK PACK PRICING**  - Prices with this designation indicate a 20% up charge for broken pack quantities.



METAL TRAVERSING STUTT GART OVAL RAIL

Fiberglass batons in 36", 48", 60", 72", 84" and 96" lengths and these colors. See all batons page 43.



DECORATIVE WOOD Collections

VALENCIA 1 3/4"
Pole Sets



SEVILLE 1 3/8"
Pole Sets





Our wood drapery poles and accessories are made from only the finest solid woods such as ayous and ash. The richness of these woods and lovely finishes applied will add warmth and timeless beauty to any room.

CORDOBA 2"

Pole Sets, Traversing & Motorized



**MOTOR
CONTROL**
P. 109-110

GRANADA 2 3/4"

Pole Sets, Traversing & Motorized



**MOTOR
CONTROL**
P. 109-110

WOOD

1 3/4" VALENCIA POLE SETS | 1 3/8" SEVILLE POLE SETS | 2" CORDOBA POLE SETS | 2 3/4" GRANADA POLE SETS | TRAVERSING WOOD

WOOD POLES SETS VALENCIA



VALENCIA COLLECTION

1 3/4" Valencia wood pole sets made from highly grained, strong ash wood. Recommended weight is 4 lbs./ft. depending on application.



Scan for more information on FOREST VALENCIA POLE SETS

VALENCIA COLLECTION FINISHES XX = finish color

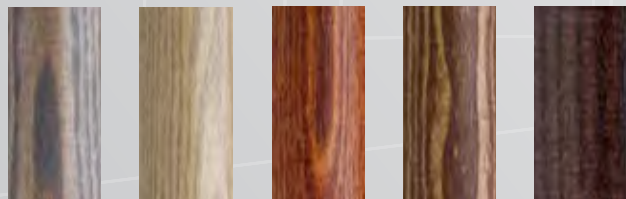

- 80
Driftwood
- 81
Weathered
Oak
- 82
Redwood
- 83
Tiger Oak
- 84
Espresso

VALENCIA COLLECTION POLE, BRACKET & RING



1045SWO-XX
1 3/4" Smooth Wood Pole
Stock Length: 8'
\$45.65/ft.



1245WBR-XX
Valencia Wall Bracket
\$48.58 ea.



1345WRI-XX
Valencia Wood Ring
\$3.40 ea.

WOOD

1 3/4" VALENCIA POLE SETS | 1 3/8" SEVILLE POLE SETS | 2" CORDOBA POLE SETS | 2 3/4" GRANADA POLE SETS | TRAVERSING WOOD

VALENCIA COLLECTION (CONTINUED)

Ash wood from France gives this collection a beautifully grained appearance.



80 Driftwood Smooth Pole with Castell Finial



81 Weathered Oak Smooth Pole with Granada Finial



82 Redwood Smooth Pole with Ringed Ball Finial



83 Tiger Oak Smooth Pole with Smooth Ball Finial



84 Espresso Smooth Pole with End Cap Finial

VALENCIA COLLECTION FINIALS



1145WEN-XX
End Cap Finial
\$13.59 ea.



1145SMO-XX
Smooth Ball Finial
\$29.56 ea.



1145RIN-XX
Ringed Ball Finial
\$29.56 ea.



1145GRA-XX
Granada Finial
\$23.29 ea.



1145CAS-XX
Castell Finial
\$24.49 ea.

WOOD

1 3/4" VALENCIA POLE SETS | **1 3/8" SEVILLE POLE SETS** | 2" CORDOBA POLE SETS | 2 3/4" GRANADA POLE SETS | TRAVERSING WOOD

WOOD POLE SETS SEVILLE



SEVILLE COLLECTION

1 3/8" Wood pole sets made from strong Ayous wood.
Recommended weight is 4 lbs./ft. depending on application.



Scan for more information on
FOREST SEVILLE POLE SETS

SEVILLE COLLECTION FINISHES XX = finish color

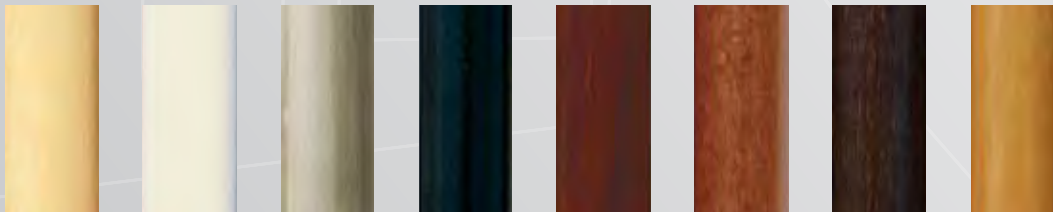

00 Unfinished 25 White 58 Stone 59 Black 70 Hazel 71 Honey 72 Walnut 73 Natural

SEVILLE COLLECTION POLE & BRACKETS



1035SWO-XX
1 3/8" Smooth Wood Pole
Stock Length: 13'
\$9.54/ft.

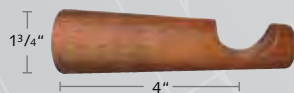

1235CYL-XX
Cylinder Bracket
\$17.86 ea.



1235CLA-XX
Classic Open Bracket
\$21.24 ea.

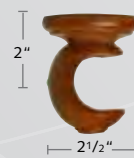

1235CEI-XX
Ceiling Bracket
\$17.94 ea.

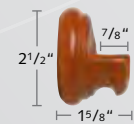

1235IMB-XX
Inside Mount Bracket
\$13.51 ea.

WOOD

1 3/4" VALENCIA POLE SETS | 1 3/8" SEVILLE POLE SETS | 2" CORDOBA POLE SETS | 2 3/4" GRANADA POLE SETS | TRAVERSING WOOD

SEVILLE COLLECTION (CONTINUED)

59 Black Pole with End Cap Finial



70 Hazel Pole with Bola Finial



25 White Pole with Country Finial



SEVILLE COLLECTION FINIALS, RINGS, HOLDBACKS & BATONS

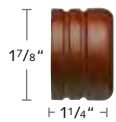

1135WEN-XX
End Cap Finial
\$8.54 ea.

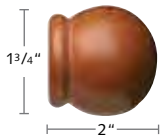

1135BOL-XX
Bola Finial
\$12.05 ea.

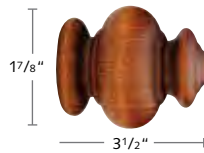

1135ODI-XX
Odiseia Finial
\$29.70 ea.

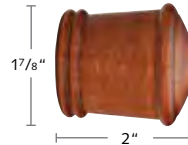

1135COR-XX
Corona Finial
\$15.11 ea.

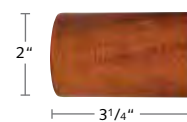

1135COU-XX
Country Finial
\$31.82 ea.

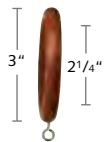

1335WRI-XX
1 3/8" Wood Ring
w/ Eyelet
\$2.95 ea.

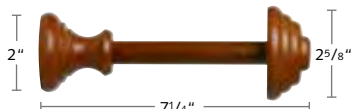

16WHOLD-XX
Wood Holdback
\$23.39 ea.



1504-00
Wood Screw
Connector
\$1.06 ea.



19WWAND-XX
40" Wood Baton
\$24.47 ea. unfinished
\$29.39 ea. finished

See all batons p. 43



19CWAND-XX
40" Modern Wood Baton
\$24.47 ea. unfinished
\$29.39 ea. finished

See all batons p. 43

WOOD

1 3/4" VALENCIA POLE SETS | 1 3/8" SEVILLE POLE SETS | **2" CORDOBA POLE SETS** | 2 3/4" GRANADA POLE SETS | TRAVERSING WOOD

WOOD POLE SETS CORDOBA



CORDOBA COLLECTION

2" Wood pole sets made from strong Ayous wood.
Recommended weight is 4 lbs./ft. depending on application.



MOTOR CONTROL
P. 109-110



Scan for more information on
FOREST CORDOBA POLE SETS

CORDOBA COLLECTION FINISHES XX = finish color Not all components are stocked in Antiqued finishes. Please call for availability.

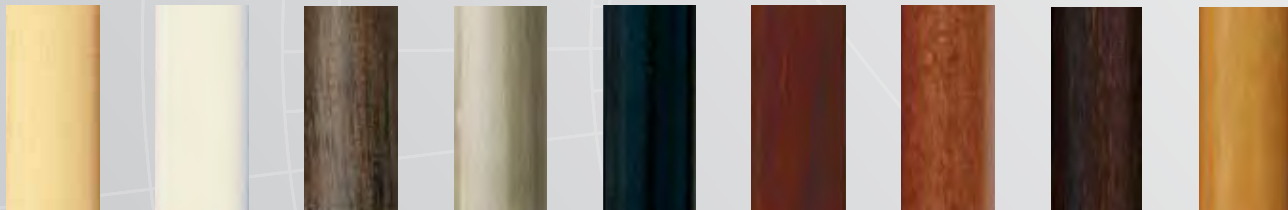

00 Unfinished	25 White	45 Leather Antiqued smooth poles only	58 Stone smooth poles only	59 Black	70 Hazel	71 Honey	72 Walnut	73 Natural
------------------	-------------	---	-------------------------------------	-------------	-------------	-------------	--------------	---------------

CORDOBA COLLECTION POLES & BRACKETS



1051SWO-XX
2" Smooth
Stock Length: 14'
\$21.36/ft. unfinished
\$24.20/ft. finished
\$36.26/ft. antiqued

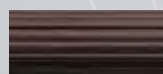

1051RWO-XX
2" Reeded
Stock Length: 14'
\$23.70/ft. unfinished
\$30.86/ft. finished
Not available in 45, 58



1251WBR-XX
Wood Bracket
\$39.34 ea. unfinished
\$48.58 ea. finished
\$71.11 ea. antiqued



1251EUR-XX
Euro Wood Bracket
\$25.14 ea. unfinished
\$32.81 ea. finished
\$50.45 ea. antiqued



1251WIM-XX
Open Inside Mount
Bracket
\$30.10 ea. unfinished
\$37.13 ea. finished
\$53.67 ea. antiqued

CORDOBA COLLECTION (CONTINUED)

71 Honey Smooth Pole with Zenith Finial



58 Stone Smooth Pole with Ringed Ball Finial



72 Walnut Reeded Pole with Odiseia Finial



CORDOBA COLLECTION FINIALS, RING, HOLDBACKS & BATONS



1151WEN-XX
End Cap Finial
\$13.98 ea. unfinished
\$17.47 ea. finished
\$23.07 ea. antiqued

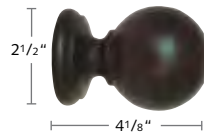

1151SMO-XX
Smooth Ball Finial
\$35.67 ea. unfinished
\$46.93 ea. finished
Not available in antiqued finishes



1151RIN-XX
Ringed Ball Finial
\$37.14 ea. unfinished
\$47.21 ea. finished
\$67.36 ea. antiqued

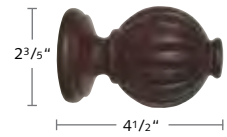

1151FLU-XX
Fluted Ball Finial
\$53.54 ea. unfinished
\$65.93 ea. finished
Not available in antiqued finishes

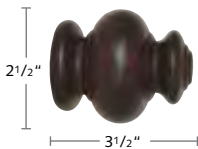

1151ODI-XX
Odiseia Finial
\$37.85 ea. unfinished
\$56.19 ea. finished
Not available in antiqued finishes

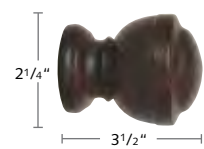

1151CAL-XX
Calice Finial
\$39.39 ea. unfinished
\$57.63 ea. finished
Not available in antiqued finishes



1151ZEN-XX
Zenith Finial
\$44.50 ea. unfinished
\$66.07 ea. finished
Not available in antiqued finishes

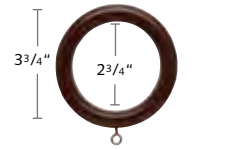

1351WRI-XX
2" Wood Ring w/ Eyelet
\$5.09 ea. unfinished
\$6.86 ea. finished
\$11.25 ea. antiqued

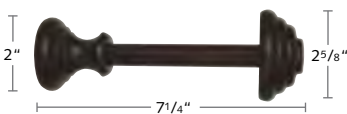

16WHOLD-XX
Wood Holdback
\$23.39 ea.



1504-00
Wood Screw Connector
\$1.06 ea.



19WWAND-XX
40" Wood Baton
\$24.47 ea. unfinished
\$29.39 ea. finished
\$54.72 ea. antiqued

See all batons p. 43



19CWAND-XX
40" Modern Wood Baton
\$24.47 ea. unfinished
\$29.39 ea. finished
\$54.72 ea. antiqued

See all batons p. 43

WOOD

1 3/4" VALENCIA POLE SETS | 1 3/8" SEVILLE POLE SETS | 2" CORDOBA POLE SETS | **2 3/4" GRANADA POLE SETS** | TRAVERSING WOOD

WOOD POLE SETS GRANADA



GRANADA COLLECTION

2 3/4" Wood pole sets made from strong Ayous wood.
Recommended weight is 4 lbs./ft. depending on application.



Scan for more information on
FOREST GRANADA POLE SETS



**MOTOR
CONTROL**
P. 109-110

GRANADA COLLECTION FINISH XX = finish color



00
Unfinished

GRANADA COLLECTION POLES & BRACKETS



1072SWO-00
2 3/4" Smooth
Stock Length: 13'
\$37.20/ft.

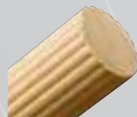

1072RWO-00
2 3/4" Reeded
Stock Length: 13'
\$39.17/ft.

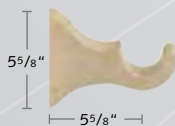

1272WBR-00
Wood Bracket
\$42.62 ea.

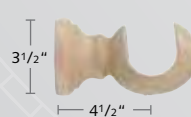

1272EUR-00
Euro Wood Bracket
\$50.77 ea.



1272WIM-00
Open Inside Mount Bracket
\$47.98 ea.

WOOD

1 3/4" VALENCIA POLE SETS | 1 3/8" SEVILLE POLE SETS | 2" CORDOBA POLE SETS | **2 3/4" GRANADA POLE SETS** | TRAVERSING WOOD

GRANADA COLLECTION (CONTINUED)



The Granada Collection is stocked unfinished. Call sales for pricing on your custom finish request.

GRANADA COLLECTION FINIALS, RING, HOLDBACKS & BATONS



1172WEN-00
End Cap Finial
\$17.16 ea.

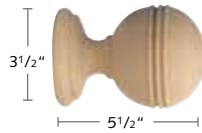

1172RIN-00
Ringed Ball Finial
\$58.97 ea.

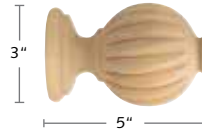

1172FLU-00
Fluted Ball Finial
\$76.82 ea.

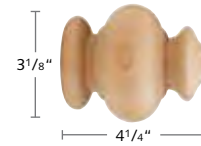

1172ODI-00
Odiseia Finial
\$56.38 ea.



1172TRA-00
Traditional Finial
\$78.75 ea.



1172ZEN-00
Zenith Finial
\$66.53 ea.

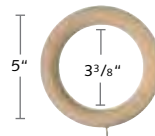

1372WRI-00
2 3/4" Wood Ring w/ Eyelet
\$20.04 ea.



16WHOLD-00
Wood Holdback
\$23.39 ea.



19WWAND-00
40" Wood Baton
\$24.47 ea.

See all batons p. 43



19CWAND-00
40" Modern Wood Baton
\$24.47 ea.

See all batons p. 43

WOOD

1 3/4" VALENCIA POLE SETS | 1 3/8" SEVILLE POLE SETS | 2" CORDOBA POLE SETS | 2 3/4" GRANADA POLE SETS | **TRAVERSING WOOD**

WOOD TRAVERSING SYSTEMS



Scan for more information on FOREST WOOD TRAVERSING

WOOD TRAVERSING

- 2" & 2 3/4" heavy duty hand, baton or cord draw traversing system for one- or two-way pinch pleat or ripplefold drapery.
- Maximum weight is 4 lbs per foot depending on application.

ASSEMBLED PRICING

Includes wood pole fascia, assembled track, wall brackets (bracket cover optional and available for purchase separately), customer's choice of finials on pages 64 & 66, c-ring where specified, and 36" white fiberglass baton (see all batons p. 41). Indicate pinch pleat or ripplefold when ordering. Freight is additional.



72 Walnut wood fascia over brown CS Track. Carriers are also available in colors.



MOTOR CONTROL
P. 109-110

WOOD TRAVERSING	TRAVERSING first 4 feet	TRAVERSING ea. add'l ft.	C-RING first 4 feet	C-RING ea. add'l ft.
2" Cordoba Single Unfinished	\$471.67	\$38.05	\$686.16	\$67.55
2" Cordoba Single Finished	\$557.71	\$46.57	\$832.78	\$85.24
2" Cordoba Double Unfinished	\$530.61	\$51.50	\$898.76	\$80.97
2" Cordoba Double Finished	\$603.94	\$59.99	\$1,048.25	\$98.67
2 3/4" Granada Single Unfinished	\$542.42	\$47.49	n/a	n/a
2 3/4" Granada Double Unfinished	\$610.20	\$60.40	n/a	n/a

CORDOBA COLLECTION FINISHES

XX = finish color Not all components are stocked in Antiqued finishes. Please call for availability.



00 Unfinished



25 White

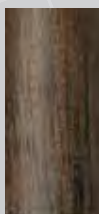

45 Leather Antiqued smooth poles only



58 Stone smooth poles only

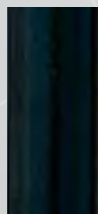

59 Black



70 Hazel



71 Honey

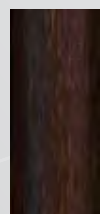

72 Walnut



73 Natural

WOOD

1 3/4" VALENCIA POLE SETS | 1 3/8" SEVILLE POLE SETS | 2" CORDOBA POLE SETS | 2 3/4" GRANADA POLE SETS | **TRAVERSING WOOD**

TRAVERSING WOOD POLES



1051RSW-XX
2" CORDOBA
Routed Smooth
Stock Length: 14'

1072RSW-00
2 3/4" GRANADA
Routed Smooth
Stock Length: 13'
Unfinished only



1051RRW-XX
2" CORDOBA
Routed Reeded
Stock Length: 14'

1072RRW-00
2 3/4" GRANADA
Routed Reeded
Stock Length: 13'
Unfinished only

TRAVERSING WOOD TRACKS

Use CS Track in white, black, brown or silver with color coordinating components, or use cord draw CCS Track in white, brown or silver with color coordinating components. Use with pinch pleat or ripplefold draperies. See all carrier and master options on pages 5-6 for CS and page 8 for CCS.

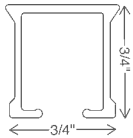
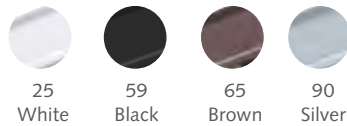

CS® CONTRACT SYSTEM
Aluminum extrusion, powder coated and lubricated.
Available in 25 white, 59 black, 65 brown and 90 silver.

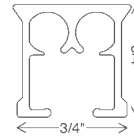
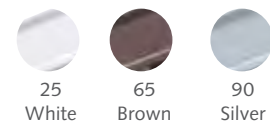

CCS® CONTRACT CORD SYSTEM
Aluminum extrusion, white, powder coated, lubricated. Available in 25 white, 65 brown and 90 silver. All corded systems include child safety tension device.

TRAVERSING WOOD BRACKETS



3280-25
59 black, 65 brown, 90 grey
3" Single Wall Bracket heavy duty
projection 2 1/2"
\$14.58 ea. \$12.15 ea./box of 20

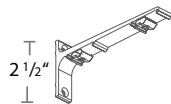

3281-25
59 black, 65 brown
6" Double Wall Bracket heavy duty
projection 1 1/2", 5 1/2"
\$20.90 ea. \$17.37 ea./box of 15



32801-25
59 black, 90 grey + 10%
Wall Bracket Cover, optional
\$3.76 ea. \$3.13 ea./box of 50

OPTIONAL C-RINGS FOR 2" CORDOBA



1352WRI-XX
C-Ring
Choose white, black or brown carrier
\$11.05 ea.



52007-25
59 black, 65 brown + 10%
C-Ring Carrier
\$0.60 ea.

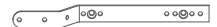

52405-65 Overlap R
52406-65 Underlap L
90 grey + 10%
C-Ring Master Carrier
\$8.10 ea.

BATON OPTIONS See all batons p. 43



19WWAND-XX
40" Wood Baton
\$24.47 ea. unfinished
\$29.39 ea. finished
\$54.72 ea. antiqued



19CWAND-XX
40" Modern Wood Baton
\$24.47 ea. unfinished
\$29.39 ea. finished
\$54.72 ea. antiqued

Fiberglass batons come in 36", 48", 60", 72", 84" and 96" lengths and colors below. See all batons p. 43





MOTORIZED Collections

FMS[®]

Heavy Duty Track System



RMS

Recessed Motorized System



HANOVER

Contemporary Designer Profile



DRESDEN

1 1/8" Decorative Metal





Our wide range of control options make finding a fit for your room easy; controlling the drapery by hand, remote or by building automation system. When controlling motorized drapery with your smart phone or tablet, you can create and schedule customized room schedules that allow your drapes to operate on their own throughout the day.

DSXL LED

Designer Track with LED Lighting

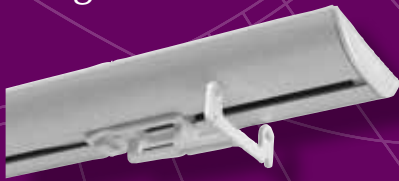

THE WORLD BEHIND YOUR DRAPERIES

DEVENTER MRS®

1 1/8" Decorative Metal



CORDOBA/GRANADA

2" & 2 3/4" Decorative Wood





DRAPERY MOTORIZATION

SHUTTLE MOTOR SPECIFICATIONS | CONTROLS ROADMAP | FMS | RMS | DSXL LED | HANOVER | DRESDEN | DEVENTER MRS | WOOD

DARPERY MOTORIZATION SHUTTLE MOTOR SPECIFICATIONS



-  Hey Google
-  Hey Siri
-  Hey Alexa

SHUTTLE® HD (M)

SHUTTLE® ECO (S)



SPECIFICATIONS

FEATURES

VOLTAGE SHUTTLE RECEIVER	24V DC Internal, optional	24V DC Internal
POWER SUPPLY	External, 100-240V AC - 1.5A, 50-60Hz; Output 24V DC - 2.7A	External, 100-240V AC - 0.8A, 50-60Hz; Output 24V DC - 2.5A
MAX POWER	65W	40W
TORQUE	1.5 Nm	1.0 Nm
TRAVEL SPEED	5.5" per second standard 7" per second maximum	5.5" per second standard 7" per second maximum
NOISE LEVEL	< 40 dB(A)	< 40 dB(A)
MAXIMUM WEIGHT	160 lbs per motor 120 lbs per motor - curved track	100 lbs per motor 90 lbs per motor - curved track
DIMENSIONS	2.76" x 1.97" x 9.5"	2.76" x 1.97" x 7.5"
CERTIFICATIONS/MARKINGS	CE/FCC/DOE	CE/FCC/DOE
COLOR OPTIONS	White / Black	White
TOUCH CONTROL TECHNOLOGY	✓	✓
INTEGRATED EMERGENCY CONTROL	✓	✓
RF COMMUNICATION STANDARD	✓	✓
Z-WAVE COMMUNICATION	-	-
AUTOMATION SYSTEM COMPATIBLE	✓ using RS485 & dry contacts	✓ using RS485 & dry contacts
WI-FI COMPATIBLE	✓	✓
WORKS WITH DS-XL LED DIMMER	✓	✓
WORKS WITH WIRELESS CONNECTOR	✓	✓
CAN BE USED WITH CURVED TRACK	✓	✓
PLUG & PLAY	✓	✓
WARRANTY	10 Years	10 Years

DRAPERY MOTORIZATION

SHUTTLE MOTOR SPECIFICATIONS | CONTROLS ROADMAP | FMS | RMS | DSXL LED | HANOVER | DRESDEN | DEVENTER MRS | WOOD



SMART HOME
READY



APP
CONTROL



WIRELESS
REMOTE



TOUCH
CONTROL

SHUTTLE® iOn



SPECIFICATIONS

VOLTAGE SHUTTLE	14.8V DC
RECEIVER	Internal
BATTERY	Lithium iOn battery + charger (3-4 months between charges)
MAX POWER	30W
TORQUE	1.0 Nm
TRAVEL SPEED	5.5" per second standard
NOISE LEVEL	< 40 dB(A)
MAXIMUM WEIGHT	55 lbs per motor 40 lbs per motor - curved track
DIMENSIONS	2" x 3" x 12.25"
CERTIFICATIONS/MARKINGS	CE/FCC/DOE
COLOR OPTIONS	White

FEATURES

TOUCH CONTROL TECHNOLOGY	✓
INTEGRATED EMERGENCY CONTROL	✓
RF COMMUNICATION STANDARD	✓
Z-WAVE COMMUNICATION	-
AUTOMATION SYSTEM COMPATIBLE	✓ using RS485 & dry contacts
WI-FI COMPATIBLE	✓
WORKS WITH DS-XL LED DIMMER	✓
WORKS WITH WIRELESS CONNECTOR	✓
CAN BE USED WITH CURVED TRACK	✓
PLUG & PLAY	✓
WARRANTY	10 Years on motor 2 years on battery pack

Our wide variety of control options make finding a fit for your windows easy – controlling the drapes by hand, wall switch, remote or even by home automation system. Controlling the motorized system with your smart phone or tablet, you can create and schedule customized room scenes that allow your drapes to operate on their own throughout the day no matter where you are.



TOUCH CONTROL

Open or close your drapes with a gentle tug.



FOREST WALL SWITCH

2-channel wall switch, wireless. Can be used with all Forest Shuttle motors.



FOREST DIAMOND SENSE REMOTE

15-channel remote controls up to 15 motors individually and together, with a timer or manually. Range up to 98 feet. Wall mounted holder included.



BOND BRIDGE PRO

With the Bond Bridge Pro, easily pair your Forest remote and get app control for Forest motorized window coverings and other devices all in one place.

FOR ADDITIONAL CONTROL OPTIONS, SEE THE ROADMAP ON THE FOLLOWING PAGES.

DRAPERY MOTORIZATION

SHUTTLE MOTOR SPECIFICATIONS | **CONTROLS ROADMAP** | FMS | RMS | DSXL LED | HANOVER | DRESDEN | DEVENTER MRS | WOOD

HOW DO YOU WANT TO CONTROL YOUR DRAPERY?

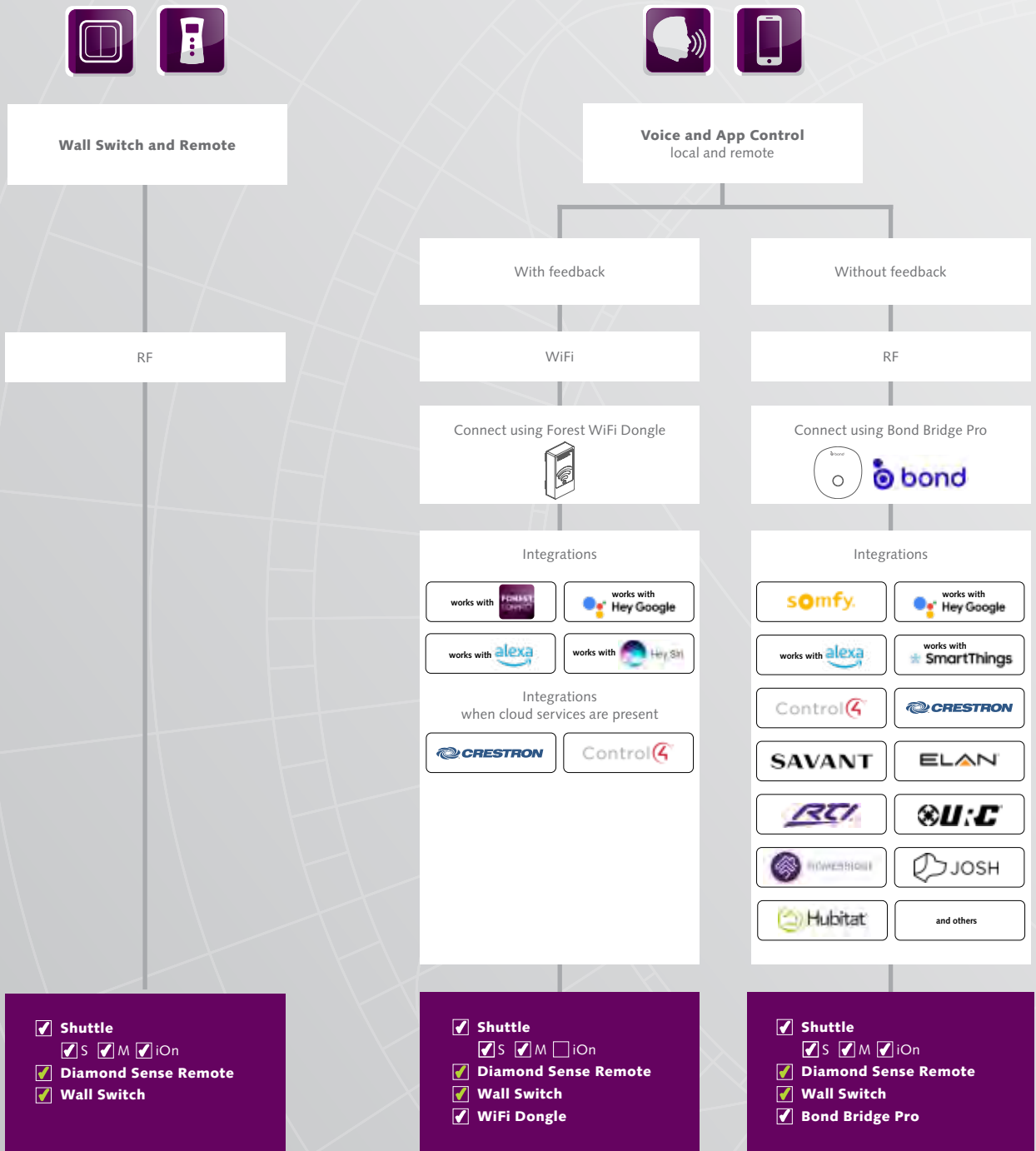

DRAPERY MOTORIZATION

SHUTTLE MOTOR SPECIFICATIONS | **CONTROLS ROADMAP** | FMS | RMS | DSXL LED | HANOVER | DRESDEN | DEVENTER MRS | WOOD



Wired Building Automation System

we advise you work with an installation specialist

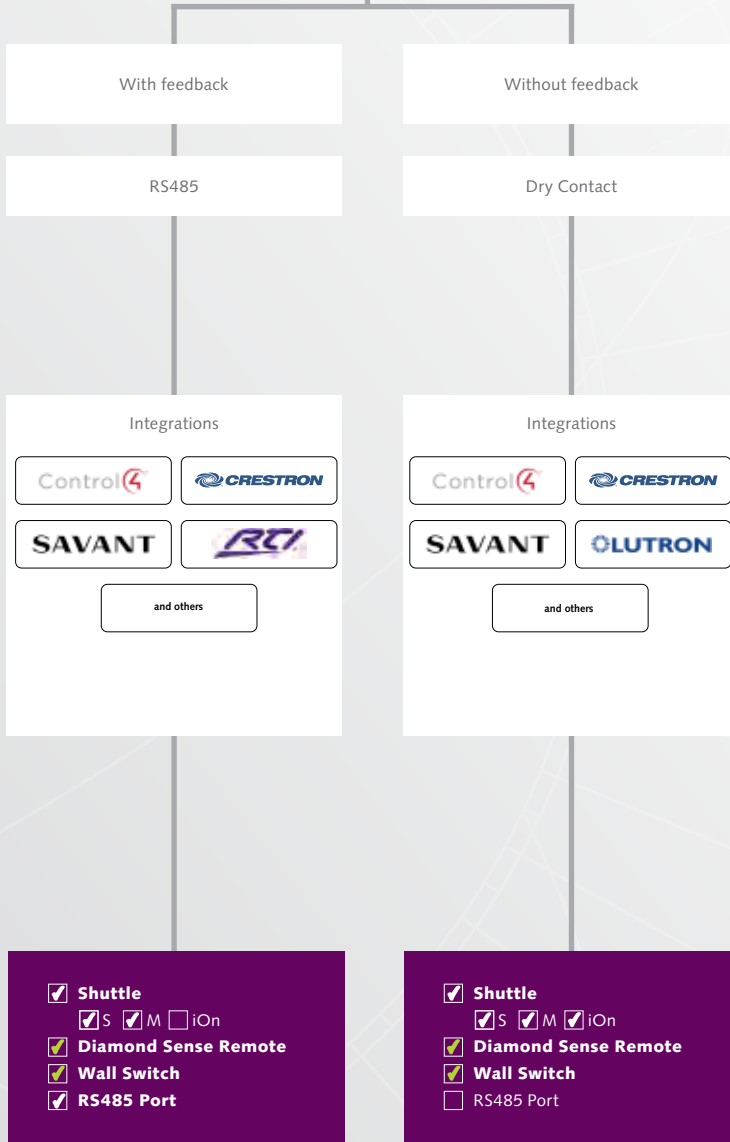

DRAPERY MOTORIZATION

SHUTTLE MOTOR SPECIFICATIONS | CONTROLS ROADMAP | **FMS** | RMS | DSXL LED | HANOVER | DRESDEN | DEVENTER MRS | WOOD



Scan for more information on the FMS Motorized Track System



FMS® FOREST MOTORIZED SYSTEM

- The original Forest motorized track, aluminum extrusion, white, powder coated and lubricated with a patented process. Ultra-quiet and smooth operation for contract or residential applications.
- Track can be bent or curved. An actual size template is required. See pages 41-42 for more information.
- Maximum weight is 6 lbs/ft.
- Motorize with any Forest Shuttle. See all motor specifications on pages 91-92. All Forest Shuttle motors include a 10 year warranty.
- Control drapes with a gentle tug, wall switch remote, any home automation system or by smart phone app. See control options pages 93-94.





ASSEMBLED PRICING



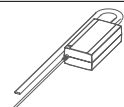

Includes track, masters, pinchpleat or ripplefold carriers, brackets, motor, power supply, and Diamond Sense remote or wall switch. Add 10% for black. Freight is additional.

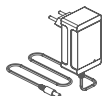
FMS MOTORIZED TRACK	first 4 feet	ea. add'l foot
Shuttle HD (M) white	\$2,369.88	\$36.99
Shuttle HD (M) black	\$2,606.87	\$40.69
Shuttle Eco (S)	\$2,156.82	\$36.99
Shuttle iOn	\$2,362.52	\$36.99

See all motor specifications on pages 91-92.

DRAPERY MOTORIZATION FMS TRACK

FMS	COMPONENT	PRICE
• 	52925-25 Shuttle HD (M) 52925-59 Shuttle HD (M) black 52939-25 Shuttle Eco (S) See motor specs on pages 91-92	\$1,338.39 ea. \$1,472.24 ea. \$1,062.81 ea. 1/box
• 	52928-25 Power Cord, 7' 6" 52934-25 Power Cord, 16' includes 24 volt power supply	\$170.18 ea. 1/box
• 	52926-25 Shuttle iOn Includes battery pack. Order charging cable below separately, 52924-59 . See motor specs on pages 91-92	\$1,331.03 ea. 1/box
• 	52924-59 Battery Charger Charges battery included with Shuttle iOn motor above, 52926-25 .	\$81.93 ea. 1/box
• 	52949-25 Battery Pack Additional battery pack for Shuttle iOn motor	\$506.17 ea. 1/box

FMS	COMPONENT	PRICE
• 	52933-25 white 59 black +10% Forest Wall Switch 2 channel	\$213.73 ea. 1/box
• 	52931-25D white 59D black +10% Diamond Sense Remote RF, 15 channel w/ holder, range 98'	\$434.19 ea. 1/box
• 	52948-25 59 black +10% Wi-Fi Dongle For voice and app control over wi-fi. Provides feedback (bi-directional). Use with Shuttles HD and Eco.	\$265.36 ea. 1/box
• 	52955-25 Bond Bridge Pro For voice and app control over RF. Easily pair using the Forest remote. Controls all of your devices in one hub.	\$379.00 ea. 1/box no discounts taken on this item

DRAPERY MOTORIZATION

SHUTTLE MOTOR SPECIFICATIONS | CONTROLS ROADMAP | **FMS** | RMS | DSXL LED | HANOVER | DRESDEN | DEVENTER MRS | WOOD

FMS	COMPONENT	PRICE	FMS	COMPONENT	PRICE
●	 <p>51319-25 white 59 black +10% FMS Track 19' x 10 tracks per bundle bundle = 190'</p>	\$7.00/ft.	●	 <p>52009-25 Ball Bearing Carrier for motorization</p>	\$1.84 ea.  \$1.51 ea. /box of 250
●	 <p>3906-25 59 black +10% Track Connector and Key 3904-00</p>	\$20.37 ea.	●	 <p>52508-25 Overlap Right 52509-25 Underlap Left 59 black +10% Belt Master Carrier</p>	\$15.51 ea.  \$12.95 ea. /box of 100
●	 <p>3003-25 59 black +10% HD Klick Ceiling Bracket</p>	\$2.65 ea.  \$2.19 ea. /box of 100	●	 <p>52508-25A Overlap Right 52509-25A Underlap Left 59A black +10% Belt Master Carrier with snaps</p>	\$18.39 ea.  \$15.33 ea. /box of 100
●	 <p>30031-25 59 black +10% Ceiling Bracket Cover</p>	\$1.10 ea.  \$0.92 ea. /box of 100	●	 <p>52410-25 Butt Right 52409-25 Butt Left 59 black +10% Butt Master Carrier with snaps</p>	\$21.38 ea.  \$17.80 ea. /box of 50
●	 <p>53202-25 59 black +10% 3" Klick Single Wall Bracket with wide base adjusts 3" - 4 1/2"</p>	\$6.34 ea.  \$5.28 ea. /box of 100	●	 <p>2552-25 6" Extension Arm for master Use w/ two one-way draw</p>	\$14.42 ea.  \$12.03 ea. /box of 50
●	 <p>53206-25 59 black +10% 6" Klick Double Wall Bracket with wide base adjusts 2 1/2" - 4" and 6" - 7 1/2"</p>	\$11.16 ea.  \$9.30 ea. /box of 50	●	 <p>9012-25 Transport Belt Kevlar reinforced</p>	\$14.02/ft.  \$11.66/ft. /roll 328 ft.
●	 <p>Two Piece Connected Snap Carrier w/ Square Base, in plastic sleeve. Use 1 1/4" snap tape 2114-25, 59 black 60% fullness, 2 5/8" OC 2111-25, 65 brown, 90 grey 80% fullness, 2 3/8" OC 2112-25, 59 black 100% fullness, 2 1/8" OC 2115-25, 59 black 120% fullness, 1 7/8" OC</p>	\$1.47 ea.  \$1.23 ea. /roll of 500 Colors other than white +10%	●	 <p>52512-25 white 59 black +10% Transport Belt Connector</p>	\$14.51 ea.  \$12.12 ea. /box of 50
●	 <p>52008-25 59 black +10% Slim Line Klick Carrier Draperies hang to conceal track</p>	\$1.31 ea.  \$1.08 ea. /box of 250	●	 <p>52903-25 59 black +10% Motor Pulley Connects motor to track</p>	\$74.45 ea. 1/box
			●	 <p>52910-25 59 black +10% Return Pulley</p>	\$42.80 ea. 1/box
			●	 <p>52912-25 Open Return Pulley</p>	\$40.76 ea. 1/box

 **BREAK PACK PRICING**  - Prices with this designation indicate a 20% up charge for broken pack quantities.

DRAPERY MOTORIZATION

SHUTTLE MOTOR SPECIFICATIONS | CONTROLS ROADMAP | FMS | **RMS** | DSXL LED | HANOVER | DRESDEN | DEVENTER MRS | WOOD

DRAPERY MOTORIZATION RECESSED TRACK



Scan for more information on the FOREST RMS Recessed Motorized System



RMS RECESSED MOTORIZED SYSTEM





- Heavy duty aluminum extrusion, white, powder coated and lubricated with a patented process. Ultra-quiet and smooth operation for contract or residential applications.
- Maximum weight is 8 lbs/ft.
- Motorize with any Forest Shuttle. See all motor specifications on pages 91-92. All Forest Shuttle motors include a 10 year warranty.
- Control drapes with a gentle tug, wall switch remote, any home automation system or by smart phone app. See control options pages 93-94.



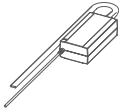

ASSEMBLED PRICING

Includes track, masters, pinchpleat or ripplefold carriers, recess profile, fixing strip, wedge, motor, pulley, cover plate, power supply, and Diamond Sense remote or Diamond Sense wall switch. Freight is additional.

RMS SYSTEM	first 4 feet	ea. add'l foot
Shuttle HD (M) white	\$2,481.31	\$119.76
Shuttle HD (M) black	\$2,729.44	\$131.74
Shuttle Eco (S)	\$2,489.79	\$119.76
Shuttle iOn	\$2,654.40	\$119.76











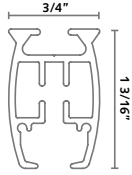
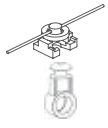

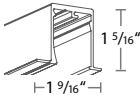
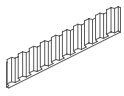
See all motor specifications on pages 91-92.

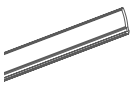
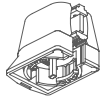
RMS	COMPONENT	PRICE
• 	52925-25 Shuttle HD (M) 52925-59 Shuttle HD (M) black 52939-25 Shuttle Eco (S) See motor specs on pages 91-92	\$1,338.39 ea. \$1,472.24 ea. \$1,062.81 ea. 1/box
• 	52928-25 Power Cord, 7' 6" 52934-25 Power Cord, 16' includes 24 volt power supply	\$170.18 ea. 1/box
• 	52926-25 Shuttle iOn Includes battery pack. Order charging cable below separately, 52924-59 . See motor specs on pages 91-92	\$1,331.03 ea. 1/box
• 	52924-59 Battery Charger Charges battery included with Shuttle iOn motor above, 52926-25 .	\$81.93 ea. 1/box
• 	52949-25 Battery Pack Additional battery pack for Shuttle iOn motor	\$506.17 ea. 1/box

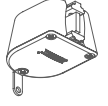
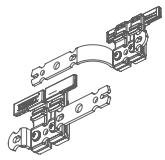
RMS	COMPONENT	PRICE
• 	52933-25 white 59 black +10% Forest Wall Switch 2 channel	\$213.73 ea. 1/box
• 	52931-25D white 59D black +10% Diamond Sense Remote RF, 15 channel w/ holder, range 98'	\$434.19 ea. 1/box
• 	52948-25 59 black +10% Wi-Fi Dongle For voice and app control over wi-fi. Provides feedback (bi-directional). Use with Shuttles HD and Eco.	\$265.36 ea. 1/box
• 	52955-25 Bond Bridge Pro For voice and app control over RF. Easily pair using the Forest remote. Controls all of your devices in one hub.	\$379.00 ea. 1/box no discounts taken on this item

DRAPERY MOTORIZATION

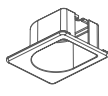
SHUTTLE MOTOR SPECIFICATIONS | CONTROLS ROADMAP | FMS | **RMS** | DSXL LED | HANOVER | DRESDEN | DEVENTER MRS | WOOD

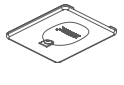
RMS	COMPONENT	PRICE	RMS	COMPONENT	PRICE
●	 <p>51623-25 RMS Track white 23' x 10 tracks/bundle bundle = 230'</p>	\$14.87/ft.	●	 <p>Two Piece Connected Snap Carrier w/ Square Base, in plastic sleeve. Use 1 1/4" snap tape 2114-25, 59 black 60% fullness, 2 5/8" OC 2111-25, 65 brown, 90 grey 80% fullness, 2 3/8" OC 2112-25, 59 black 100% fullness, 2 1/8" OC 2115-25, 59 black 120% fullness, 1 7/8" OC</p>	\$1.47 ea.  \$1.23 ea. /roll of 500 Colors other than white +10%
●	 <p>51723-25 Recess Profile, 23' Order same length as track</p>	\$19.65/ft.	●	 <p>9112-25 Transport Belt</p>	\$14.02/ft.  \$11.66/ft. /roll 328 ft.
●	 <p>51724-25 Recess Profile Fixing Strip, 23' Order 6" shorter than track</p>	\$4.13/ft.	●	 <p>53903-25 Motor Pulley Connects motor to track</p>	\$97.36 ea. 1/box
●	 <p>53914-25 Recess Profile Wedge Order 1 per track</p>	\$5.80 ea.  \$4.81 ea. /box of 10	●	 <p>53910-25 Return Pulley</p>	\$48.65 ea. 1/box
●	 <p>53908-25 Overlap Right 53909-25 Underlap Left FMS Plus Master Carrier</p>	\$46.81 ea.  \$39.01 ea. /box of 10	●	 <p>53911-25 Upside Down Pulley</p>	\$97.36 ea. 1/box
●	 <p>52008-25 Slim Line Klick Carrier Draperies hang to conceal track</p>	\$1.31 ea.  \$1.08 ea. /box of 250	●	 <p>53912-25 Cover Plate for Recess Motor and Return Pulley</p>	\$5.30 ea. 1/box
●	 <p>52009-25 Ball Bearing Carrier for motorization</p>	\$1.84 ea.  \$1.51 ea. /box of 250	●	 <p>53913-25 Cover Plate for Recess Motor, Upside Down Motor, and Return Pulley</p>	\$4.47 ea. 1/box

 **BREAK PACK PRICING**  - Prices with this designation indicate a 20% up charge for broken pack quantities.

DRAPERY MOTORIZATION

SHUTTLE MOTOR SPECIFICATIONS | CONTROLS ROADMAP | FMS | RMS | **DSXL LED** | HANOVER | DRESDEN | DEVENTER MRS | WOOD



Scan for more information on the FOREST DSXL Motorized System

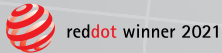

DSXL® LED MOTORIZED DESIGN SYSTEM + LED LIGHTING



- Elegantly shaped aluminum extrusion, white, powder coated and lubricated with a patented process. LED lighting lights up the backside of drapery or the track itself. Ultra-quiet and smooth operation for contract or residential applications.
- LED strips have low energy consumption, are eco-friendly, dimmable. Lifespan is 30,000 hours.
- Maximum weight is 3 lbs/ft.
- Motorize with any Forest Shuttle. See all motor specifications on pages 91-92. All Forest Shuttle motors include a 10 year warranty.
- Control drapes with a gentle tug, wall switch remote, any home automation system or by smart phone app. See control options pages 93-94.

ASSEMBLED PRICING

Includes track, masters, pinchpleat or ripplefold carriers, brackets, lighting components, motor, power supply, and Diamond Sense remote or wall switch. Freight is additional.

DSXL LED MOTORIZED	first 4 feet	ea. add'l foot
Shuttle HD (M) white	\$3,798.82	\$139.58
Shuttle Eco (S)	\$3,261.63	\$139.58

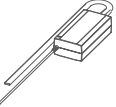



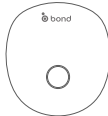





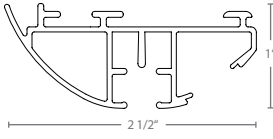
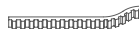





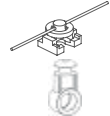

See all motor specifications on pages 91-92.

DSXL LED	COMPONENT	PRICE
• 	52925-25 Shuttle HD (M) 52925-59 Shuttle HD (M) black 52939-25 Shuttle Eco (S) See motor specs on pages 91-92	\$1,338.39 ea. \$1,472.24 ea. \$1,062.81 ea. 1/box
• 	52928-25 Power Cord, 7' 6" 52934-25 Power Cord, 16' includes 24 volt power supply	\$170.18 ea. 1/box
• 	52933-25 white 59 black +10% Diamond Sense Wall Switch 2 channel	\$213.73 ea. 1/box
• 	52931-25D white 59D black +10% Diamond Sense Remote RF, 15 channel w/ holder, range 98'	\$434.19 ea. 1/box

DSXL LED	COMPONENT	PRICE
• 	52948-25 59 black +10% Wi-Fi Dongle For voice and app control over wi-fi. Provides feedback (bi-directional). Use with Shuttles HD and Eco.	\$265.36 ea. 1/box
• 	52955-25 Bond Bridge Pro For voice and app control over RF. Easily pair using the Forest remote. Controls all of your devices in one hub.	\$379.00 ea. 1/box no discounts taken on this item

DRAPERY MOTORIZATION

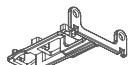
SHUTTLE MOTOR SPECIFICATIONS | CONTROLS ROADMAP | FMS | RMS | **DSXL LED** | HANOVER | DRESDEN | DEVENTER MRS | WOOD

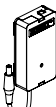
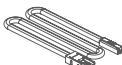
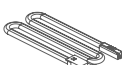
DSXL LED	COMPONENT	PRICE	DSXL LED	COMPONENT	PRICE
•	 <p>3219-25 DSXL LED Motorized Track white 19' x 10 tracks per bundle bundle = 190'</p>	\$21.62/ft.	•	 <p>9012-25 Transport Belt Kevlar reinforced</p>	\$14.02/ft.  \$11.66/ft. /roll 328 ft.
•	 <p>2302-25 DSXL Swivel Ceiling Bracket</p>	\$3.11 ea.  \$2.59 ea. /box of 200	•	 <p>52512-25 white Transport Belt Connector</p>	\$14.51 ea.  \$12.12 ea. /box of 50
•	 <p>2301-25 DSXL Wall Bracket w/ Swivel</p>	\$51.32 ea.  \$42.79 ea. /box of 5	•	 <p>3203-25 Motor Pulley Connects motor to track</p>	\$40.76 ea. 1/box
•	 <p>Two Piece Connected Snap Carrier w/ Square Base, in plastic sleeve. Use 1 1/4" snap tape 2114-25, 59 black 60% fullness, 2 5/8" OC 2111-25, 65 brown, 90 grey 80% fullness, 2 3/8" OC 2112-25, 59 black 100% fullness, 2 1/8" OC 2115-25, 59 black 120% fullness, 1 7/8" OC</p>	\$1.47 ea.  \$1.23 ea. /roll of 500 Colors other than white +10%	•	 <p>3000-00 LED Strip, 3000k/24v 30,000 hr lifespan, dimmable</p>	\$70.26 ea. /19' strip \$3.70/ft.
•	 <p>52008-25 Slim Line Klick Carrier Draperies hang to conceal track</p>	\$1.31 ea.  \$1.08 ea. /box of 250	•	 <p>3010-00 LED Strip, middle</p>	\$72.04 ea. /19' strip \$3.79/ft.
•	 <p>52009-25 Ball Bearing Carrier for motorization</p>	\$1.84 ea.  \$1.51 ea. /box of 250	•	 <p>3030-00 Mounting Device for LED Strip</p>	\$355.60 ea.
•	 <p>9040-25 FES Butt Master</p>	\$6.22 ea.  \$5.18 ea. /box of 25	•	 <p>3103-25 LED Dimmer Allows control of light strip with Diamond remote.</p>	\$287.39 ea. 1/box
			•	 <p>3100-00 with 6' 6" cord 3105-25 with 13" cord Cable for LED Strip 3045 Power Supply, 24 volt Dimmer accessory</p>	\$35.02 ea. \$28.47 ea. 1/box
			•	 <p>3106-25 Extension Cable for LED Strip 3045, 6' 6" Dimmer accessory</p>	\$31.63 ea. 1/box

 **BREAK PACK PRICING**  - Prices with this designation indicate a 20% up charge for broken pack quantities.

DRAPERY MOTORIZATION

SHUTTLE MOTOR SPECIFICATIONS | CONTROLS ROADMAP | FMS | RMS | DSXL LED | **HANOVER** | DRESDEN | DEVENTER MRS | WOOD



Scan for more information on the FOREST HANOVER Motorized System

HANOVER MOTORIZED SYSTEM

- A sleek stylish motorized profile best suited for light to medium weight draperies.
- Wall or ceiling mount. See bracket count below.
 - 0-5' = 2 brackets 11-15' = 4 brackets
 - 6-10' = 3 brackets 16-20' = 5 brackets
- Motorize with any Forest Shuttle. See all motor specifications on pages 91-92. All Forest Shuttle motors include a 10 year warranty.
- Control drapes with a gentle tug, wall switch, remote, any home automation system or by smart phone app. See control options pages 93-94.

ASSEMBLED PRICING

Includes rail, motor, power supply, motor pulley, return pulley, single wall brackets, carriers, masters, and Diamond remote or wall switch. Freight is additional.

HANOVER MOTORIZED	first 4 feet	ea. add'l foot
Shuttle HD (M) white	\$3,801.00	\$219.69
Shuttle HD (M) black	\$4,162.71	\$269.34
Shuttle Eco (S)	\$3,546.67	\$219.69
Shuttle iOn	\$3,705.37	\$219.69

AVAILABLE FINISHES XX = finish color

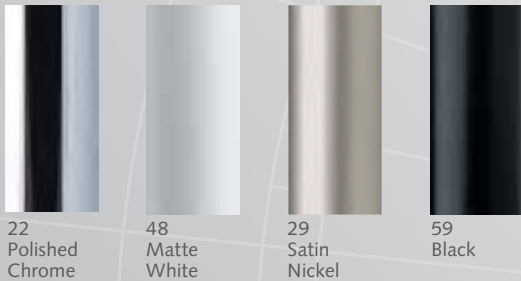



See all motor specifications on pages 91-92.

HANOVER	COMPONENT	PRICE
	52925-25 Shuttle HD (M) 52925-59 Shuttle HD (M) black 52939-25 Shuttle Eco (S) See motor specs on pages 91-92	\$1,338.39 ea. \$1,472.24 ea. \$1,062.81 ea. 1/box
	52928-25 Power Cord, 7' 6" 52934-25 Power Cord, 16' includes 24 volt power supply	\$170.18 ea. 1/box
	52926-25 Shuttle iOn Includes battery pack. Order charging cable below separately, 52924-59. See motor specs on pages 91-92	\$1,331.03 ea. 1/box
	52924-59 Battery Charger Charges battery included with Shuttle iOn motor above, 52926-25.	\$81.93 ea. 1/box
	52949-25 Battery Pack Additional battery pack for Shuttle iOn motor	\$506.17 ea. 1/box

HANOVER	COMPONENT	PRICE
	52933-25 white 59 black +10% Forest Wall Switch 2 channel	\$213.73 ea. 1/box
	52931-25D white 59D black +10% Diamond Sense Remote RF, 15 channel w/ holder, range 98'	\$434.19 ea. 1/box
	52948-25 59 black +10% Wi-Fi Dongle For voice and app control over wi-fi. Provides feedback (bi-directional). Use with Shuttles HD and Eco.	\$265.36 ea. 1/box
	52955-25 Bond Bridge Pro For voice and app control over RF. Easily pair using the Forest remote. Controls all of your devices in one hub.	\$379.00 ea. 1/box no discounts taken on this item

DRAPERY MOTORIZATION

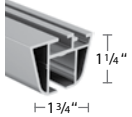
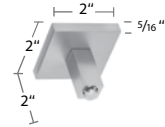
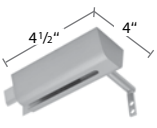
SHUTTLE MOTOR SPECIFICATIONS | CONTROLS ROADMAP | FMS | RMS | DSXL LED | **HANOVER** | DRESDEN | DEVENTER MRS | WOOD

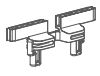
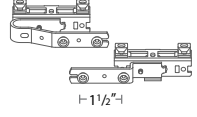
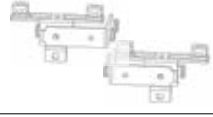
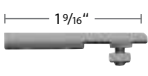
HANOVER	COMPONENT	PRICE	HANOVER	COMPONENT	PRICE
	B8223246-XX Hanover Profile 19' 7"	\$68.65/ft.		B11473-50-XX Ceiling Bracket 2" Projection	\$123.11 ea.
	B8221818-25/59 Hanover Rail	\$15.61/ft.		B11473-80-XX Ceiling Bracket 2 7/8" Projection	\$127.72 ea.
	B11679-L-46-XX Left Motor Pulley	\$886.73 ea.		B11473-15-XX Ceiling Bracket 5/8" Extension	\$73.02 ea.
	B11679-R-46-XX Right Motor Pulley	\$886.73 ea.		Two Piece Connected Snap Carrier w/ Square Base, in plastic sleeve. Use 1 1/4" snap tape 2114-25, 59 black 60% fullness, 2 5/8" OC 2111-25, 65 brown, 90 grey 80% fullness, 2 3/8" OC 2112-25, 59 black 100% fullness, 2 1/8" OC 2115-25, 59 black 120% fullness, 1 7/8" OC	\$1.47 ea. \$1.23 ea. /roll of 500 Colors other than white +10%
	B11683-L-46-XX Left End Pulley	\$491.16 ea.		52008-25 Slim Line Klick Carrier Allows drapery to hang and conceal track	\$1.31 ea. \$1.08 ea. /box of 250
	B11683-R-46-XX Right End Pulley	\$491.16 ea.		52009-25 Ball Bearing Carrier	\$1.84 ea. \$1.51 ea. /box of 250
	9012-25 Transport Belt Kevlar reinforced	\$14.02/ft. \$11.66/ft. /roll 328 ft.		52508-25 Overlap Right 52509-25 Underlap Left 59 black +10% Belt Master Carrier	\$15.51 ea. \$12.95 ea. /box of 100
	52512-25 white 59 black +10% Transport Belt Connector	\$14.51/ft. \$12.12/ft. /roll 328 ft.		52508-25A Overlap R 52509-25A Underlap L Belt Master Carrier with snaps	\$18.39 ea. \$15.33 ea. /box of 100
	B11260-130-XX Extended Wall Bracket P = 4 3/4"	\$217.17 ea.		52410-25 Butt Right 52409-25 Butt Left 59 black +10% Butt Master Carrier with snaps	\$21.38 ea. \$17.80 ea. /box of 50
	B11592-00 Flush Ceiling Bracket	\$21.56 ea.		2552-25 6" Extension Arm for master Use w/ two one-way draw	\$14.42 ea. \$12.03 ea. /box of 50

BREAK PACK PRICING - Prices with this designation indicate a 20% up charge for broken pack quantities.

DRAPERY MOTORIZATION

SHUTTLE MOTOR SPECIFICATIONS | CONTROLS ROADMAP | FMS | RMS | DSXL LED | HANOVER | **DRESDEN** | DEVENTER MRS | WOOD

DRAPERY MOTORIZATION DRESDEN



Scan for more information on FOREST DRESDEN MOTORIZED



DRESDEN MOTORIZED

- 1 1/8" motorized system best suited for light to medium weight draperies.
- Rail can be bent or curved. An actual size template is required. See pages 41-42 for more information. Polished chrome cannot be bent or curved.
- Wall or ceiling mount. See bracket count below.

0-5' = 2 brackets	11-15' = 4 brackets
6-10' = 3 brackets	16-20' = 5 brackets
- Motorize with any Forest Shuttle. See all motor specifications on pages 91-92. All Forest Shuttle motors include a 10 year warranty.
- Control drapes with a gentle tug, wall switch, remote, any home automation system or by smart phone app. See control options pages 93-94.

ASSEMBLED PRICING

Includes rail, Forest Shuttle motor, power supply, motor pulley, return pulley, single wall brackets, carriers, masters, and Diamond remote or wall switch. Finials are optional and should be ordered separately. Freight is additional.

DRESDEN MOTORIZED	first 4 feet	ea. add'l foot
Shuttle HD (M) white	\$3,617.20	\$159.76
Shuttle HD (M) black	\$3,978.90	\$175.74
Shuttle Eco (S)	\$3,546.79	\$159.76
Shuttle iOn	\$3,609.83	\$159.76

See all motor specifications on pages 91-92.

AVAILABLE FINISHES XX = finish color

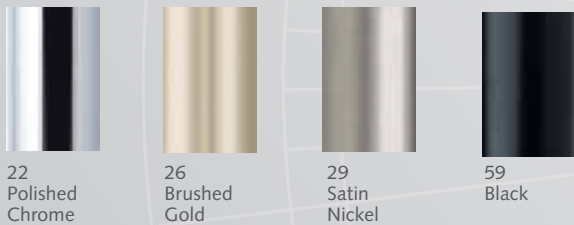

DRESDEN MOTORIZED FINIALS - OPTIONAL

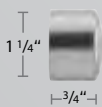

B124028-XX
End Cap Finial
\$56.65 ea.

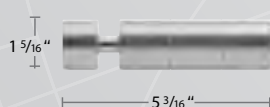

B690-XX
Pescara Finial
\$319.62 ea.

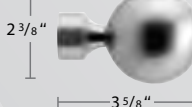

B3362-XX
Alassio Finial
\$323.64 ea.



B650-22, 29, 59
Verona Finial
\$438.48 ea.



B610-XX
Napoli Finial
\$401.96 ea.



B660-22, 24, 29, 70
Roma Finial
\$567.08 ea.

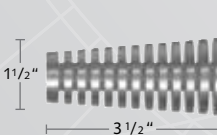

B3521-28-XX
Ischia Finial
\$277.76 ea.
not available in 26 Brushed Gold

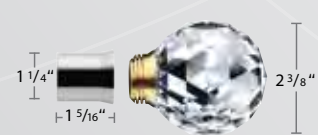

B3389-100
Ardea Finial \$540.64 ea.
B3389/1-XX
Socket for Ardea Finial \$108.72 ea.

DRAPERY MOTORIZATION

SHUTTLE MOTOR SPECIFICATIONS | CONTROLS ROADMAP | FMS | RMS | DSXL LED | HANOVER | **DRESDEN** | DEVENTER MRS | WOOD

DRESDEN	COMPONENT	PRICE	DRESDEN	COMPONENT	PRICE
	B809-28-XX 1 1/8" Aluminum Rail 19' 7"	\$57.95/ft.		B11670-V-XX Adjustable Wall Bracket	\$262.96 ea.
	B899-4-00 Rail Connector	\$48.05 ea.		B11873-50-XX Ceiling Bracket	\$110.40 ea.
	B11679-L-XX B11679-R-XX Shuttle Motor Pulley	\$667.54 ea.		B11873-15-XX Ceiling Bracket 5/8" Projection	\$68.78 ea.
	B11699-L-XX B11699-R-XX Somfy Motor Pulley	\$599.88 ea.		53408-22,24,29,59 Flush Ceiling Bracket Cannot use finials with this bracket	\$25.56 ea.
	B11649-L-22,29,59 B11649-R-22,29,59 Lutron Motor Pulley	\$777.55 ea.		Two Piece Connected Snap Carrier w/ Square Base, in plastic sleeve. Use 1 1/4" snap tape 2114-25, 59 black 60% fullness, 2 5/8" OC 2111-25, 65 brown, 90 grey 80% fullness, 2 3/8" OC 2112-25, 59 black 100% fullness, 2 1/8" OC 2115-25, 59 black 120% fullness, 1 7/8" OC	\$1.47 ea.  \$1.23 ea.  /roll of 500 Colors other than white +10%
	B11683-L-XX B11683-R-XX Return Pulley	\$303.43 ea.		52008-25 Slim Line Klick Carrier Draperies hand to conceal track	\$1.31 ea.  \$1.08 ea.  /box of 250
	B11682-XX Recess Bracket with Return Pulley	\$283.21 ea.		52009-25 Ball Bearing Carrier for motorization	\$1.84 ea.  \$1.51 ea.  /box of 250
	9012-25 Transport Belt Kevlar reinforced	\$14.02/ft.  \$11.66/ft.  /roll 328 ft.		52508-25 Overlap R 52509-25 Underlap L Belt Master Carrier	\$15.51 ea.  \$12.95 ea.  /box of 100
	52512-25 white 59 black +10% Transport Belt Connector	\$14.51 ea.  \$12.12 ea.  /box of 50		52508-25A Overlap R 52509-25A Underlap L Belt Master Carrier with snaps	\$18.39 ea.  \$15.33 ea.  /box of 100
	B11670-120-XX Single Bracket	\$189.07 ea.		52410-25 Butt Right 52409-25 Butt Left 59 black +10% Butt Master Carrier with snaps	\$21.38 ea.  \$17.80 ea.  /box of 50
	B11672-220-XX Double Bracket	\$214.43 ea.		2552-25 6" Extension Arm for master Use w/ two one-way draw	\$14.42 ea.  \$12.03 ea.  /box of 50

 **BREAK PACK PRICING**  - Prices with this designation indicate a 20% up charge for broken pack quantities.

DRAPERY MOTORIZATION

SHUTTLE MOTORS | CONTROLS ROADMAP | FMS | RMS | DSXL LED | HANOVER | **DRESDEN** | DEVENTER MRS | CORDOBA

WEAR RESISTANT PULLEY HOUSING

For low wear operation the pulley housing has been equipped with high quality ball bearings.



REINFORCED BELT

The Kevlar reinforced belt runs quietly and has superior longevity.

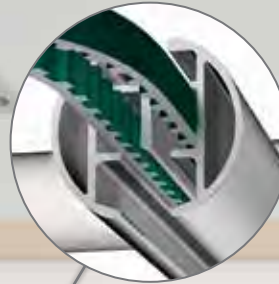





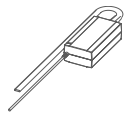

FOREST SHUTTLE MOTORS

- Touch Impulse Technology opens or closes drapes with a gentle tug.
- Integrated emergency control insures manual operation of the drapery in case of power failure.
- Choose the Forest Shuttle Eco for lightweight fabrics.
- Choose the Forest Shuttle HD for strength at an economical price.
- Choose the Shuttle iOn when a power source is not close by.
- All Forest Shuttle motors come with a 10-year warranty.

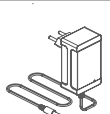
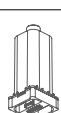

DRAPERY MOTORIZATION DRESDEN

DRESDEN	COMPONENT	PRICE
• 	52925-25 Shuttle HD (M) 52925-59 Shuttle HD (M) black 52939-25 Shuttle Eco (S) See motor specs on pages 91-92	\$1,338.39 ea. \$1,472.24 ea. \$1,062.81 ea. 1/box
• 	52928-25 Power Cord, 7' 6" 52934-25 Power Cord, 16' includes 24 volt power supply	\$170.18 ea. 1/box
• 	52926-25 Shuttle iOn Includes battery pack. Order charging cable below separately, 52924-59. See motor specs on pages 91-92	\$1,331.03 ea. 1/box
• 	52924-59 Battery Charger Charges battery included with Shuttle iOn motor above, 52926-25.	\$81.93 ea. 1/box
• 	52949-25 Battery Pack Additional battery pack for Shuttle iOn motor	\$506.17 ea. 1/box

DRESDEN	COMPONENT	PRICE
• 	52933-25 white 59 black +10% Forest Wall Switch 2 channel	\$213.73 ea. 1/box
• 	52931-25D white 59D black +10% Diamond Sense Remote RF, 15 channel w/ holder, range 98'	\$434.19 ea. 1/box
• 	52948-25 59 black +10% Wi-Fi Dongle For voice and app control over wi-fi. Provides feedback (bi-directional). Use with Shuttles HD and Eco.	\$265.36 ea. 1/box
• 	52955-25 Bond Bridge Pro For voice and app control over RF. Easily pair using the Forest remote. Controls all of your devices in one hub.	\$379.00 ea. 1/box no discounts taken on this item

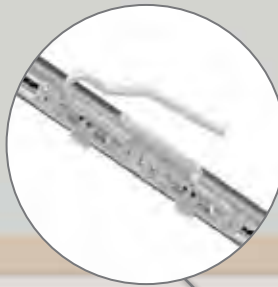

COMPLETELY CLOSED DRAPERIES USING OVERLAP MASTERS

The overlap master carrier guarantees a complete 3" overlap of the draperies. Extended arms available.



RETURN PULLEY

The return pulley is made of a special plastic and uses a bearing which allows ultra-smooth operation.



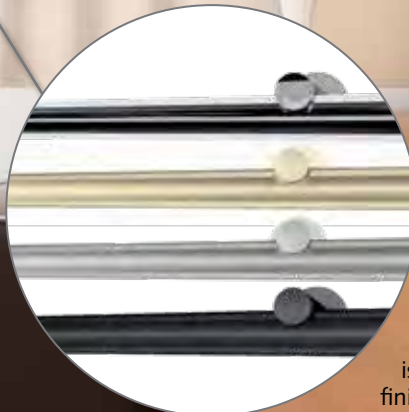
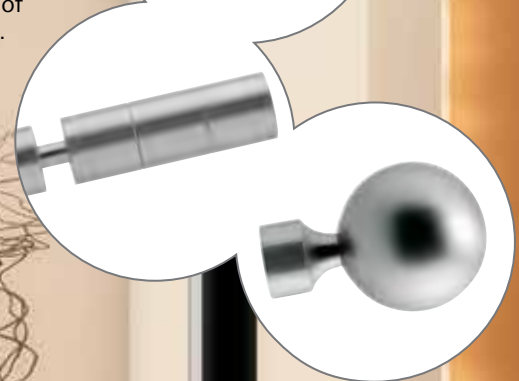

SELECT YOUR INDIVIDUAL FINIAL

Our decorative finials offer a variety of design options. See all finials on page 103. Finials are optional.



HIGH-GRADE ALUMINUM:

Dresden Motorized is available in the finishes below.

- Polished Chrome - 22 
- Brushed Gold - 26 
- Satin Nickel - 29 
- Black - 59 

DRAPERY MOTORIZATION

SHUTTLE MOTOR SPECIFICATIONS | CONTROLS ROADMAP | FMS | RMS | DSXL LED | HANOVER | DRESDEN | **DEVENTER MRS** | WOOD



Scan for more information on FOREST DEVENTER MRS MOTORIZED



AVAILABLE FINISHES XX = finish color



29 Satin Nickel



81 Antique Bronze



89 Graphite

DEVENTER MRS® MOTORIZED





- 1 1/8" motorized system best suited for light to medium weight draperies.
- Wall or ceiling mount. See bracket count below.
 - 0-5' = 2 brackets 11-15' = 4 brackets
 - 6-10' = 3 brackets 16-20' = 5 brackets
- Motorize with any Forest Shuttle. See all motor specifications on pages 91-92. All Forest Shuttle motors include a 10 year warranty.
- Control drapes with a gentle tug, wall switch, remote, any home automation system or by smart phone app. See control options pages 93-94.



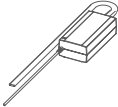

ASSEMBLED PRICING

Includes rail, motor, power supply, motor pulley, return pulley, wall or ceiling brackets, carriers, masters, and Diamond remote or wall switch. Double sets are available. Freight is additional.

DEVENTER MRS MOTORIZED	first 4 feet	ea. add'l foot
Shuttle HD (M) white	\$3,277.25	\$100.41
Shuttle HD (M) black	\$3,604.98	\$110.45
Shuttle Eco (S)	\$3,210.77	\$100.41
Shuttle iOn	\$3,364.43	\$100.41











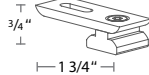
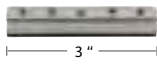

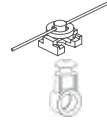



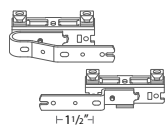

See all motor specifications on pages 91-92.

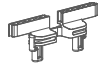
DEV MOT	COMPONENT	PRICE
• 	52925-25 Shuttle HD (M) 52925-59 Shuttle HD (M) black 52939-25 Shuttle Eco (S) See motor specs on pages 91-92	\$1,338.39 ea. \$1,472.24 ea. \$1,062.81 ea. 1/box
• 	52928-25 Power Cord, 7' 6" 52934-25 Power Cord, 16' includes 24 volt power supply	\$170.18 ea. 1/box
• 	52926-25 Shuttle iOn Includes battery pack. Order charging cable below separately, 52924-59. See motor specs on pages 91-92	\$1,331.03 ea. 1/box
• 	52924-59 Battery Charger Charges battery included with Shuttle iOn motor above, 52926-25.	\$81.93 ea. 1/box
• 	52949-25 Battery Pack Additional battery pack for Shuttle iOn motor	\$506.17 ea. 1/box

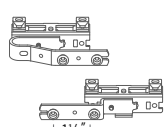
DEV MOT	COMPONENT	PRICE
• 	52933-25 white 59 black +10% Forest Wall Switch 2 channel	\$213.73 ea. 1/box
• 	52931-25D white 59D black +10% Diamond Sense Remote RF, 15 channel w/ holder, range 98'	\$434.19 ea. 1/box
• 	52948-25 59 black +10% Wi-Fi Dongle For voice and app control over wi-fi. Provides feedback (bi-directional). Use with Shuttles HD and Eco.	\$265.36 ea. 1/box
• 	52955-25 Bond Bridge Pro For voice and app control over RF. Easily pair using the Forest remote. Controls all of your devices in one hub.	\$379.00 ea. 1/box no discounts taken on this item

DRAPERY MOTORIZATION

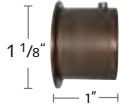
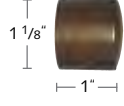
SHUTTLE MOTOR SPECIFICATIONS | CONTROLS ROADMAP | FMS | RMS | DSXL LED | HANOVER | DRESDEN | **DEVENTER MRS** | WOOD

DEV MOT	COMPONENT	PRICE	DEV MOT	COMPONENT	PRICE
●	 51919-XX 1 1/8" Aluminum Rail 19' 7"	\$56.21/ft.	●	 53408-25, 29, 59, 81 Flush Ceiling Bracket Cannot use finials	\$25.56 ea.
●	 53413-90 Rail Connector aluminum, 3"	\$23.76 ea. 25/box	●	Two Piece Connected Snap Carrier w/ Square Base, in plastic sleeve. Use 1 1/4" snap tape 2114-25, 59 black 60% fullness, 2 5/8" OC 2111-25, 65 brown, 90 grey 80% fullness, 2 3/8" OC 2112-25, 59 black 100% fullness, 2 1/8" OC 2115-25, 59 black 120% fullness, 1 7/8" OC	\$1.47 ea.  \$1.23 ea. /roll of 500 Colors other than white +10%
●	 51901-XX Left Motor Pulley 51902-XX Right Motor Pulley	\$463.60 ea.	●	 52008-25 59 black, 65 brown +10% Slim Line Klick Carrier Allows drapery to hang and conceal track	\$1.31 ea.  \$1.08 ea. /box of 250
●	 51903-XX Left Return Pulley 51904-XX Right Return Pulley	\$200.12 ea.	●	 52009-25 Ball Bearing Carrier	\$1.84 ea.  \$1.51 ea. /box of 250
●	 9012-25 Transport Belt Kevlar reinforced	\$14.02/ft.  \$11.66/ft. /roll 328 ft.	●	 52508-25 Overlap R 52509-25 Underlap L Belt Master Carrier	\$15.51 ea.  \$12.95 ea. /box of 100
●	 52512-25 white 59 black +10% Transport Belt Connector	\$14.51 ea.  \$12.12 ea. /box of 50	●	 52508-25A Overlap R 52509-25A Underlap L Belt Master Carrier with snaps	\$18.39 ea.  \$15.33 ea. /box of 100
●	 53402-XX Extended Single Bracket	\$92.22 ea. 2/box	●	 52410-25 Butt Right 52409-25 Butt Left 59 black +10% Butt Master Carrier with snaps	\$21.38 ea.  \$17.80 ea. /box of 50
●	 53412-XX Inside Mount Bracket	\$110.78 ea.			
●	 52430-XX End Cap Finial	\$48.47 ea. 10/box			
●	 52431-XX Ball Finial	\$101.60 ea. 10/box			
●	 52432-XX Notched Finial	\$55.97 ea. 10/box			

 **BREAK PACK PRICING**  - Prices with this designation indicate a 20% up charge for broken pack quantities.

DRAPERY MOTORIZATION

SHUTTLE MOTOR SPECIFICATIONS | CONTROLS ROADMAP | FMS | RMS | DSXL LED | HANOVER | DRESDEN | DEVENTER MRS | WOOD



Scan for more information on FOREST MOTORIZED WOOD



2" & 2 3/4" WOOD MOTORIZED

- Forest FMS Track with wood pole fascia in 2" or 2 3/4" diameters.
- Motorize with any Forest Shuttle. See all motor specifications on pages 91-92. All Forest Shuttle motors include a 10 year warranty.
- Control drapes with a gentle tug, wall switch, remote, any home automation system or by smart phone app. See control options pages 93-94.

ASSEMBLED PRICING



Includes assembled track, wood fascia, motor, power supply, single wall brackets, and Diamond remote or wall switch. Freight is additional.



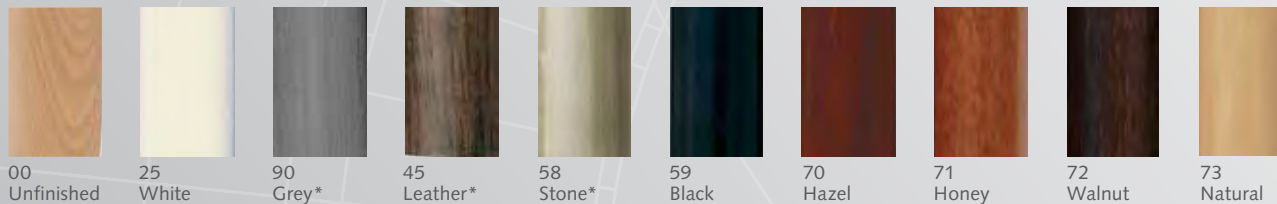

WOOD MOTORIZED	HD (M) white first 4 feet	Eco (S) first 4 feet	iOn first 4 feet	All ea. add'l ft.
2" Single Unfinished	\$2,459.04	\$2,251.62	\$2,245.58	\$68.16
2" Single Finished	\$2,529.59	\$2,322.20	\$2,316.14	\$82.96
2" Double Unfinished	\$4,661.66	\$4,454.25	\$4,448.20	\$121.48
2" Double Finished	\$4,742.70	\$4,535.29	\$4,529.24	\$128.89
2 3/4" Single Unfinished	\$2,529.44	\$2,322.02	\$2,315.98	\$85.93
2 3/4" Double Unfinished	\$4,888.19	\$4,680.79	\$4,674.74	\$143.70

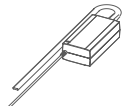
AVAILABLE FINISHES XX = finish color, *smooth poles only

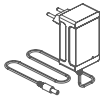
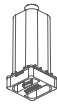

DRAPERY MOTORIZATION WOOD

WOOD	COMPONENT	PRICE
•	 52925-25 Shuttle HD (M) 52925-59 Shuttle HD (M) black 52939-25 Shuttle Eco (S) See motor specs on pages 91-92	\$1,338.39 ea. \$1,472.24 ea. \$1,062.81 ea. 1/box
•	 52928-25 Power Cord, 7' 6" 52934-25 Power Cord, 16' includes 24 volt power supply	\$170.18 ea. 1/box
•	 52926-25 Shuttle iOn Includes battery pack. Order charging cable below separately, 52924-59. See motor specs on pages 91-92	\$1,331.03 ea. 1/box
•	 52924-59 Battery Charger Charges battery included with Shuttle iOn motor above, 52926-25.	\$81.93 ea. 1/box
•	 52949-25 Battery Pack Additional battery pack for Shuttle iOn motor	\$506.17 ea. 1/box

WOOD	COMPONENT	PRICE
•	 52933-25 white 59 black +10% Forest Wall Switch 2 channel	\$213.73 ea. 1/box
•	 52931-25D white 59D black +10% Diamond Sense Remote RF, 15 channel w/ holder, range 98'	\$434.19 ea. 1/box
•	 52948-25 59 black +10% Wi-Fi Dongle For voice and app control over wi-fi. Provides feedback (bi-directional). Use with Shuttles HD and Eco.	\$265.36 ea. 1/box
•	 52955-25 Bond Bridge Pro For voice and app control over RF. Easily pair using the Forest remote. Controls all of your devices in one hub.	\$379.00 ea. 1/box no discounts taken on this item

DRAPERY MOTORIZATION

SHUTTLE MOTOR SPECIFICATIONS | CONTROLS ROADMAP | FMS | RMS | DSXL LED | HANOVER | DRESDEN | DEVENTER MRS | **WOOD**

WOOD	COMPONENT	PRICE	WOOD	COMPONENT	PRICE
	 <p>51323-25 white 59 black +10% FMS Track 23' x 10 tracks per bundle bundle = 230'</p>	\$7.00/ft.		 <p>52008-25 59 black +10% Slim Line Klick Carrier Draperies hang to conceal track</p>	\$1.31 ea. \$1.08 ea. /box of 250
	 <p>1051RSW-XX 2" Cordoba Smooth, 14' 1072RSW-00 2 3/4" Granada Smooth, 13'</p>	See pricing pages 63 & 65		 <p>52009-25 Ball Bearing Carrier for motorization</p>	\$1.84 ea. \$1.51 ea. /box of 250
	 <p>1051RRW-XX 2" Cordoba Reeded, 14' 1072RSW-00 2 3/4" Granada Reeded, 13'</p>	See pricing pages 63 & 65		 <p>52508-25 Overlap Right 52509-25 Underlap Left 59 black +10% Belt Master Carrier</p>	\$15.51 ea. \$12.95 ea. /box of 100
	 <p>1151WEN-XX 2" Cordoba End Cap 1172WEN-XX 2 3/4" Granada End Cap See all finials pages 60 & 62</p>	See pricing pages 63 & 65		 <p>52508-25A Overlap Right 52509-25A Underlap Left 59A black +10% Belt Master Carrier with snaps</p>	\$18.39 ea. \$15.33 ea. /box of 100
	 <p>3906-25 59 black +10% Track Connector & key 3904-00</p>	\$20.37 ea.		 <p>52410-25 Butt Right 52409-25 Butt Left 59 black +10% Butt Master Carrier with snaps</p>	\$21.38 ea. \$17.80 ea. /box of 50
	 <p>3280-25 59 black +10% 3" Single Wall Bracket heavy duty projection 2 1/2"</p>	\$14.58 ea. \$12.15 ea. /box of 20		 <p>2552-25 6" Extension Arm for master Use w/ two one-way draw</p>	\$14.42 ea. \$12.03 ea. /box of 50
	 <p>3281-25 59 black +10% 6" Double Wall Bracket heavy duty projection 1 1/2", 5 1/2"</p>	\$20.90 ea. \$17.41 ea. /box of 15		 <p>52903-25 59 black +10% Motor Pulley Connects motor to track</p>	\$74.45 ea. 1/box
	 <p>32801-25 59 black +10% Wall Bracket Cover use with 3280 & 3281</p>	\$3.76 ea. \$3.13 ea. /box of 50		 <p>52910-25 59 black +10% Return Pulley</p>	\$42.80 ea. 1/box
	 <p>2114-25 60% fullness 2 5/8" OC 2111-25 80% fullness 2 3/8" OC 2112-25 100% fullness 2 1/8" OC 2115-25 120% fullness 1 7/8" OC 59 black +10% Two-Piece Connected Snap Carrier w/ Square Base, use 4 1/4" snap tape.</p>	\$1.47 ea. \$1.23 ea. /roll of 500		 <p>9012-25 Transport Belt Kevlar reinforced</p>	\$14.02/ft. \$11.66/ft. /roll 328 ft.
				 <p>52512-25 white 59 black +10% Transport Belt Connector</p>	\$14.51 ea. \$12.12 ea. /box of 50

BREAK PACK PRICING - Prices with this designation indicate a 20% up charge for broken pack quantities.

TERMS & CONDITIONS

Applicant, to induce Forest Drapery Hardware (FDH) to consider providing goods on credit to Applicant, hereby agrees for itself, its successors, and permitted assigns, that the following terms and conditions shall apply to all sales of goods (the "Goods") by FDH to applicant.

1. Applicant is applying for credit for business purposes. Applicant authorizes all financial institutions and business entities of which FDH may from time to time make inquiry to provide FDH such financial information, as FDH deems necessary to make credit decisions. FDH has no obligation to extend credit to Applicant and may in its sole discretion suspend, terminate or reduce the limits of any extensions of credit at any time and withhold shipments of Goods ordered, or require cash in advance, in the event FDH, in its sole discretion, finds Applicant's financial condition to be unsatisfactory.
2. FDH will provide to Applicant an itemized invoice for each sale. If Applicant does not give written notice to FDH within fifteen (15) calendar days from the date of such invoice of any objection to the Goods listed, the receipt thereof, that such purchase was unauthorized or any other objection, all such objections shall be deemed waived. Applicant waives any and all right to set off claims, which it may assert against FDH, and/or to withhold payment to FDH based on a claim that FDH is indebted to Applicant. No claim asserted by Applicant against FDH shall relieve Applicant of its obligation to make timely payments to FDH.
3. Except as otherwise set forth in a FDH Invoice, payment is due by the 30th day following the date of the invoice. Payments become past due after the 30th day. Applicant agrees that all amounts in past due shall bear interest at 1.5% per month pre- and post-judgement until paid and agrees to pay FDH, in addition to the amount due, attorneys' fees of fifteen percent (15%) of the amount due, or the maximum amount allowed by law, whichever is greater, in the event the account is placed in collections with an attorney, or any other means of collection, and also to pay any and all attorneys' fees and costs associated with post-judgement collection preparation and recording fees. Applicant agrees that all payments shall be applied to Applicant's account as designated in writing and if not designated in writing then FDH shall apply said payments to the most outstanding invoices. This Agreement shall be deemed fully executed and performed in Bartow County, Georgia, and will be governed and construed in accordance with the laws of Georgia. Applicant agrees to examine all invoices and statements promptly upon receipt and to notify FDH immediately at any failure of delivery, shortage, discrepancy or error and further agrees that such invoice or statement shall be presumed correct unless Applicant shall notify FDH in writing of such failure of delivery, shortage, discrepancy or error within thirty (30) calendar days of Applicant's receipt of such invoice or statement. Use of materials by Applicant shall constitute a waiver of any error in shipment or defect in materials, which might have been determined by a prompt and diligent inspection thereof.
4. Any waiver or non-enforcement by FDH of a breach, default or term under this Agreement shall not be deemed a waiver of any subsequent breach or default of enforcement of such term and FDH shall only be deemed to have given as much in writing executed by FDH providing for such waiver. If any provision of this Agreement is waived by FDH or is held to be invalid or unenforceable, all other provisions shall nevertheless continue in full force and effect as if such provision were not contained herein.
5. This Agreement contains the entire agreement and understanding between FDH and Applicant with respect to the sale of Goods by FDH to Applicant (other than payment terms and delivery dates to be set forth in FDH invoices), supersedes all prior agreements, commitments, representations and discussions between FDH and Applicant and is not assignable by Applicant without the prior written consent of FDH. No modifications, amendments or additions to this agreement will be binding on FDH unless such modification, amendment or addition is in writing executed by FDH. Without limitation of the forgoing, the terms hereof shall not be modified, amended or added to by the terms of any purchase order or similar document submitted by Applicant to FDH. The terms here of shall be altered or interpreted by reference to any course of dealing between FDH and Applicant of industry practice. Any action by Applicant instituted against FDH arising from Goods sold must be commenced within one (1) year from date of delivery of the subject of Goods.
6. Applicant shall have seven (7) calendar days from the date of delivery to reject Goods as nonconforming. Such rejection must be in writing received by FDH within such seven (7) calendar days, and specify the Goods rejected and the specific nonconformity asserted and the subject Goods must be received by FDH within ten (10) calendar days from the delivery date of Goods. All Goods not so rejected shall conclusively be deemed to have been accepted. In order to effect such rejection, the Goods returned must be accompanied by a copy of the original invoice or other proof of purchase by Applicant. No charges or expenses incident to any claims will be allowed unless approved by an authorized representative of FDH. Goods shall not be returned to FDH without FDH permission and such returns will only be accepted when return authorization numbers, given by FDH, is mentioned on the Goods and bill of lading. Physical acceptance by FDH of Goods returned may in no way be deemed agreement by FDH of any claim by Applicant of nonconformity.
7. FDH shall have a reasonable time after receipt of proper notice of rejection of nonconformity Goods of revocation of acceptance of nonconformity Goods to repair or replace the Goods or refund the purchase price, with the remedy to be selected by FDH in its sole discretion. If Applicant otherwise has an outstanding balance, the refund shall be in the form of a credit to Applicant's account.
8. Applicant is responsible for determining the Goods it chooses to purchase and for what purposes those Goods will be used and Applicant will not be relying on the skill or judgment of FDH to select or furnish Goods suitable for any particular purpose. FDH MAKES NO REPRESENTATIONS OR WARRANTIES, EXPRESS OR IMPLIED, INCLUDING BUT NOT LIMITED TO WARRANTIES OF FITNESS OR SUITABILITY FOR ANY PURPOSE, AND/OR THE MERCHANTABILITY OF ANY GOODS. Applicant agrees that its sole and exclusive remedy against FDH for defective or nonconforming Goods shall be repair or replacement of such Goods, or refund of purchase price, with the remedy to be selected by FDH at its sole discretion. Applicant hereby waives all other remedies, and in no event shall FDH be liable for any negligence or general, incidental, special, consequent or other damages suffered by Applicant or any other party for lost profit, sales, labor, injury to person or property or any other loss. FDH may deliver certain third-party manufacturer warranties to Applicant, but FDH shall have no liability under such warranties.
9. The undersigned unconditionally personally guarantees the timely payment of all amounts due from Applicant to FDH and agrees to be jointly and severally liable with the Applicant to FDH for any debt owed by the Applicant, The undersigned agrees to pay reasonable attorneys' fees equal to 15% of the outstanding principal and interest owed by the Applicant in the event that the Applicant's account is placed in collections with an attorney or any other means of collection. This personal guarantee may only be revoked in writing sent by certified mail to FDH. Said revocation shall not be effective as to any balance owed prior to receipt of said revocation. The undersigned hereby expressly waives notice of acceptance of this instrument, notice of any default, non-payment, partial payment, presentment, protest, demand and any and all other notices whatsoever.

ORDERING INFORMATION



OPEN AN ACCOUNT

Forest sells to the trade only. If you are a member of the trade and want to open an account, consider that volume of purchases from Forest will determine your discount structure. Using a local distributor may save you shipping time and provide better pricing. See below to find a distributor in your area. If you would like to open an account with Forest, scan this code to go to the new customer forms on the Forest website. forestdh.com/new-customer-forms.



FIND A DISTRIBUTOR

Buying from a local distributor may save you shipping time and provide better pricing. Need to find a distributor of Forest products? If so, scan this code to find a distributor in your area. forestdh.com/find-a-distributor

TO GET A QUOTE OR TO PLACE AN ORDER

We only accept orders in writing, not by phone. Please e-mail your customer service representative or customerservice@forestdh.com with your order information.

QUESTIONS ON AN ORDER

E-mail or call with your sales order number and we will be happy to help! Our office is open M-F, 8:30 am - 5:30 pm Eastern Time.
 P: 678-721-0004
 E: customerservice@forestdh.com

RETURNS, WARRANTY & CARE

FREIGHT/SHIPPING

Orders will be shipped via the most economical way. Freight charges will be added to invoice. The Forest Drapery Hardware Freight Policy is available online at forestdh.com/new-customer-forms.

RETURNS

All returns must be approved prior to returning by requesting an RGA authorization number. A 25% restocking fee will be applied. No returns accepted after 30 days of receipt of order or on custom orders.

PAYMENT

We accept Visa, Mastercard, American Express & Discover Card. Our invoice price is for check payment. We reserve the right to add a convenience fee for credit card payments. Credit is available upon submittal and approval of a credit application.

SHORTAGES/DAMAGES

Immediately upon receipt, your order should be inspected for shortages, damages, and to insure that there is no concealed damage from shipping. Claims on damages or shortages must be made within 3 days. Please note on the Bill of Lading if there is any possibility of damage. If your driver requires a digital signature, please request an EXCEPTION NUMBER from the driver before signing. Black marks, holes, open ends, over-boxing, re-taping, torn boxes etc., constitutes damage or possible shortage. No concealed damage claims will be filed as they are automatically denied by all carriers. You will be responsible for damaged freight not properly noted on delivery receipt. Our policy is that we replace damaged products per the original order and ship via the original carrier. If your order is damaged in shipping, carriers require that ALL packing materials be kept in order for a representative to inspect the goods. You will be billed for any replacement cost if a freight claim is denied. Replacements for undelivered goods will be sent after freight company has had a reasonable time to deliver order.

WARRANTY

Forest Drapery Tracks are warranted for 10 years. Forest Motors are warranted for 10 years with the exception of the Forest Lithium Battery Tubular Motor for RBS which is warranted for 1 year. Forest Roller Shades are warranted for 1 year. Warranties do not apply to wear resulting from normal usage, damage from mishandling, alterations from original state, abuse, or exposure due to climate conditions over which we have no control. The Tavira collection is the only category warranted for outdoor use, 1 year. Forest Drapery Hardware does not cover the shipping costs for the return or replacement of warranty items.

CARE

Products can be cleaned with a damp cloth. Do not use any type of cleaner or solvent.

APPENDIX

TERMS & CONDITIONS | ORDERING INFORMATION | RETURNS, WARRANTY & CARE | **CARRIER COUNTS** | PRODUCT SUPPORT

RIPPLEFOLD CARRIER COUNTS

For Overlap Masters

No. of Full Spaces Required	Fabric Width Hemmed	Panel Coverage 120% Fullness	Panel Coverage 100% Fullness	Panel Coverage 80% Fullness	Panel Coverage 60% Fullness	* No. of Carriers
7	35 1/2	11-14	12-16	14-17	14-19	8
9	44	15-18	17-20	18-22	20-24	10
11	52 1/2	19-21	21-24	23-27	25-30	12
13	61	22-25	25-28	28-32	31-35	14
15	69 1/2	26-29	29-32	33-36	36-40	16
17	78	30-33	33-37	37-41	41-45	18
19	86 1/2	34-36	38-41	42-46	46-51	20
21	95	37-40	42-45	47-51	52-56	22
23	103 1/2	41-44	46-50	52-55	57-61	24
25	112	45-48	51-54	56-60	62-66	26
27	120 1/2	49-51	55-58	61-65	67-72	28
29	129	52-55	59-62	66-70	73-77	30
31	137 1/2	56-59	63-66	71-74	78-82	32
33	146	60-63	67-71	75-79	83-87	34
35	154 1/2	64-66	72-75	80-84	88-93	36
37	163	67-70	76-79	85-89	94-98	38
39	171 1/2	71-74	80-84	90-93	99-103	40
41	180	75-78	85-88	94-98	104-108	42
43	188 1/2	79-81	89-92	99-103	109-114	44
45	197	82-85	93-96	104-108	115-119	46
47	205 1/2	86-89	97-101	109-112	120-124	48
49	214	90-93	102-105	113-117	125-129	50
51	222 1/2	94-96	106-109	118-122	130-135	52
53	231	97-100	110-113	123-127	136-140	54
55	239 1/2	101-104	114-118	128-131	141-145	56

No. of Full Spaces Required	Fabric Width Hemmed	Panel Coverage 120% Fullness	Panel Coverage 100% Fullness	Panel Coverage 80% Fullness	Panel Coverage 60% Fullness	* No. of Carriers
57	248	105-108	119-122	132-136	146-150	58
59	256 1/2	109-111	123-126	137-141	151-156	60
61	265	112-115	127-130	142-146	157-161	62
63	273 1/2	116-119	131-136	147-150	162-166	64
65	282	120-123	137-139	151-155	167-171	66
67	290 1/2	124-126	140-143	156-160	172-176	68
69	299	127-130	144-147	161-165	177-182	70
71	307 1/2	131-134	148-152	166-169	183-187	72
73	316	135-138	153-156	170-174	188-192	74
75	324 1/2	139-141	157-160	175-179		76
77	333	142-145	161-164	180-184		78
79	341 1/2	146-149	165-168	185-188		80
81	350	150-153	169-173	189-193		82
83	358 1/2	154-156	174-177			84
85	367	157-160	178-181			86
87	375 1/2	161-164	182-186			88
89	384	165-168	187-190			90
91	392 1/2	169-171				92
93	401	172-175				94
95	409 1/2	176-179				96
97	418	180-183				98
99	426 1/2	184-186				100
101	435	187-190				102

* Includes one carrier (button position only) for attachment to master.

APPENDIX

TERMS & CONDITIONS | ORDERING INFORMATION | RETURNS, WARRANTY & CARE | **CARRIER COUNTS** | PRODUCT SUPPORT

RIPPLEFOLD CARRIER COUNTS

For Butt Masters

No. of Full Spaces Required	Fabric Width Hemmed	Panel Coverage 120% Fullness	Panel Coverage 100% Fullness	Panel Coverage 80% Fullness	Panel Coverage 60% Fullness	* No. of Carriers
7	34	13-13	13-14	13-16	16-18	8
9	42 1/2	14-16	15-19	17-21	19-23	10
11	51	17-20	20-23	22-26	24-28	12
13	59 1/2	21-24	24-27	27-30	29-34	14
15	68	25-28	28-31	31-35	35-39	16
17	76 1/2	29-31	32-36	36-40	40-44	18
19	85	32-35	37-40	41-45	45-49	20
21	93 1/2	36-39	41-44	46-49	50-55	22
23	102	40-43	45-48	50-54	56-60	24
25	110 1/2	44-46	49-53	55-59	61-65	26
27	119	47-50	54-57	60-64	66-70	28
29	127 1/2	51-54	58-61	65-68	71-76	30
31	136	55-58	62-65	69-73	77-81	32
33	144 1/2	59-61	66-70	74-78	82-86	34
35	153	62-65	71-74	79-83	87-91	36
37	161 1/2	66-69	75-78	84-87	92-97	38
39	170	70-73	79-82	88-92	98-102	40
41	178 1/2	74-76	83-87	93-97	103-107	42
43	187	77-80	88-91	98-102	108-112	44
45	195	81-84	92-95	103-106	113-118	46
47	204	85-88	96-99	107-111	119-123	48
49	212 1/2	89-91	100-104	112-116	124-128	50
51	221	92-95	105-108	117-121	129-133	52
53	229 1/2	96-99	109-112	122-125	134-139	54
55	238	100-103	113-116	126-130	140-144	56

No. of Full Spaces Required	Fabric Width Hemmed	Panel Coverage 120% Fullness	Panel Coverage 100% Fullness	Panel Coverage 80% Fullness	Panel Coverage 60% Fullness	* No. of Carriers
57	246 1/2	104-106	117-121	131-135	145-149	58
59	255	107-110	122-125	136-140	150-154	60
61	263 1/2	111-114	126-129	141-144	155-160	62
63	272	115-118	130-133	145-149	161-165	64
65	280 1/2	119-121	134-138	150-154	166-170	66
67	289	122-125	139-142	155-159	171-175	68
69	297 1/2	126-129	143-146	160-163	176-181	70
71	306	130-133	147-150	164-168	182-186	72
73	314 1/2	134-136	151-155	169-173	187-191	74
75	323	137-140	156-159	174-178	192-196	76
77	331 1/2	141-144	160-163	179-182		78
79	340	145-148	164-167	183-187		80
81	348 1/2	149-151	168-172	188-192		82
83	357	152-155	173-176	193-197		84
85	365 1/2	156-159	177-180			86
87	374	160-163	181-184			88
89	382 1/2	164-166	185-189			90
91	391	167-170	190-193			92
93	399 1/2	171-174				94
95	408	175-178				96
97	416 1/2	179-181				98
99	425	182-185				100
101	433 1/2	186-189				102
103	442	190-193				104

* Includes one carrier (button position only) for attachment to master.

PRODUCT SUPPORT



FOREST WEBSITE – FORESTDH.COM

- Catalog & Spec Sheets
- Assembly & Installation Instructions
- Technical Manuals
- Trade Show Schedule



PRODUCT CATALOGS

The Forest product catalog contains over 100 pages of product available in our Atlanta warehouse. See the catalog in print or online.



DECORATIVE HARDWARE FINISH SWATCH BINDER

The Forest finish swatch binder contains physical samples of each finish in our decorative metal and wood collections, a swatch card of our in-stock roller shade fabrics, and a product catalog.



ROLLER SHADE FABRIC SWATCH CARD

The Forest roller shade fabric swatch card allows you to see and feel our stock fabrics email customerservice@forestdh.com

PRODUCT SUPPORT



FOREST CHANNEL

Programming, Assembly, Tips & Tricks





STARTER MARKETING KIT FOR YOUR SHOWROOM

The standard kit includes a box of catalogs, a finish swatch binder, a roller shade fabric swatch card, a wall display (with 10 hardware samples), and a motorized sample up to 8' wide (choice of track, metal, wood or roller shade). Kit is valued at \$1,745. Forest will take it back in 150 days if it does not sell for you.

STANDARD Starter Marketing Kit \$550.00
 CUSTOM Starter Marketing Kit \$1,100.00



DRAPERY HARDWARE WALL DISPLAY

Boards (11) – Top logo board plus ten acrylic boards with hardware set attached, 25 1/4"W x 3 7/8"H
 Rails – Pair of wall mount rails that sample boards mount onto, 53 1/8"H
 STANDARD Wall Display \$275.00/set



PRODUCT TRAINING

Forest sales managers will train you and your customers at your facility or ours. Call today to schedule a group presentation, lunch & learn, or an open house – 678-721-0004.

WARNING



Window Blind Cord Can STRANGLE Your Child

- Children can climb furniture to reach cords.
- Move crib and furniture away.
- Keep all cords out of children's reach.
- Attach tension device to wall or floor.
- Fasteners provided with the tension device may not be appropriate for all mounting surfaces.
- Use appropriate anchors for the mounting surface conditions.

CHILD SAFETY

All Forest custom assembled products containing cords meet ANSI/WCMA A100.1-2018 child safety standards and include a tension device and a warning label like the one to the left.





THE WORLD BEHIND YOUR DRAPERIES

WWW.FORESTDH.COM

For a distributor in your area go to www.forestdh.com
or call 678-721-0004.

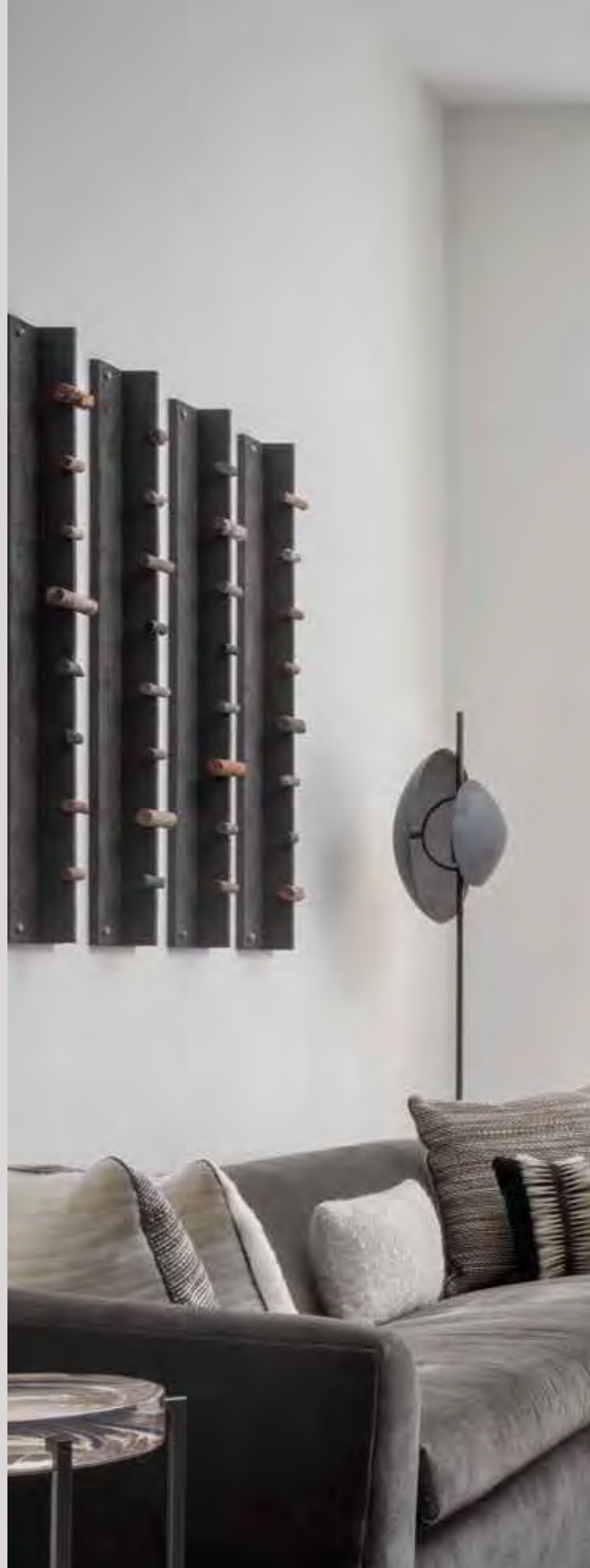

© Copyright 2024 Forest Drapery Hardware

All returns must be approved prior to returning. A 25% restocking fee will be applied. No returns accepted after 30 days of receipt of order or on custom orders. Please inspect all packages upon receipt, note any loss or damage on the freight bill and immediately notify Forest Drapery Hardware. Claims must be reported within three business days. Forest Drapery Tracks are warranted for 10 years. All Forest Shuttle motors and the Forest Atlantis motor are warranted for 10 years. All other motors are warranted for 1 year. Forest Roller Shades are warranted for 1 year. Warranties do not apply to wear resulting from normal usage, damage from mishandling, abuse, or exposure due to climate conditions over which we have no control. The Tavira collection is the only category warranted for outdoor use, 1 year. All prices subject to change without notice.