

ORION

ORNAMENTAL IRON, INC.

Iron Art™
by ORION

Wood Art™
by ORION

2022 DECORATIVE DRAPERY HARDWARE CATALOG

Hand Crafted with Pride Since 1983



*Iron Art*TM by **ORION**

☞ 3D Drapery Hardware (Finials in Front of Rod)	26
☞ 3D Drapery Panels (Finials and Stationary Panels in Front of Rod)	30
☞ Accessories	19
☞ Batons	23
☞ Brackets/Decorative Brackets	20
☞ Burgundy Collection (Hand Crafted Decorative Rods)	34
☞ Cornices, Crowns, and Decorative Scroll Work	
Mediterranean Collection (Lightweight Decorative Crowns)	36
Renaissance Collection (Lightweight Decorative Cornices)	37
Tuscany Collection (Decorative Metal Cornices, Available While Supplies Last)	38
Vienna Collection (Decorative Scrolls)	36
☞ Fina Collection (Thin Line Drapery Hardware)	25
☞ Finials	
Bohemia Collection (Decorative Hand Crafted Faceted Crystal-Glass Finials)	62
Eclectic Collection (Glass & Rattan Finials, Discontinued)	18
Iron Finials	10
Italian Collection (Metal Plated Iron Drapery Hardware)	58
Provence Collection (Decorative Hand Blown Art Glass Finials, Discontinued)	18
Village Forge Collection (Hand Crafted Iron Finials)	17
☞ Iron Art TM Finishes	80
☞ Italian Collection (Metal Plated Iron Drapery Hardware)	58
☞ Italian Collection Finishes	61
☞ Milano Collection (Roman Shades on Drapery Hardware, Available While Supplies Last)	25
☞ Oasis Collection (Expandable Sets)	24
☞ Rings	21
☞ Rods	19
☞ Swing Arms	21
☞ Tiebacks/Swag Holders	22
☞ Tropical Collection (Faux Bamboo on Iron, Available While Supplies Last)	32
☞ Unique Collection (Bypass System with “C” Rings)	24
☞ Xpress Yourway (Orion’s Quickship Program)	6

Manual and Motorized Traversing

☞ Deco Lite Traversing (Lightweight Embossed Metal Panels, Available While Supplies Last)	50
☞ Designers’ Choice Traversing Rods (Iron Traversing Rods with Heavy Duty Hardware)	44
☞ Manual Traversing Accessories	49
☞ Motorized Traversing Accessories	56
☞ Traversing with Somfy Motorization	52
☞ Tuscany Traversing Collection (Lightweight Embossed Metal Rods and Heavy Duty Hardware, Available While Supplies Last)	46
☞ Measurement Guidelines	83
☞ Promotional Items/Designer Product Case	79
☞ Xpress Yourway (Orion’s Quickship Program)	6

*Iron Art*TM *by* **ORION**

From our humble beginnings as an iron workshop manufacturing gates and fences in 1983, Orion Ornamental Iron, Inc. has grown into an established and well-known national brand in the drapery hardware industry. Our diverse collections, many of them award-winning, cover a wide range of décor styles and drapery hardware functions to meet the needs of today's designers.

We are best known for our Iron ArtTM collection. It includes a varied array of over 150 finials, traditional rods with rings or traversing systems with manual or motorized draw options, coordinating rings and brackets in a wide variety of choices, and plenty of accessories, all available in 35 beautiful Iron ArtTM finishes. And since customization is our specialty, whether it's creating a finish, fabricating custom parts, or making a custom design, Orion can offer you a complete drapery hardware solution.



What's New

- New Italian Collection 7 New Finishes
- New Somfy's Movelite 35™
- New Clear Vue Collection - Acrylic Drapery Hardware

**Please call to inquire more information
about products**

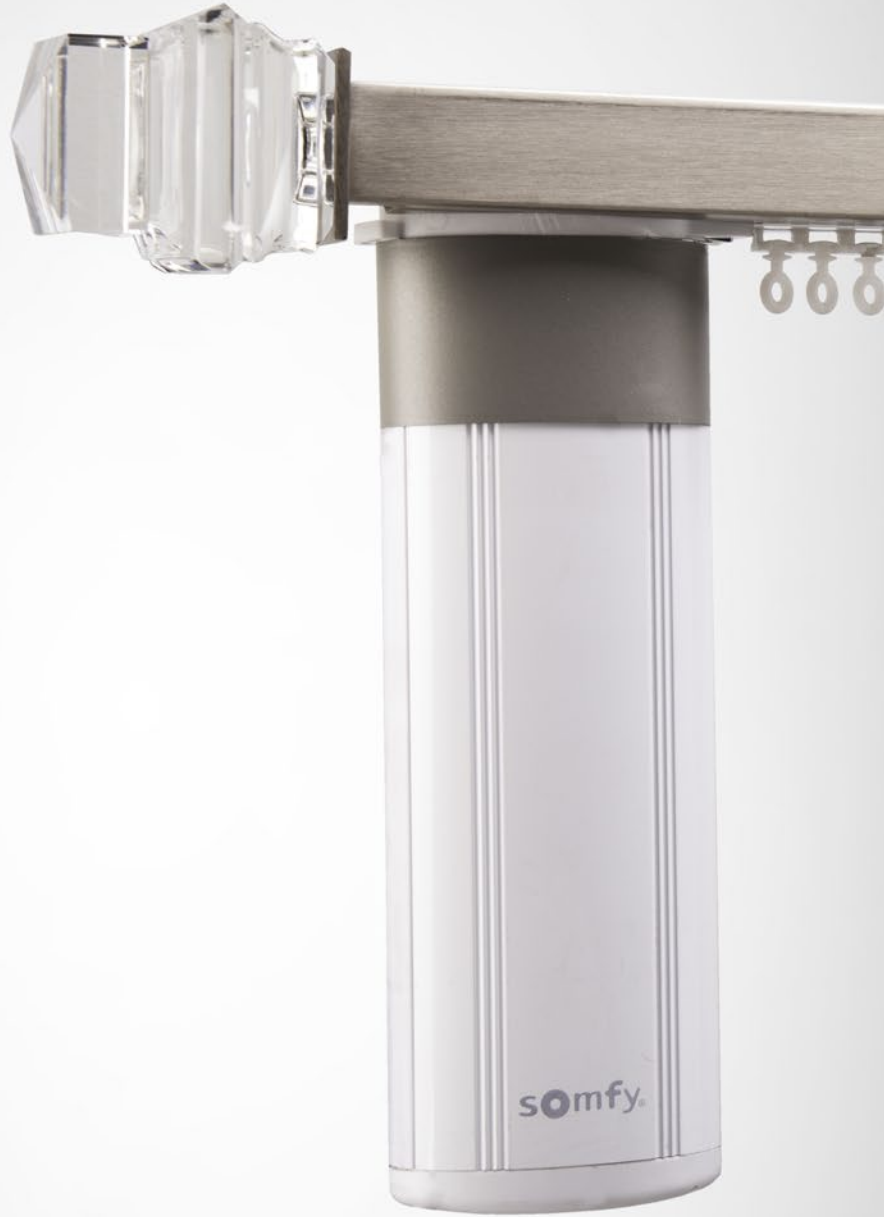

Our most popular Iron Art™, Bohemia, and Italian finials with expedited shipping.

Two finish collections determine the shipping speed. Express It! finishes are shipped the next business day while Quicken It! finishes are shipped within 3 business days. Choose from eight finials in our Iron Art™ line, three finials in our Italian line, or nine Bohemia Crystal finials for either line. Complete your set with mounting hardware, rings, and accessories!

Iron Art Line - 1" and 1½" rod sizes, eight finials, and eight finishes. Coordinate with accessories, brackets, and rings.

Express It! Finishes
Next Day Shipping

Quicken It! Finishes
3 Day Shipping



Black (A)



Brown (A)

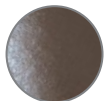

Light Brown (A)
(New!)



New Nickel (B)
(New!)



Antique Bronze



Antique Gold



Pure White



Soft Pewter



513
(1" x 2¼")



420
(1¾" x 2")



946
(2" x 2")



505
(2¼" x 1½")



947L
(2½" x 2½")



906S
(3¼" x 3")



966
(3½" x 2¼")



950
(5¼" x 2½")

Expandable Post Projection Tiebacks
(3" to 4½" projection)



1059 Rosette
(3" Diameter)



1073
(3½" Diameter)



1078
(3¾" x 3¾")

1" and 1½" rod sizes, eight finials, and eight finishes. Coordinate with accessories, brackets, and rings. - **Iron Art Line**

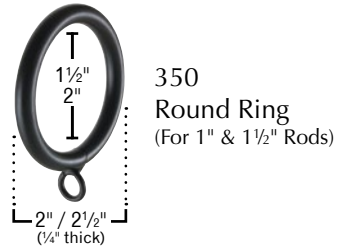
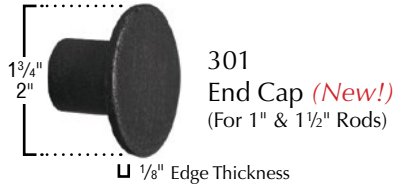
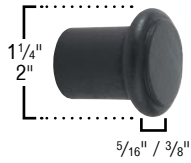

Mounting Brackets

Sockets

1028 Series

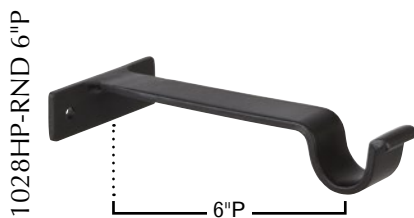
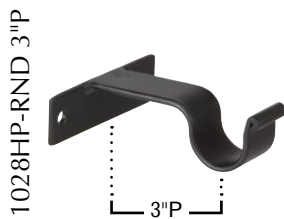
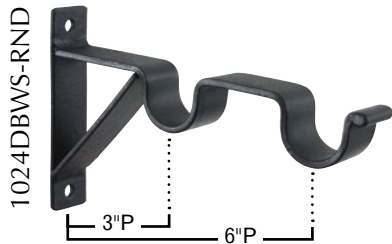

1040 Series (New!)

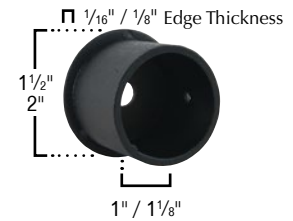
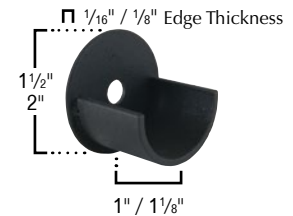
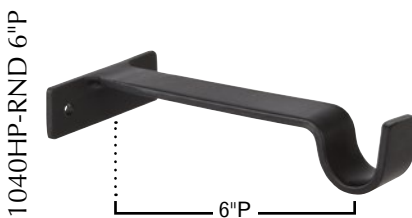
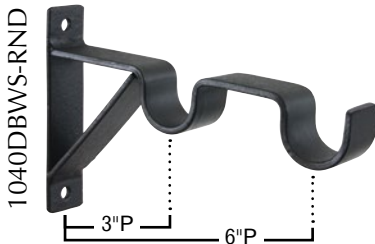
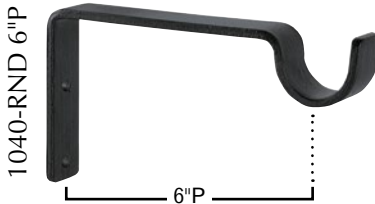

1016 Baton
with Clip
Length: 48"
Diameter: 1/2"



Our most popular Iron Art™, Bohemia, and Italian finials with expedited shipping.

Two finish collections determine the shipping speed. Express It! finishes are shipped the next business day while Quicken It! finishes are shipped within 3 business days. Choose from eight finials in our Iron Art™ line, three finials in our Italian line, or nine Bohemia Crystal finials for either line. Complete your set with mounting hardware, rings, and accessories!

Bohemia Crystal Finials - All Bohemia Crystals available in XpressYourway Program, Popular Styles Shown Below.



787
 (3½" x 2")
 Shown in Brown (19)



775
 (2¾" x 2½")
 Shown in Pure White (33)



774
 (2" x 2¾")
 Shown in Polished Chrome (IT 206)



782 (New!)
 (2⅞" x 2¾")
 Shown In Antique Bronze (02)



790
 (¾" x 2")
 Shown in New Nickel (12)



788
 (3½" x 2")
 Shown in Black (14)



778
 (1¼" x 2⅜")
 Shown in Brushed Nickel (IT 201)



781 (New!)
 (2⅛" x 2⅜")
 Shown In Antique Gold (06)



772 (New!)
 (2¾" x 2⅜")
 Shown In Soft Pewter (13)

Ordering Information:

1. All orders received by 12:00 noon Pacific time are considered same day orders. Shipping times are in business days.
2. Finials are interior fit only.
3. Modifications from specifications offered will not qualify for the Xpress Yourway program.
4. Cancellation of orders will result in a 35% restocking fee.
5. Please utilize the Xpress Yourway order form or mark orders as Xpress Yourway.
Orders without an Xpress Yourway indication will be processed with standard shipping times.
6. Xpress Yourway Wall Display is available. Please see item #8002 on page 79.

Italian Line - 1" round rod only, three finials, and two finishes. Coordinate with accessories, brackets, and rings.

Express It! Finishes
Next Day Shipping



Mounting Brackets

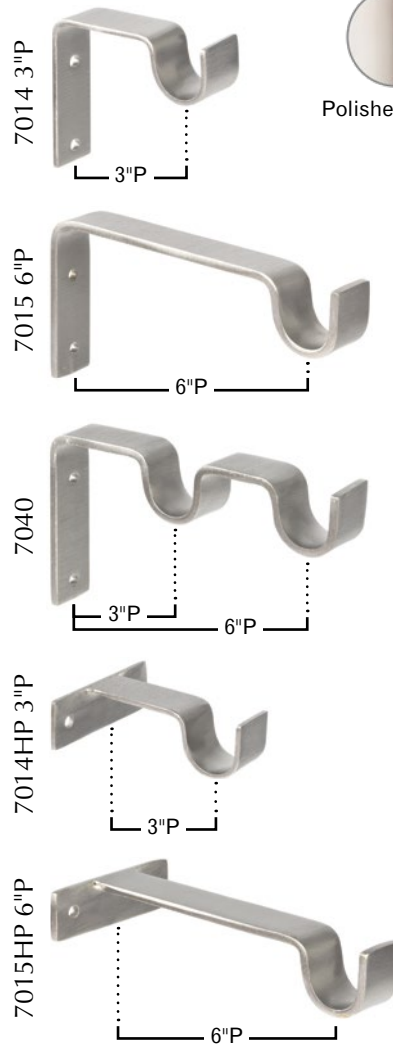

7013
Ring with Eyelet

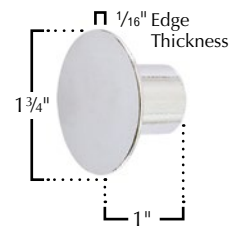

7016
Metal End Cap

1014 Baton
with Clip
Length: 48"
Diameter: 1/2"



7003
(2" x 2")

7005
(2" x 1 1/8")

7006
(2" x 1")



New Finial Designs

15 New Styles



Finial 550
6 $\frac{3}{8}$ " Long x 4" High x $\frac{3}{4}$ " Deep
Shown in Rich Gold (07) on a 1" round rod.



Finial 551
3 $\frac{7}{8}$ " Long x 3 $\frac{7}{8}$ " High x $\frac{5}{8}$ " Deep
Shown in Burnt Gold (25) on a 1" round rod.



Finial 552
4 $\frac{1}{4}$ " Long x 4 $\frac{1}{4}$ " High x 1" Deep
Shown in Soft Pewter (13) on a 1 $\frac{1}{4}$ " fluted rod.



Finial 553
4" Long x 4" High x 3 $\frac{1}{4}$ " Deep
Shown in Antique Bronze (02) on a 1 $\frac{1}{4}$ " twist rod.

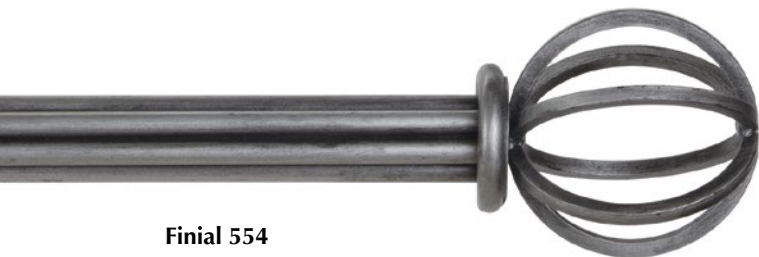

Finial 554
3 $\frac{5}{8}$ " Long x 3 $\frac{5}{8}$ " High x 3 $\frac{5}{8}$ " Deep
Shown in Soft Pewter (13) on a 1 $\frac{1}{4}$ " fluted rod.



New Finial Designs

15 New Styles



Finial 555
 6⁷/₈" Long x 6³/₈" High x 1" Deep - 1¹/₂" at base
 Shown in *Black (14)* on a 1¹/₂" square rod.



Finial 9704
 2" Long x 1¹/₂" High x 1¹/₂" Deep
 Shown in *Brown (19)* on a 3/4" square rod.



Finial 556
 6³/₈" Long x 2¹/₈" High x 1¹/₂" Deep - 1³/₈" at base
 Shown in *Naturelle (03)* on a 3/4" rope rod.



Finial 9705
 2" Long x 1¹/₈" High x 1¹/₈" Deep
 Shown in *Light Brown (09)* on a 3/4" round rod.



Finial 557
 6" Long x 1⁵/₈" High x 1¹/₄" Deep - 1¹/₄" at base
 Shown in *Naturelle (03)* on a 3/4" rope rod.



Finial 9705L
 3" Long x 1³/₄" High x 1³/₄" Deep
 Shown in *Antique Gold (06)* on a 1¹/₄" round rod.



Finial 558
 2" Long x 2⁵/₈" High x 2⁵/₈" Deep - 1³/₄" at base
 Shown in *New Nickel (12)* on a 1" square rod.



Finial 9706
 2" Long x 1" High x 1" Deep
 Shown in *Black (14)* on a 3/4" square rod.



Finial 559
 1¹/₈" Long x 2¹/₄" High x 2¹/₄" Deep
 Shown in *Bronze Vecchio (15)*
 on a 1" hammered twist rod.



Finial 9706L
 3" Long x 1³/₄" High x 1³/₄" Deep
 Shown in *Antique Copper (10)*
 on a 1¹/₂" square rod.

Finials

All finials are available as interior or exterior fit. If not specified, interior fit is provided. Finials shown in Naturelle finish.

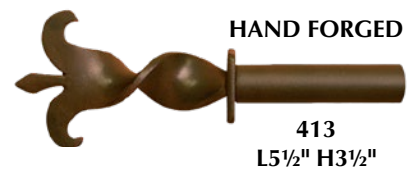
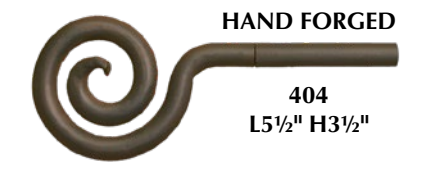
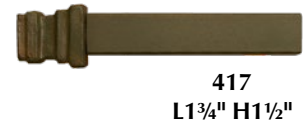
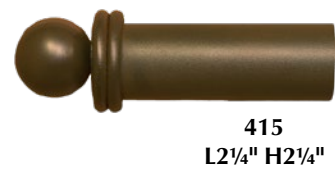

Finials

Finials shown in Naturelle finish.



421
L6½" H3¼"



Only available as shown.
422
L3½" H5¾"



501
L6" H6"



502
L4" H4"



503
L8" H4"



505
L2¾" H1½"

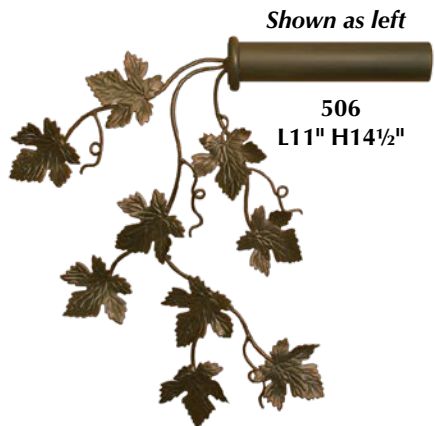

Shown as left
506
L11" H14½"



Shown as left
507
L9¼" H8¼"



508
L6¾" H8"



509
L9½" H8"



510
L5½" H9¾"



511
L1" H2"



512
L1¾" H2¼"



513
L1" H2¼"



HAND FORGED
Shown as left
707
L6½" H5¾"



Shown as left
711
L9¼" H9½"

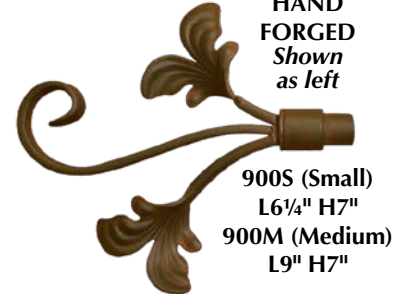

HAND FORGED
Shown as left
900S (Small)
L6¼" H7"
900M (Medium)
L9" H7"



901
L7½" H3¾"



902
L7¾" H4¼"



903
L5½" H4"



904S (Small)
L6" H2¾"



904L (Large)
L9" H4¼"

...to enhance your home!

Finials

Finials shown in Naturelle finish.



905
L5" H2¼"



912
L6¼" H1½"



Shown
as left

929
L5" H3"



906S (Small)
L3½" H3"



913S (Small)
L3¾" H3"



Movable
Finial

Shown
as left

929MV
L5" H3"



906L (Large)
L5" H4¾"



913L (Large)
L4" H3¾"



Only
available
as shown

933
L4½" H2½"

HAND FORGED



907
L5¼" H3¾"

HAND FORGED

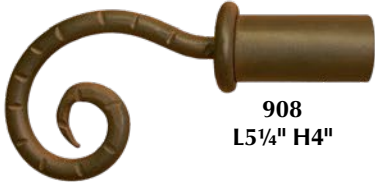

908
L5¼" H4"



914
L4" H3"



934
L7¾" H2¾"



909
L8" H2½"



916
L2" H1½"



935
L9" H5"

HAND FORGED



910
L5½" H5"



921
L5¼" H3½"

HAND FORGED
Shown as left



936
L6¾" H3¾"



911
L5½" H2¾"



Shown as left

927
L4¼" H4¾"

HAND FORGED
Shown as left



937
L10½" H5½"

Finials

Finials shown in Naturelle finish.

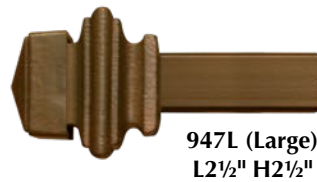
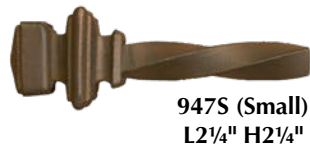
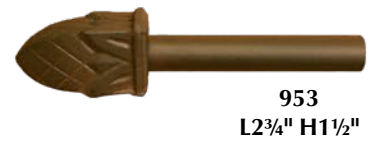
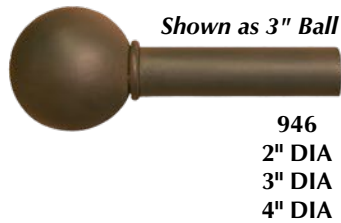

..just let your imagination take over!

Finials

Finials shown in Naturelle finish.

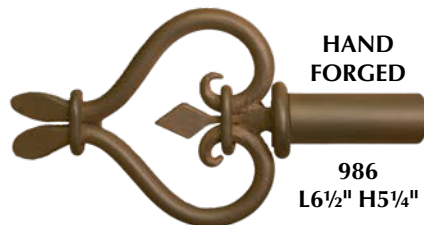
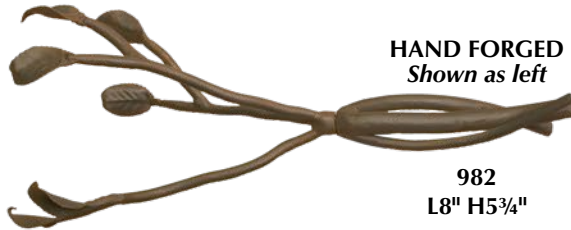

Village Forge Collection

Hand Crafted Iron Finials

All finials shown as left.



Finial: 600
Finish: Autumn
L7 1/2" H9"



Finial: 604
Finish: Burnt Silver
L7 1/2" H2 3/4"



Finial: 601
Finish: Rich Gold
L8 1/2" H6"



Finial: 605
Finish: Antique White
L6 1/2" H6"

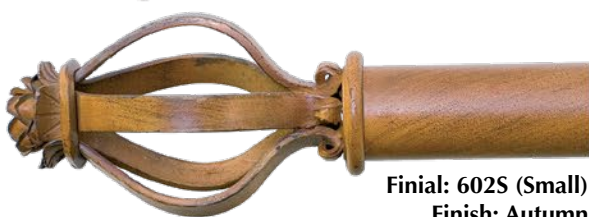

Finial: 602S (Small)
Finish: Autumn
L5 3/4" H3 1/8"



Finial: 606
Finish: Bronze Vecchio
L8 1/4" H7 1/4"



Finial: 602L (Large)
Finish: Burnt Silver
L7" H4 1/4"



Finial: 607
Finish: Cherry Gold
L9" H4 3/4"



Finial: 603
Finish: Antique Copper
L8 1/2" H8"



Finial: 608
Finish: Cherry Gold
L6" H6"

Journey into Wrought Iron Craftsmanship.

Provence Collection

Decorative Hand Blown Art Glass Finials

DISCONTINUED.



Finial: 830
L4½" H3"
Rod Finish:
Brushed Nickel



Finial: 833
L4½" H3"
Rod Finish:
Antique Gold



Finial: 836
L3¼" H3¼"
Rod Finish:
Antique Copper



Finial: 831
L4½" H3"
Rod Finish:
Rich Gold



Finial: 834
L4½" H3"
Rod Finish:
Brushed Nickel



Finial: 837
L3¼" H3¼"
Rod Finish:
Antique Bronze



Finial: 832
L4½" H3"
Rod Finish:
Antique Copper



Finial: 835
L3¼" H3¼"
Rod Finish:
Black



Finial: 838
L3¼" H3¼"
Rod Finish:
Polished Chrome

Eclectic Collection

DISCONTINUED.



801
L4½" H2¾"



802
L5½" H3½"

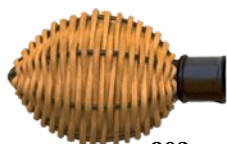

803
L4½" H3"

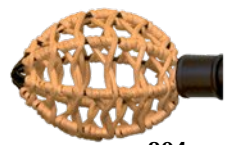

804
L4½" H3"



805
2¾" DIA



806
L3" H2½"



807
L4¾" H2¾"



808
L4¾" H2¾"



Available
in Italian
Connectors
only

809
L6¼" H3¼"



Available
in finish as
shown only

810
L5¼" H5¼"



Available
in finish as
shown only

811
L5¼" H5¼"

Iron Art Accessories



313 KNOB
H1" 1/4" Thick



314 HOOK
P1 1/2"
Available in
specified size only.



214 HOOK
L3" H1 3/4" P1 1/2"
Available in
specified size only.

Available in
specified size only.



311
HOOK BRACKET
P3"



310
HOOK PEG
L2 3/4" H3 1/2"



316S (Small)
3" to 5" ID
3/8" Thick



316L (Large)
6" to 12" ID
1/2" Thick

RING BRACKETS

Specify Inner
Diameter when
ordering.

SOCKETS



302



303



308
DECORATIVE
SOCKET
L5" H2"

END CAPS



301 CAP
Interior Fitting



321
DECORATIVE
END CAP
Interior Fitting



307
MITER
PER CUT

309 Elbow with
interior fit required.

Angle can be modified.
Additional charges apply.

ELBOWS



309 ELBOW
Shown as 90° exterior fit.
Specify interior or
exterior fit, 45° or 90°.



315
MOVABLE ELBOW
Interior Fitting



312
CORNER BRACKET
3" TO 4 1/2" P
Exterior fit only.
Specify 45° or 90°.



320
MOVABLE
CORNER BRACKET
3" TO 4 1/2" P
Interior Fitting



300 CONNECTOR

Rods

Rings are not included. Please order separately. Additional charges for threading the rods apply.

ROUND HOLLOW ROD



ROUND HOLLOW HAMMERED ROD



ROUND SOLID ROD



ROUND SOLID HAMMERED ROD



TWIST HOLLOW ROD



TWIST HOLLOW HAMMERED ROD



SQUARE HOLLOW ROD



SQUARE HOLLOW HAMMERED ROD



ROPE ROD



WOOD GRAIN SOLID ROD



FLUTED ROD Only available as 1 1/4" OD



ROD WITH RETURN #264



Rod with Returns: Standard P3" or P6" in Round or Square rods and sockets available in Round, Square or Vertical Back Plates. Please refer to page 32 and 33 of IA Price List for line drawings

Brackets

We recommend brackets at a distance of every 48" for normal use.
Please see the Bracket Guide on page 18 of the Price List for sizes.



1010-RND
P3"



1028-RND
P6"

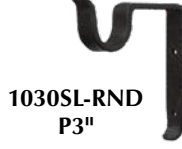

1030SL-RND
P3"



1040HD-RND
P3"



1011-RND
P3" H3"



1028HP-RND
P3"

Top Weld Standard.
Center Weld Available on Request.
Also Available in HD (Heavy Duty).



1033-RND
P3"



1040DBWS-RND
P3" & P6"



1021S-RND
P1½"



1028EXP-RND
P3" - 4¼"



1034-RND
P3"



1040EBP-RND
P3"



1021-RND
P3"



1028HD-RND
P3"

Ceiling Mount Bracket

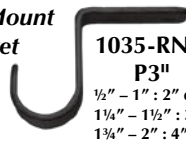

1035-RND
P3"

½" - 1" : 2" drop x 2" Proj.
1¼" - 1½" : 3" drop x 2" Proj.
1¾" - 2" : 4" drop x 2" Proj.



1040HP-RND
P3"

Top Weld Standard.
Center Weld Available on Request.
Also Available in HD (Heavy Duty).



1024DBWS-RND
P3" & P6"



1028WS-RND
P3"

Double Ceiling Mount Bracket



1036-RND
P3" & P6"



1040WS-RND
P3"

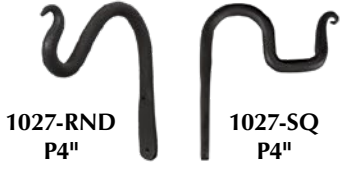

1027-RND
P4"

1027-SQ
P4"



1028EBP-RND
P3"



1038-RND
P4"



1040EXP-RND
P3" - 4¼"



1028-RND
P3"



1029-RND
P4"



1040-RND
P3"



1028-SQ
P3"



1030-RND
P3"



1040-SQ
P3"



1046-RND
FOR ½"-1" RODS
P1½"

Decorative Brackets



1100
L3½" H3¾"
Shown as Right



1102
L2¼" H4"



1103
L3" H2¾"



1104
L2½" H8"



1105
L4½" H2½"



1106
L5" H3"
Shown as Left

Rings

Eyelets can be modified as per drawing, additional charges apply. Please see the Ring Guide on page 20 of the Price List for sizes. We recommend the inner diameter of the ring to be 1/2" LARGER than rod diameter. Rings are 1/4" thick. Bypass system "C" Rings available on page 24.



350 ROUND RING 351 TWISTED RING 352 SQUARE RING 353 FORGED RING 354 HOOK RING 355 ROUND RING WITH CLIP 356 ROUND HAMMERED RING

Swing Arms

Measurements are based from the end of the back plate to the outer tip of the finial.

1074 1/2" ROUND & 1074A 3/4" ROUND, 1/2" PROJECTION
Mounting Plate Style R1: L1" H4"
H = 5" (height above the rod)

1075 3/4" ROUND, 1/2" PROJECTION
Mounting Plate Style R1: L1" H4"
Minimum Length: 18"

1090 5/8" TWIST HOLLOW, 1/2" PROJECTION
Mounting Plate Style D3: L3" H3"

1091 3/4" ROUND, 1/2" PROJECTION
Mounting Plate Style R2: L2" H4"
Minimum Length: 36", Shown as Right
H = 6 1/2" (height above the rod)

1092 3/4" ROUND, 1/2" PROJECTION
Mounting Plate Style R2: L2" H4"
Minimum Length: 18"
H = 6 1/2" (height above the rod)

1093 1" ROUND, 1/2" PROJECTION
Mounting Plate Style R2: L2" H4", Shown as Right
Movable Finial (#929MV) at Additional Charge

HAND FORGED

1094 1/2" SQUARE SOLID, 1/2" PROJECTION
Shown with welded eyelets (#317) equally spaced.
Mounting Plate Style R1: L1" H4"

1097 P3" H5"
Mounting Plate P3"

1098 P6" H5"
Mounting Plate P6"

1099 SUPPORT BRACKET
1/2", P3" & P6"

Distinctive styling, solid craftsmanship!

Tiebacks/Swag Holders

Tiebacks/Swag Holders are available as Expandable Post Projection, Fixed Post Projection, or "U" Shape Bend. Additional charges will apply for any modification. When ordering, please specify the tieback style. If not specified, the style shown in the catalog will be sent.

"U" Shape Bend
shown as right



715
L8½" H4"



1005
2¾" DIA



1032
L4½" H6¼"



1060
ROSETTE
3¾" DIA

"U" Shape Bend
shown as right



716
L8½" H5¾"



1006
L9" H4¼"

Only available as
"U" Shape Bend



Shown
as right

1037
L8" H6"



1061
ROSETTE
4½" DIA



Post Tieback
shown as left

929TB
L5" H3"



1007
L12½" H4¾"

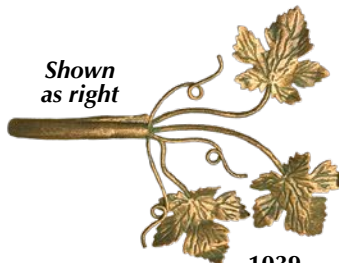

Shown
as right

1039
L9¾" H8"



1063
POPPY
2¾" DIA

Only
available
as shown



933TB
L4½" H2½"



1008
L13¼" H5¼"



1064
FLEUR DE LIS
L4¾" H5¾"



977
HORSESHOE
L4¾" H5¼"



1013
L8" H1"



1057
L10" H7¾"



1065
MOON
L4" H4½"
Only
available
as shown



1003
L4¾" H4¾"



1026
L3" H6"



1058*
ROSETTE
3" DIA

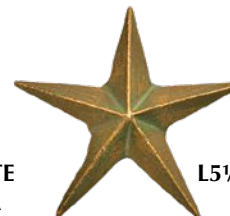

1066
STAR
L5¼" H5¼"



1004
L4¾" H5"



1031*
3½" DIA



1059*
ROSETTE
3" DIA



1067
LION
L4½" H5½"

Tiebacks/Swag Holders

Tiebacks/Swag Holders are available as Expandable Post Projection, Fixed Post Projection, or "U" Shape Bend.
Additional charges will apply for any modification. When ordering, please specify the tieback style.
If not specified, the style shown in the catalog will be sent.



1068
OAK
L7½" H3¾"
Post Tieback
shown as left



1073
3½" DIA

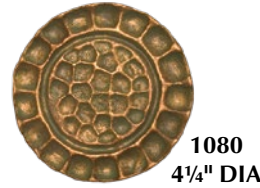

1080
4¼" DIA

Flush Mount Swags



1085
L3" H6¼"



Front View



Side View

1086
3" DIA

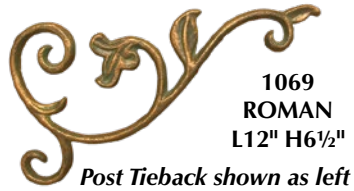

1069
ROMAN
L12" H6½"

Post Tieback shown as left



1076
L3" H4¾"



1081
L7" H6½"
Only
available
as shown



Post Tieback
shown as left

1070
ROSE
L8" H4¼"



1077
L3" H6¼"



1082
L2½" H6¾"



1071
SWIVEL TIEBACK
L6¾" H11"
HAND FORGED



1078
3¾" DIA



1083
L4" H4¼"



1088 POST PROJECTION
BACK PLATE
Expandable from 3" to 4½"
Mounting Plate is 2"



1088FX POST PROJECTION
BACK PLATE
Fixed Projections in
3", 4" or 6½"
Includes Mounting Plate

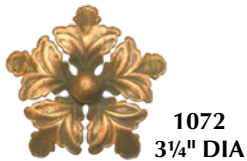

1072
3¼" DIA



1079
6¼" DIA



1084
L3½" H9"

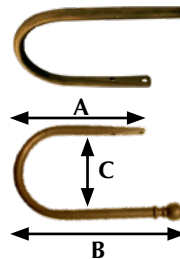

1087
"U" SHAPE BEND
Projection 3½"

2087 "U" SHAPE BEND
WITH BALL FINIAL
Projection 3½"
(A=4 ½", B=8 ½" including
finial, C=3 ½")

Batons

Specify Ring or Clip

Available with or
without eyelet.

1015

1016

1017

Available with or
without eyelet.

1018

1019

1020

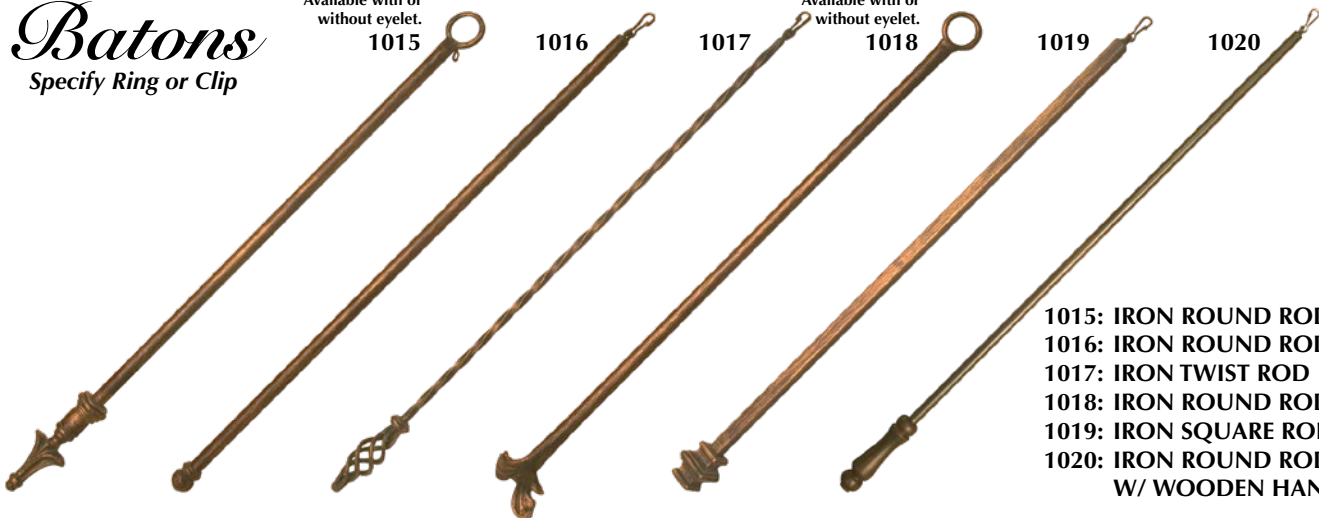

- 1015: IRON ROUND ROD ½" DIA
- 1016: IRON ROUND ROD ½" DIA
- 1017: IRON TWIST ROD ¼" DIA
- 1018: IRON ROUND ROD ½" DIA
- 1019: IRON SQUARE ROD ½" DIA
- 1020: IRON ROUND ROD ½" DIA
W/ WOODEN HANDLE

...for a complete, coordinated look!

Unique Collection

Bypass System with "C" Rings

Available in 3/4" diameter and above. Straight Round Hollow Rods only.
Available in all Iron Art™ and Italian Collection finishes. Shown in Soft Pewter.

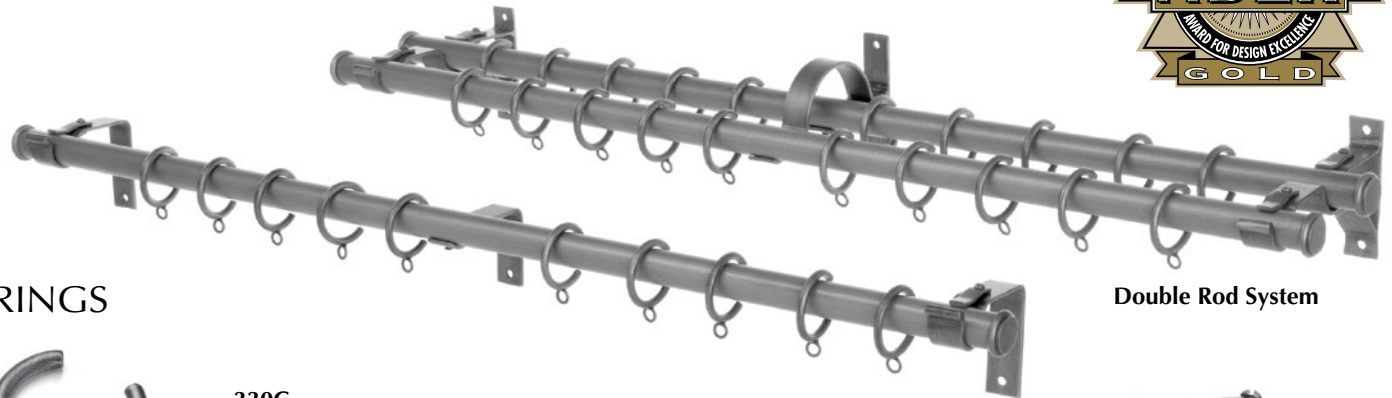

RINGS



330C
"C" RING

Single Rod System

Double Rod System



Side View

1045

Top View

BRACKETS



1028SE
3" P SINGLE
END BRACKET



1028SE
6" P SINGLE
END BRACKET



1024DE
3" & 6" P
DOUBLE END
BRACKET



318SC
3" P SINGLE
SUPPORT
BRACKET



318SC
6" P SINGLE
SUPPORT
BRACKET



319DC
3" & 6" P
DOUBLE
SUPPORT
BRACKET

Horizontal Plate Bottom Weld
is available (318SC-HP-3"P)

Horizontal Plate Bottom Weld
is available (318SC-HP-6"P)

Oasis Collection

Expandable Sets

Rod diameter is a combination of 1" & 7/8"



913 ES
L3 3/4" H3"



946 ES
2" DIA



916 ES
L2" H1 1/2"



956 ES
L6 1/4" H4 1/4"

Sets are available as:		
Small	27"-48"	2 Brackets
Medium	45"-82"	3 Brackets
Large	81"-118"	3 Brackets
Extra Large	117"-154"	4 Brackets
All sets include Rods, Finials, and Brackets.		

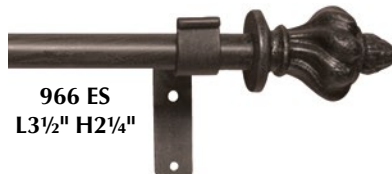

966 ES
L3 1/2" H2 1/4"

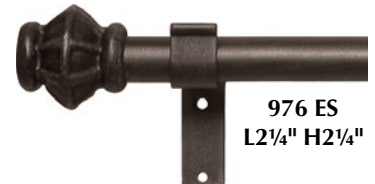

976 ES
L2 1/4" H2 1/4"

Milano Collection

Roman Shades on Drapery Hardware

Shown as assembled set. Available as round 5/8" diameter rod only. Available While Supplies Last.

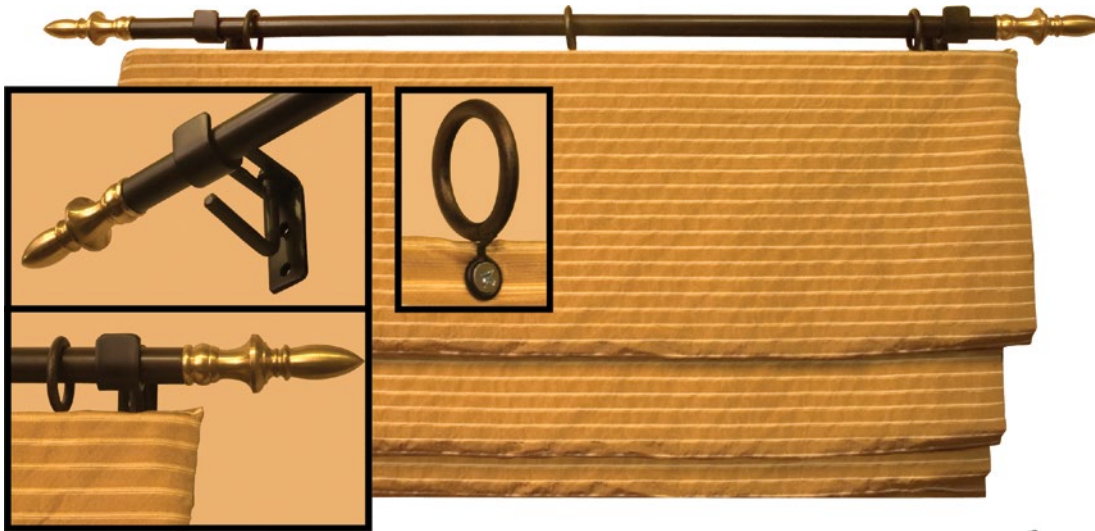

Fina Collection

Thin Line Drapery Hardware

Available for ½" rod diameter only. Finials as exterior fit only. Rod and rings not included.

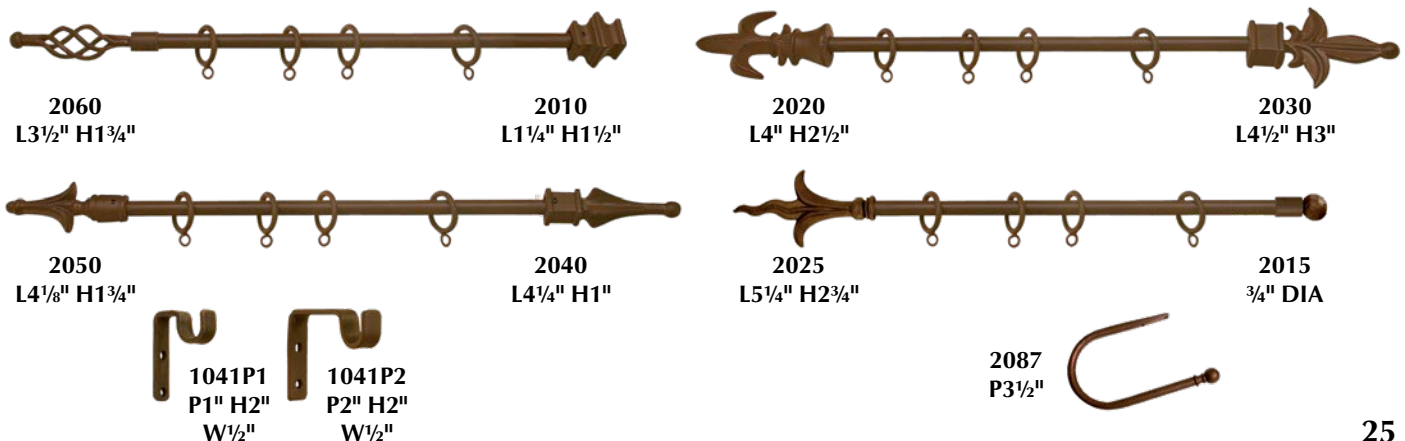

3D Drapery Hardware

Finials in Front of Rod



Explore new window designs with the ability to have the finial in front of the rod. Finials can also be manually adjusted to be above or below the rod simply by changing their position to enhance the window covering presentation.

Combined with our master carriers, which help reduce light gaps, this system is also great for tight areas where you may not be able to fit the finial you would like to use when using conventional drapery hardware.

Nearly all our finials are available for use with the 3D system (some exceptions are listed on page 27). Rods are 1" diameter in either round hollow smooth (Iron and Italian) or hammered styles (Iron only). Choose from 35 Iron Art™ finishes, 5 Italian finishes, or your own custom finish.

3D Drapery Hardware

Finials in Front of Rod

3D Drapery Hardware can be used with single or double rod systems. Back rods in the double rod system are the same length as the front rod, including their end caps. Straight master carriers allow the drapery to pass the end brackets, giving you maximum window coverage. Begin your order by selecting your 3D Drapery Hardware Kit from the selections below.

3D Drapery Hardware Kits:

3D Single Kit:

- Two 180° U-Bends for one iron rod.
- Two straight master carriers for rings.
- Four rings (two for each straight carrier).

3D Double Kit:

- Two 180° U-Bends for one iron rod.
- Four straight master carriers for rings.
- Eight rings (two for each straight carrier).
- Two end caps for one back rod.

Description	Item #
3D Single Kit for Iron Art Finishes	3D-SIA
3D Single Kit for Italian Finishes	3D-SIT

Description	Item #
3D Double Kit for Iron Art Finishes	3D-DIA
3D Double Kit for Italian Finishes	3D-DIT

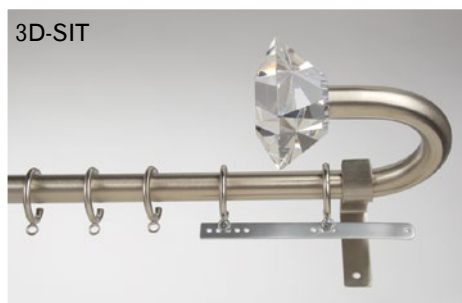

Kit images shown with additional rings.

Drapery Hardware:

1" Round Hollow Rods

- Available in 35 Iron Art™ finishes, 5 Italian finishes, or your own custom finish.
- May be used with Bypass Rings.

1" Round Hollow Hammered Rods

- Available in 35 Iron Art™ finishes, or your own custom finish.
- **Not for use with Bypass Rings.**

Finials

- Choose from almost any Iron Art™ finial, all Italian finials, and all Bohemia Crystal finials. (See exceptions listed under Finials.)

Brackets

- Brackets ordered for use with the 3D system include lids and set screws to keep rods secure.

Rings

- Choose from any style of ring.

Overlap Master Carrier Set (optional):

- Works with center open draperies and rings for complete drapery closure in the front.

Finishes:

Iron Art™ drapery hardware is available in 35 Iron Art™ finishes, or your own custom finish. Italian drapery hardware is available in five Italian finishes: Brushed Nickel, Black Nickel, Oiled Bronze, Satin Copper, and Satin Gold. *Polished Chrome is not available for 3D Drapery Hardware.*

Rods:

Choose from 1" diameter round hollow rods in smooth or hammered styles. Order by your rod length tip to tip. (See measurement guidelines on page 29.)

Iron Art Rods	Italian Rods
Description	Description
1" Diameter Round Hollow Rod	1" Diameter Round Hollow Rod
1" Diameter Round Hollow Hammered Rod	

Finials:

Because of their size and branch shape, we don't recommend the 3D system for use with Iron Art™ finials 410, 416, 506, 711, 939, 954, 979, and 982, and Village Forge finials 600, 601, 603, and 606. All other Iron Art™ finials, Italian finials, and Bohemia Crystal finials may be utilized.

3D Drapery Hardware

Position the U-Bends from horizontal to vertical, and anything in between, with the use of our brackets with lids and set screws.



Brackets:

Choose from any of our Iron Art™ brackets. We will add lids and set screws to keep your rods secure, allowing you to position the 3D rod at various angles.

Rings:

Choose from any of our Iron Art™ rings. 3D Kits and Overlap Master Carrier Sets will come with two matching rings for each carrier.

Bypass System:

3D Drapery Hardware using smooth rods can be utilized with our Unique Collection support brackets and "C" Rings for one way draw.



Single rod system shown with one way draw in Italian finish Brushed Nickel.



Double rod system shown with one way draw in Iron Art™ finish Soft Pewter.

3D Drapery Hardware

Finials in Front of Rod

Overlap Master Carrier Set (optional):

This set works with center open draperies and rings for complete drapery closure.

Description	Item #
Overlap Master Carrier Set in Iron Art Finishes	MCS-IA
Overlap Master Carrier Set in Italian Finishes	MCS-IT

What's Included:

- One straight master carrier for rings.
- One overlap master carrier for rings.
- Four rings (two for each carrier).



Overlap Master Carrier Set with Rings.



Overlap Top View.



Single hammered rod system shown as center open in Iron Art™ finish black.

Measurement Guidelines:

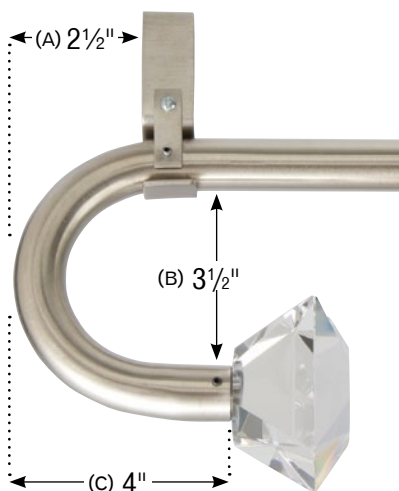

- A) The distance from the end of the straight rod to the edge of the curve is 2½".
- B) The U-Bend projection is 3½".
- C) The front face of the U-Bend is 4" long, not including the finial.
- D) **Order your rod length tip to tip.**
- E) Available in 1" diameter round hollow smooth or hammered styles, single or double rod systems. Back rods in the double rod system are the same length as the front rod, including their end caps.



3D Drapery Panels

Finials and Stationary Panels in Front of Rod



Introducing our latest product addition, 3D Drapery Panels. Similar to our 3D Drapery Hardware, 3D Drapery Panels allow you to have the finial in front of the rod, perfect for tight spaces. But now the wrap around front portion of the rod can be used for stationary panels. Just give us the length up to 24" on each side.

Specially designed brackets provide support for the front panel rods. Bypass rings for the functional drapery behind the panels allow the curtain to pass under the support brackets.

Available for 1" smooth round hollow rods in 35 Iron Art™ finishes, 5 Italian finishes, or your own custom finish.



3D319DC Bracket

3D Drapery Panels

3D Drapery Panel Kits Include:

- Two 180° U-Bends for One Iron Rod
- Two Front Panel Rod Extensions Up To 24" Long
- Two 3D319DC Support Brackets
- Two Straight Master Carriers for Rings
- Four Bypass "C" Rings (Two for Each Straight Carrier)

Description	Item #
3D Panel Kit for Iron Art Finishes	3D-PIA
3D Panel Kit for Italian Finishes	3D-PIT

Order Along With:

1" Smooth Round Hollow Rods

- Available in 35 Iron Art™ finishes, your own custom finish, or five Italian finishes: Brushed Nickel, Black Nickel, Oiled Bronze, Satin Copper, and Satin Gold. *Polished Chrome is not available for 3D Drapery Hardware.*



Bypass "C" Ring

Finials

- Choose from almost any Iron Art™ finial, all Italian finials, and all Bohemia Crystal finials. Because of their size and branch shape, we don't recommend the 3D system for use with Iron Art™ finials 410, 416, 506, 711, 939, 954, 979, and 982, and Village Forge finials 600, 601, 603, and 606.

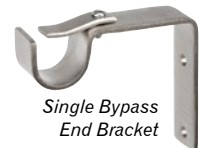

Single Bypass End Bracket

Rings

- Choose from any style of ring for the front panels.
- Use Unique Collection Bypass "C" Rings for functional rear draperies (330C or 7330C).



Single Bypass Support Bracket
Horizontal Plate Bottom Weld is available (318SC-HP-3"P)

Additional Brackets

- Use Unique Collection Single Bypass End Brackets (1028SE or 7014SE).
- Use Unique Collection Single Bypass Support Brackets for additional support (318SC or 7318SC).

Optional Hardware:

Overlap Master Carrier Set

- Works with center open draperies and rings for complete drapery closure in the front (MCS-IA or MCS-IT).



Overlap Master Carrier Set with Rings.

Batons

- Easily open and close draperies while minimizing handling to keep them clean (1015-1020 or 1014).

Measurement Guidelines:

- Order your rod length tip to tip.
- Order your front panel rod extension length up to 24".
- The U-Bend projection is 3½".
- Two Straight Master Carriers and four Bypass "C" Rings are included in the set.
- Two 3D319DC Support Brackets are included in the set.

Order These in Addition to the Kit:

- 1" diameter Smooth Round Hollow Rod
- Finials
- Rings for front panel
- Unique Collection Bypass "C" Rings for rear draperies (330C or 7330C)
- Unique Collection Bypass End Brackets (1028SE or 7014SE)
- Optional Overlap Master Carrier Set

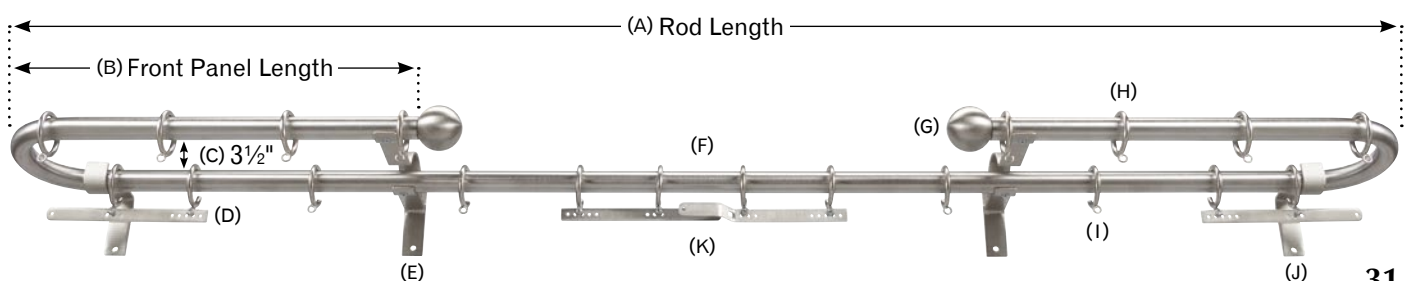

Tropical Collection

Faux Bamboo on Iron

Finials

Available While Supplies Last.



Side View

9000
PALM LEAF
L5¼" H9"

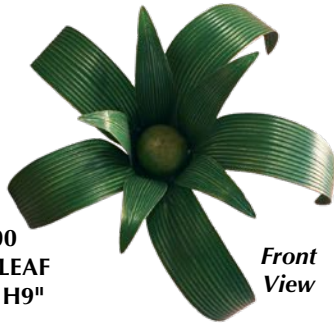

Front View



Side View

9003
SHELL
L5¾" H4"



Top View



Side View

9001
BAMBOO
LEAVES
L6½" H7"

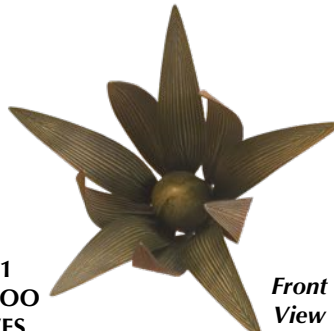

Front View



Side View

9004
BAMBOO CAP
L¾" H2"

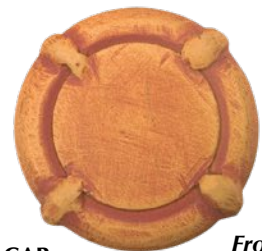

Front View



Side View

9002
COCONUT
L7¼" H5"

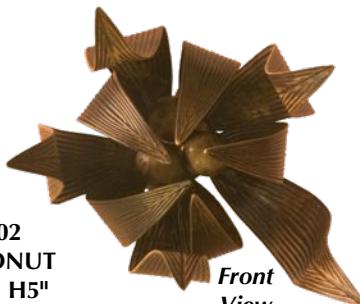

Front View

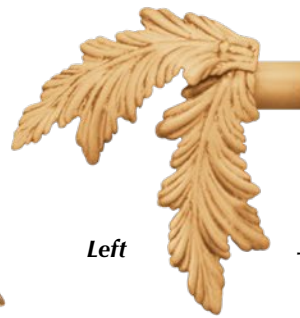

Left

9005
TROPICAL
ACCENT
L5¾" H6"

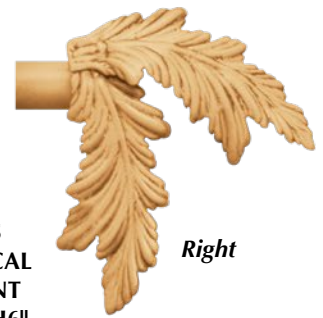

Right

Decorative Cornices

Optional Wood Duster available. Refer to Product #8046 and #8047 (Tuscany Collection) in Price List

Front View



Detail View



9040
(Shown as H3½")
Also Available as 9040D (H5½")

MOTORIZATION &
CORD DRAWN TRACKS
AVAILABLE!
Call for Quote

Tropical Collection

Faux Bamboo on Iron

Rods

Available While Supplies Last.



9020 3/4", 1", 1 1/4", 1 1/2", AND 2" DIAMETER STRAIGHT RODS



9020BT 3/4", 1", 1 1/4", 1 1/2", AND 2" DIAMETER BENT RODS



9022 3/4", 1", 1 1/4", 1 1/2", AND 2" DIAMETER DECORATIVE RODS

Swing Arms

Measurements are based from the end of the back plate to the outer tip of the finial.

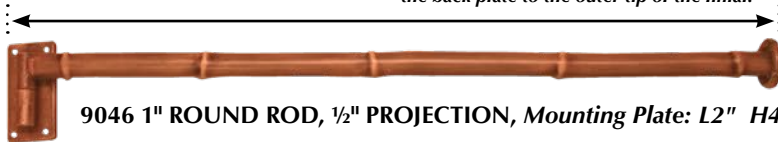

9046 1" ROUND ROD, 1/2" PROJECTION, Mounting Plate: L2" H4"

Tiebacks



9060
P3 1/2"

1263 P3"
Single Traverse /
Rod Combination

Brackets

9010 P3"



9011 P6"



9012 P3" & P6"

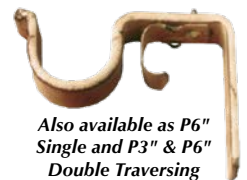

Also available as P6"
Single and P3" & P6"
Double Traversing
Brackets



Baton
Specify Ring
or Clip

9050
5/8" DIA
Available in
38" Long Only

Rings



9025
ROUND
5/8" THICK



9029
FLAT
3/4" WIDE



8006
TROPICAL FINISH
SELECTOR SET

Finishes

Also available in
High Gloss Finishes.
Please add 20%
upcharge.



TC201
YELLOW TIGER



TC202
BLACK TIMOR



TC203
NATURAL BROWN



TC204
RED BAMBUSSA



TC205
GREEN CANE



TC206
RUSTIC BAMBOO

...in your home!

Burgundy Collection

Hand Crafted Decorative Rods



251 VINEYARD H3½"



251B (BENT)
VINEYARD H3½"
Curve as per template



252 SOLID BRANCH, Approx. H3"



253 SOLID SNAKE, ⅝" DIA, Approx. H2"



254 ROUND WRAPPED
WITH GRAPEVINE LEAVES
¾" Shown, Approx. H10"



254B (BENT) ROUND WRAPPED WITH GRAPEVINE LEAVES
¾" Shown, Approx. H10"
Curve as per template

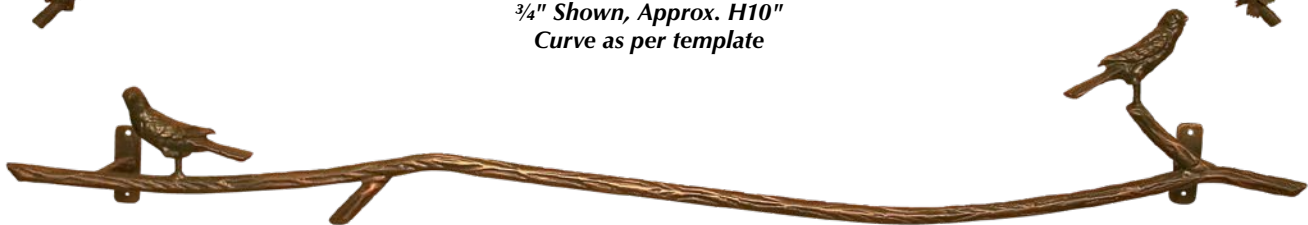

255 WOODGRAIN, ⅝" Solid or ⅞" Solid Only, P3" Brackets Included, Birds (#929) at Additional Charge, Approx. H9"



256 GRAPEVINE CURVED
¼" Solid, P3" Brackets Included
Approx. H8"

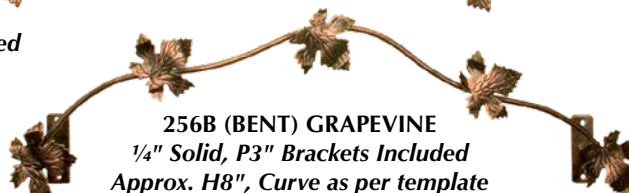

256B (BENT) GRAPEVINE
¼" Solid, P3" Brackets Included
Approx. H8", Curve as per template

¾" to 2" Round Hollow Rods are included in the price for #254 and #254B. Order brackets separately for #252, #253, #254, and #255B.

Burgundy Collection

Hand Crafted Decorative Rods

264 ROD WITH RETURN



Rod with Returns: Standard P3" or P6" in Round or Square rods and sockets available in Round, Square or Vertical Back Plates. Please refer to page 32 and 33 of IA Price List for line drawings

Measurements are based from the outside of the left socket to the outside of the right socket.



264D
DECORATIVE ROD WITH RETURN
Shown as 1 1/2" Dia, Approx. H10"



257 ROSEVINE LEAVES
1/4" Solid, P3" Brackets Included Approx. H6"

A template, as applicable must be provided for production purposes.



257B (BENT) ROSEVINE LEAVES
1/4" Solid, P3" Brackets Included
Approx. H6"



L=78" 280 ROMAN, Overall Length 78", Approx. H7 1/2" Above the Rod, Standard P3" or P6" Available



L=52" 281 ROMAN, Overall Length 52", Approx. H7 1/2" Above the Rod, Standard P3" or P6" Available



L=78" 282 SPANISH, Overall Length 78", Approx. H7 1/2" Above the Rod, Standard P3" or P6" Available



L=52" 283 SPANISH, Overall Length 52", Approx. H7 1/2" Above the Rod, Standard P3" or P6" Available



284 TWINE BRANCH
Available in Any Length
Approx. 5 1/2" Above the Rod without Birds
Standard P3" or P6" Available
Birds (#929) and Finials (#954) at Additional Charge



285 TWINE BRANCH
Available in Any Length, Approx. 5 1/2" Above
the Rod without Birds, Shown as Bypass System
Standard P3" or P6" Available
Birds (#929) and Finials (#954) at Additional Charge

3/4" to 2" Round Hollow Rods are included in the price for #264, #264D, #280, #281, #282, #283, #284, and #285. Order finials and rings separately.

...vineyards, glades and forests!

Mediterranean Collection

Lightweight Decorative Crowns

Mounting options include Flush, Wood Duster Bracket and Wall Bracket P3"

4001 SERVENA
L38" H15"



4002 CASTILLA
L30" H13"



4003 CAMILLA
L33½" H8¾"



4004 SOFIA
L28¼" H4"



4005 MALLORCA
L29½" H14¾"



4006 VALENCIA
L29½" H11"



4007 MINERVA
L22" H10"



4008 ISABELLE
L37½" H19½"



4009 ASHA
L27" H14"



4010 SEVILLE
L26½" H15½"



4011 MORNING GLORY
L45½" H12½"

Vienna Collection

Decorative Scrolls

All measurements
are from tip to tip.

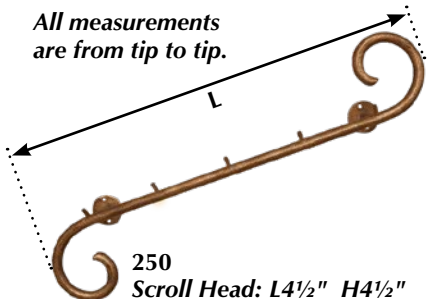

250
Scroll Head: L4½" H4½"
⅝" Solid, Min. Length 16"
Shown as left.
Knobs on front side.



266
Bottom Scroll Head: L7½" H7"
Top Scroll Head: L2½" H3½"
Min. Length 17", Max. Length 48"
Shown as left. Knobs on back side.



267
Scroll Head: L7½" H7"
Min. Length 27", Max. Length 48"
Shown as left. Knobs on back side.



268
Scroll Head: L5½" H6½"
⅝" Solid, Min. Length 16"
Shown as left.
Knobs on front side.



270
Scroll Head: H5½"
⅝" Solid, Min. Length 16"
Knobs on front side.



269
Scroll Head: L4½" H6½"
⅝" Solid, Min. Length 16"
Shown as right.
Knobs on front side.

Renaissance Collection

Lightweight Decorative Cornices

9125 CATHEDRAL L26½" H10" PER PANEL (Shown with 3 panels)



9126 PONTALBA L25¼" H8½" PER PANEL (Shown with 3 panels)



9127 NEW ORLEANS L27½" H8½" PER PANEL (Shown with 3 panels)



9128 GOTHIC L27¾" H11" PER PANEL (Shown with 3 panels)

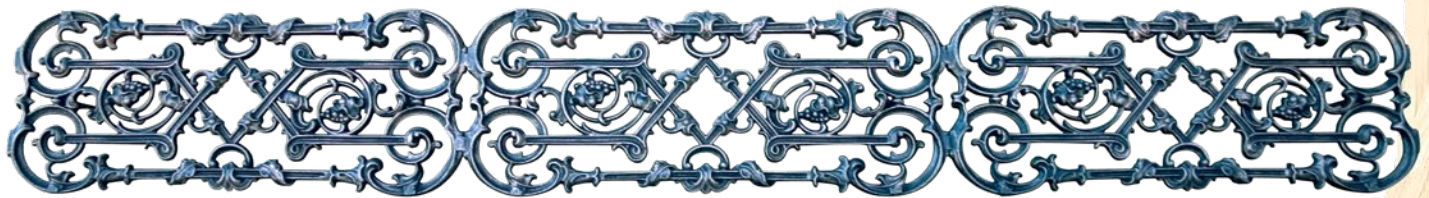

9129 FLORENCE L27¼" H11¼" PER PANEL (Shown with 3 panels)



9130
RETURNS WITH
MOUNTING
PLATES UP TO 6"



Decorative Cornice shown with
6" returns and mounting plates.
(Shown with 1 panel)

... classy and timeless!

Tuscany Collection
Lightweight Decorative Metal Cornices
Available While Supplies Last.



Tuscany Collection

Lightweight Decorative Metal Cornices

Available While Supplies Last.

NARROW (27/8" - 33/4")

8021 ACANTHUS SINGLE H 3 1/2" (Shown in Bronze Vecchio)

8022 ACANTHUS DOUBLE H 7"



8023 TULIP SINGLE H 3 1/2" (Shown in Cherry Gold)

8024 TULIP DOUBLE H 7"



8034 SPRING LEAF SINGLE H 3 3/4" (Shown in Gold Antique White)

8035 SPRING LEAF DOUBLE H 7 1/2"



8026 BAROQUE SINGLE H 3 3/8" (Shown in Rusty)

8027 BAROQUE DOUBLE H 6 3/4"



8036 SEA SHORE SINGLE H 3 3/4" (Shown in Cherry Gold)



8028 EMBOSSED SINGLE H 2 7/8" (Shown in Antique Bronze)

8029 EMBOSSED DOUBLE H 5 3/4"



8055 INFINITE GEOMETRY SINGLE H 3 5/8" (Shown in Antique Gold)

8056 INFINITE GEOMETRY DOUBLE H 7 1/4"



8030 BUD BRANCH SINGLE H 3 1/2" (Shown in Antique Gold)

8031 BUD BRANCH DOUBLE H 7"



8057 CLASSIC SINGLE H 3 1/2" (Shown in Burnt Gold)

8058 CLASSIC DOUBLE H 7"



8032 SPANISH SCROLL SINGLE H 3 1/2" (Shown in Antique Bronze)

8033 SPANISH SCROLL DOUBLE H 7"



8059 ROYAL ROAD SINGLE H 3 1/2" (Shown in Autumn)

8060 ROYAL ROAD DOUBLE H 7"

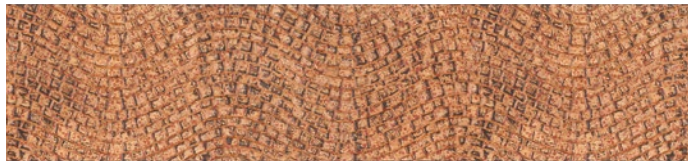

Tuscany Collection

Lightweight Decorative Metal Cornices

Available While Supplies Last.

MEDIUM (4" - 5½")

8037 BASKET WEAVE H 5½" (Shown in Rich Gold)

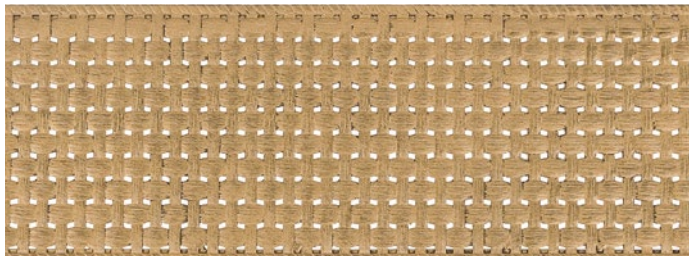

8067 OLIVE BRANCHES SINGLE H 4¾" (Shown in Antique Copper)

8068 OLIVE BRANCHES DOUBLE H 8¾"



8061 BAMBOO DELIGHT SINGLE H 4⅞" (Shown in Bronze Patina)

8062 BAMBOO DELIGHT DOUBLE H 8¼"



8069 EMBLEM SINGLE H 4¼" (Shown in Sage Gold)

8070 EMBLEM DOUBLE H 8¼"



8063 Sunbursts SINGLE H 4⅞" (Shown in Antique Bronze)

8064 SUNBURSTS DOUBLE H 8¼"



8071 SWIRLS SINGLE H 4⅞" (Shown in Antique White)

8072 SWIRLS DOUBLE H 8¼"



8065 METAL WEAVE SINGLE H 4⅞" (Shown in Soft Pewter)

8066 METAL WEAVE DOUBLE H 8¼"

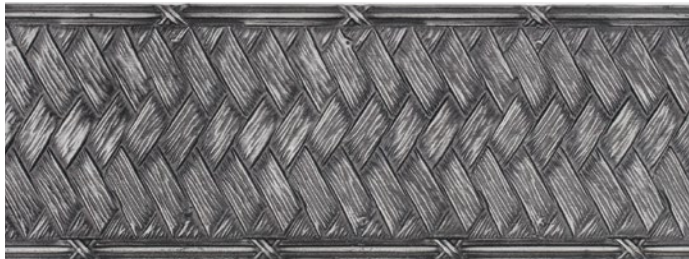

8073 Windblown SINGLE H 4" (Shown in Antique Copper)

8074 Windblown DOUBLE H 8"



Tuscany Collection

Lightweight Decorative Metal Cornices

Available While Supplies Last.

TALL (6" - 8")

8025 HAMMERED SINGLE H 8" (Shown in Soft Pewter)

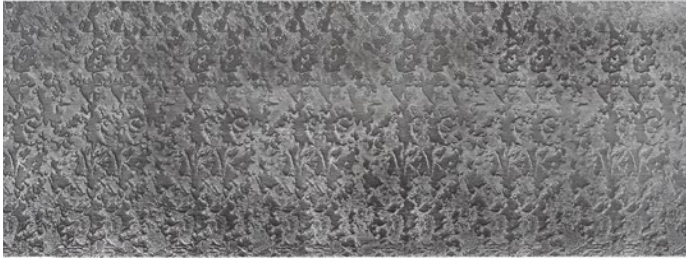

8077 LATTICE WEAVE H 6 1/8" (Shown in Bronze Vecchio)



8075 PYRAMIDS H 6" (Shown in Vecchio Patina)



8079 MOSAICS H 6" (Shown in Versace)



CORNICE OPTIONS



All Designs can be bent (8044)

Manual and Motorized Traversing



Orion's traversing systems come with many great features, plus plenty of options to choose from.

When using traversing, draperies will open and close easier than traditional rod and ring combinations through the use of heavy-duty glides, tracks and pulleys. With these heavy-duty systems you can safely hang up to 62 pounds of drapes on a 16 foot track; great in these days of lining and interlining. Single or double track systems up to 30 feet in length allow for a wide range of drapery styles. Front tracks are available with or without rings.

Our cord or baton drawn traversing collections include Designers' Choice (Iron, Wood, and Italian fascia styles), Tuscany Traversing (lightweight embossed metal rods), and Deco Lite Traversing (lightweight embossed metal panels). All these collections can be motorized with Somfy.

Orion offers nearly 200 different finials and 52 beautiful finishes to compliment your traversing system. You can even do your own custom finish. With so many options to choose from, you're sure to create that perfect design!

DESIGNERS' CHOICE TRAVERSING RODS

Single and Double Traversing Sets
in Iron, Italian, and Wood Fascia Styles.

Iron and Italian - pages 44-45
Wood - pages 72-73

TUSCANY TRAVERSING

Single and Double Traversing Sets with
Lightweight Embossed Metal Rod Designs.

Available While Supplies Last.

pages 46-48

TRAVERSING ACCESSORIES

Rings, Batons, Glides, Etc.

page 49

Manual and Motorized Traversing

DECO LITE TRAVERSING

Single and Double Traversing Sets with
Lightweight Embossed Metal Panel Designs.

Available While Supplies Last.

pages 50-51

TRAVERSING WITH
SOMFY MOTORIZATION
Motorization for Traversing Collections.

pages 52-55

SOMFY ACCESSORIES
Control Options, Rings, Glides, Etc.

pages 56-57



Designers' Choice Traversing Rods

SAMPLE SINGLE CONFIGURATIONS

Available in 1½" and 2" diameters.

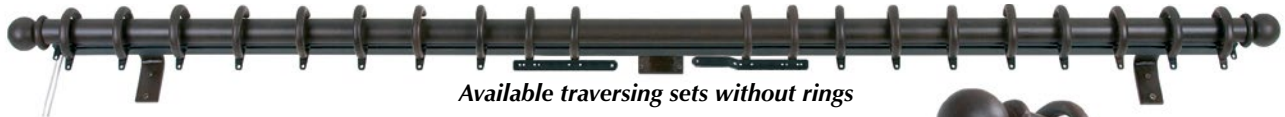

Available traversing sets without rings



Shown:
Finial: 946-Small 2" Diameter
Rod: 1½" Round Traversing Rod
Ring: IT350TR - Smooth Ring
Set Finish: Rusty
Track Finish: Black
Draw Opening: Center Open
 Available in Iron Art™ or Italian Collection Finishes.



Set: ITRR-S

Also available in 3" diameter



Available traversing sets without rings



Shown:
Finial: 947L
Rod: 2" Square Traversing Rod
Ring: IT352TR - Square Ring
Set Finish: Soft Pewter
Track Finish: Black
Draw Opening: Center Open
 Available in Iron Art™ or Italian Collection Finishes.



Set: ITSQ-S



Available traversing sets without rings



Shown:
Finial: 946H-Medium 3" Diameter
Rod: 2" Round Hammered Traversing Rod
Ring: IT356TR - Hammered Ring
Set Finish: Bronze Patina
Track Finish: Antique Bronze
Draw Opening: Center Open



Set: ITRH-S

Also available in 3" diameter



Shown:
Finial: 906S
Rod: 1½" Fluted Traversing Rod
Set Finish: Vecchio Patina
Track Finish: Antique Bronze
Draw Opening: Right Stack



Set: ITFL-S

Automatically includes heavy duty track at no extra charge. Finials, rings, and batons sold separately. Glides are available in white, black, antique bronze or gold. • All end pulleys are available only in white. All traversing tracks can be mitered, Round and Round Hammered only can be Bent or Curve.

Designers' Choice Traversing Rods

SAMPLE DOUBLE CONFIGURATIONS

Available: Front Rod in 1½" and 2" diameters. Back Rod in 1¼" diameter only.



Available traversing sets without rings



Shown:
 Finial: 946-Large 4" Diameter
 Front Rod: 3" Round Traversing Rod
 Back Rod: Track Only
 Ring: IT350TR - Smooth Ring
 Set Finish: Rich Gold
 Track Finish: Gold
 Draw Opening: Right Stack
 Available in Iron Art™ or Italian Collection Finishes.

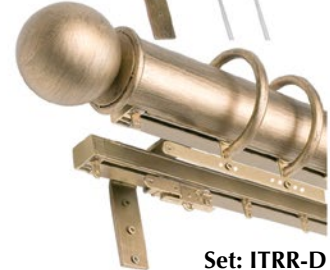

Set: ITRR-D

Also available in 3" diameter



Available traversing sets without rings



Shown:
 Finial: 7006L
 Front Rod: 2" Square Traversing Rod
 Back Rod: 1¼" Square Traversing Rod
 Ring: IC352TR - Square Ring
 Set Finish: Brushed Nickel
 Track Finish: White
 Draw Opening: Center Open
 Available in Iron Art™ or Italian Collection Finishes.



Set: ICSQ-D

*Italian Collection Iron Traversing Set



Available traversing sets without rings



Shown:
 Finial: 908
 Front Rod: 2" Round Hammered Traversing Rod
 Back Rod: 1¼" Round Hammered Traversing Rod
 Ring: IT356TR - Hammered Ring
 Set Finish: Burnt Gold
 Track Finish: Antique Bronze
 Draw Opening: Center Open

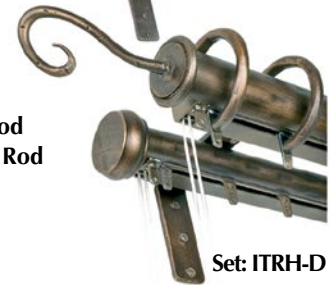

Set: ITRH-D

Also available in 3" diameter



Shown:
 Finial: 903
 Front Rod: 2" Fluted Traversing Rod
 Back Rod: 1¼" Fluted Traversing Rod
 Set Finish: Cherry Gold
 Track Finish: Gold
 Draw Opening: Left Stack



Set: ITFL-D

Automatically includes heavy duty track at no extra charge. Finials, rings, and batons sold separately. Glides are available in white, black, antique bronze or gold. • All end pulleys are available only in white. All traversing tracks can be mitered, Round and Round Hammered only can be Bent or Curve.

Tuscany Traversing Collection

Lightweight Embossed Metal Rods

Available While Supplies Last.

SAMPLE MANUAL CONFIGURATIONS: CORDED



SINGLE TUSCANY TRAVERSING

Finial: 947

Set Finish: Antique Copper

Rod Fascia Design: TT8055 Infinite Geometry

Draw Opening: Right Stack



SINGLE TUSCANY TRAVERSING WITH RINGS

Finial: 903

Set Finish: Antique White

Rod Fascia Design: TT8023 Tulip

Draw Opening: Right Stack



DOUBLE TUSCANY TRAVERSING

Finial: 414

Set Finish: Antique Bronze

Rod Fascia Design: TT8021 Acanthus

Draw Opening: Center Open



DOUBLE TUSCANY TRAVERSING WITH RINGS

Finial: 418

Set Finish: Bronze Patina

Rod Fascia Design: TT8034 Spring Leaf

Draw Opening: Center Open



Tuscany Traversing Collection

Lightweight Embossed Metal Rods

Available While Supplies Last.

FASCIA DESIGNS

TT8021 ACANTHUS H 2½" (Shown in Bronze Vecchio)



TT8023 TULIP H 2½" (Shown in Cherry Gold)



TT8034 SPRING LEAF H 2¾" (Shown in Gold Antique White)



TT8026 BAROQUE H 2¾" (Shown in Rusty)



TT8036 SEA SHORE H 2¾" (Shown in Cherry Gold)



TT8028 EMBOSSSED H 1⅞" (Shown in Antique Bronze)



TT8055 INFINITE GEOMETRY H 2⅝" (Shown in Antique Gold)



TT8030 BUD BRANCH H 2½" (Shown in Antique Gold)



TT8057 CLASSIC H 2½" (Shown in Burnt Gold)



TT8032 SPANISH SCROLL H 2½" (Shown in Antique Bronze)



TT8059 ROYAL ROAD H 2½" (Shown in Autumn)

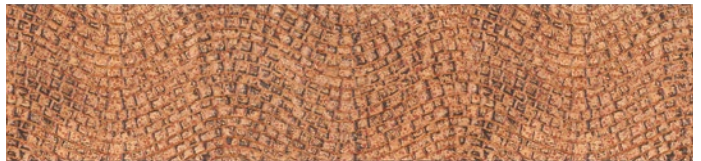

Tuscany Traversing Collection

Lightweight Embossed Metal Rods

Available While Supplies Last.

SAMPLE MOTORIZED CONFIGURATIONS



SINGLE TUSCANY TRAVERSING WITH SOMFY MOTORIZATION

Finial: 414

Rod Fascia Design: TT8021 Acanthus

Set Finish: Antique Bronze

Draw Opening: Center Open

TUSCANY TRAVERSING OPTIONS

TRACK SYSTEMS

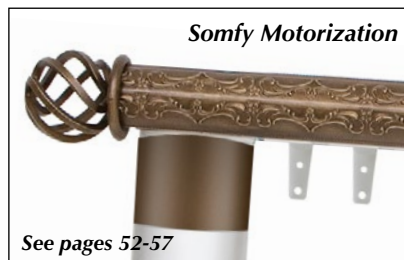
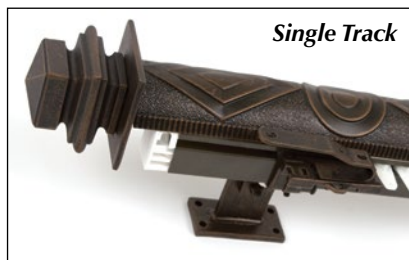

RING OPTIONS



BENT OPTION *(Rod may be bent or curved.)*



Traversing Accessories

WALL MOUNT End Brackets



1048EBS
SINGLE
END BRACKET
Vertical back plate

1049EBD
DOUBLE
END BRACKET
Vertical back plate

HEAVY DUTY BRACKETS WALL MOUNT Support Brackets



1050SBS
SINGLE SUPPORT
BRACKET
Horizontal back plate

1051SBD
DOUBLE SUPPORT
BRACKET
Horizontal back plate

CEILING MOUNT End & Support Brackets



1052CBS
SINGLE BRACKET
Horizontal top plate

1053CBD
DOUBLE BRACKET
Horizontal top plate

TRACKS AVAILABLE IN:



ANTIQUE
BRONZE

BLACK

GOLD

SILVER

WHITE

BATONS



IT1016BT
IRON BATON
1/2" DIA.
Available from
48" - 72"

IT1020BT
IRON BATON
WITH WOODEN
HANDLE
1/2" DIA.
Available from
48" - 72"

PINCH PLEAT GLIDES FOR SYSTEMS USING RINGS



PINCH PLEAT GLIDES FOR SYSTEMS WITHOUT RINGS



Available in white color only

TRAVERSING CLIPS *For spliced facia*



ROUND

SQUARE

RIPPLEFOLD GLIDES

Available in white color only



"C" RINGS

IRON

ITALIAN

WOOD



IT350TR **IT352TR** **IT356TR** **IC350TR** **IC352TR** **WT5047TR** **WT5049TR**
ROUND SQUARE HAMMERED ROUND SQUARE SMOOTH FLUTED

Deco Lite Traversing

Lightweight Embossed Metal Panels

Available While Supplies Last.

SAMPLE MANUAL CONFIGURATIONS: CORDED



SINGLE MANUAL TRAVERSING
Set Finish: Bronze Vecchio
Fascia Design: DT8021 Acanthus
Draw Opening: Right Stack



DOUBLE MANUAL TRAVERSING
Set Finish: Naturelle
Fascia Design: DT8055 Infinite Geometry
Draw Opening: Right Stack

SAMPLE MOTORIZED CONFIGURATIONS



SINGLE MOTORIZED TRAVERSING
Set Finish: Golden Oak
Fascia Design: DT8059 Royal Road
Draw Opening: Right Stack



DOUBLE MOTORIZED TRAVERSING
Set Finish: Antique Gold
Fascia Design: DT8034 Spring Leaf
Draw Opening: Right Stack



Deco Lite Traversing

Lightweight Embossed Metal Panels

Available While Supplies Last.

FASCIA DESIGNS

DT8021 ACANTHUS H 3½" (Shown in Bronze Vecchio)



DT8023 TULIP H 3½" (Shown in Cherry Gold)



DT8034 SPRING LEAF H 3¾" (Shown in Gold Antique White)



DT8026 BAROQUE H 3⅝" (Shown in Rusty)



DT8036 SEA SHORE H 3¾" (Shown in Cherry Gold)



DT8028 EMBOSSED H 2⅞" (Shown in Antique Bronze)



DT8055 INFINITE GEOMETRY H 3⅝" (Shown in Antique Gold)



DT8030 BUD BRANCH H 3½" (Shown in Antique Gold)



DT8057 CLASSIC H 3½" (Shown in Burnt Gold)



DT8032 SPANISH SCROLL H 3½" (Shown in Antique Bronze)



DT8059 ROYAL ROAD H 3½" (Shown in Autumn)

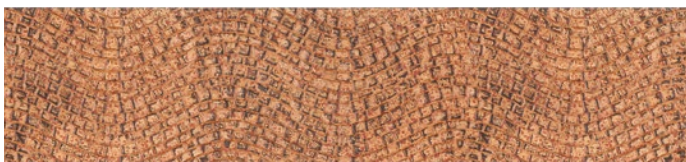

DECO LITE TRAVERSING OPTIONS

TRACK SYSTEMS

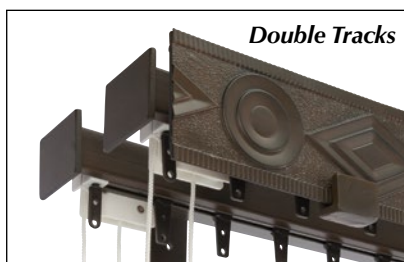

Traversing with Somfy Motorization



TRAVERSING WITH SOMFY
CHOOSE. TOUCH. RELAX.™

Traversing with Somfy Motorization



Available traversing sets without rings

DOUBLE IRON WITH RINGS

Set: STRR-D

Finial: 946

Set Finish: Old Black

Ring:

IT350TR - Round Traversing Ring

Rod Fascia Design: 1½" DIA. Round Traversing Rod

Draw Opening: Center Open



Available traversing sets without rings

DOUBLE ITALIAN WITH RINGS

Set: STIR-D

Finial: 946

Set Finish: Polished Chrome

Ring:

IT350TR - Round Traversing Ring

Rod Fascia Design: 1½" DIA. Round Traversing Rod

Draw Opening: Center Open



Available traversing sets without rings

SINGLE IRON WITH RINGS

Set: STRH-S

Finial: 946H

Set Finish: Naturelle

Ring:

IT356TR - Hammered Traversing Ring

Rod Fascia Design: 1½" DIA. Round Hammered Traversing Rod

Draw Opening: Center Open

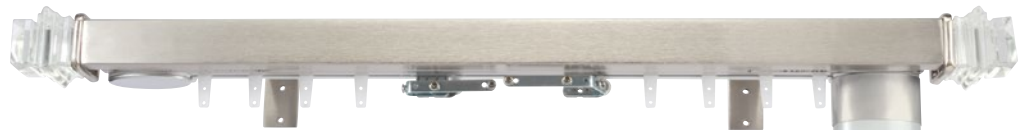

SINGLE ITALIAN WITHOUT RINGS

Set: STIQ-S

Finial: 782

Set Finish: Brushed Nickel

Rod Fascia Design: 2" DIA. Square Traversing Rod

Draw Opening: Center Open



SINGLE IRON WITHOUT RINGS

Set: STSQ-S

Finial: 947L

Set Finish: Oil Rubbed Bronze

Rod Fascia Design: 2" DIA. Square Traversing Rod

Draw Opening: Center Open

Traversing with Somfy Motorization



SINGLE WOOD WITHOUT RINGS

Set: STSM-S

Finial: 5028

Set Finish: Aged Pewter

Rod Fascia Design: 2 1/4" DIA. Smooth Traversing Rod

Draw Opening: Right Stack



DOUBLE WOOD WITHOUT RINGS

Set: STWF-D

Finial: 5024

Set Finish: Mahogany

Rod Fascia Design: 2 1/4" DIA. Fluted Traversing Rod

Draw Opening: Left Stack



SINGLE TUSCANY TRAVERSING WITHOUT RINGS *(Available While Supplies Last)*

Set: TTST-S

Finial: 906S

Set Finish: Burnt Gold

Rod Fascia Design: TT8028 Embossed

Draw Opening: Center Open



TUSCANY TRAVERSING CURVED ROD *(Available While Supplies Last)*

Set: TTST-S with curve *(Additional charges apply)*

Finial: 990

Set Finish: Golden Oak

Rod Fascia Design: TT8030 Bud Branch

Draw Opening: Center Open



TRACK ONLY

Set: ST35-S (for 35 RTS Motor) / ST60E-S (for 60e RTS Motor)

Draw Opening: Right Stack

Traversing with Somfy Motorization

TRAVERSING WITH SOMFY OPTIONS

FASCIA OPTIONS

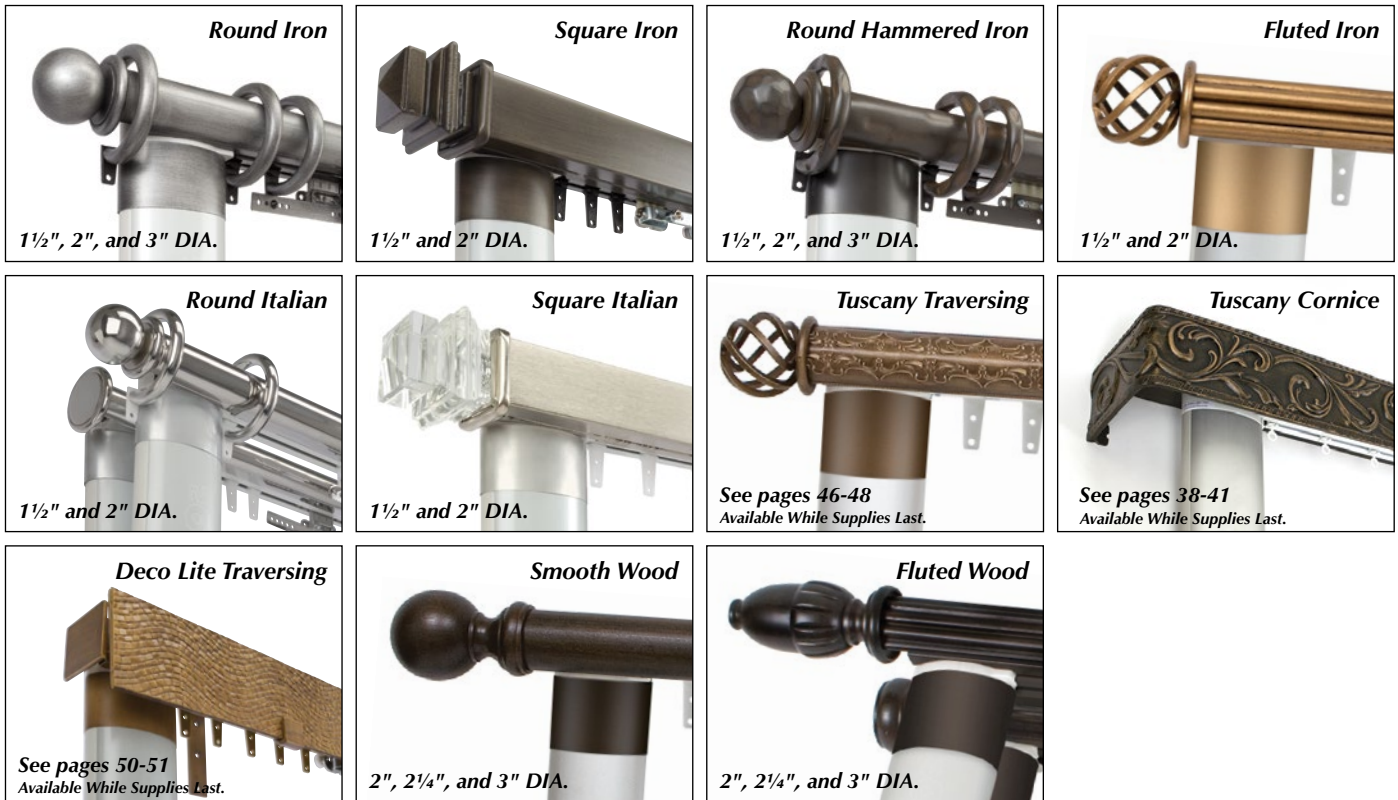

TRACK SYSTEMS



RING OPTIONS

ADDITIONAL INFORMATION

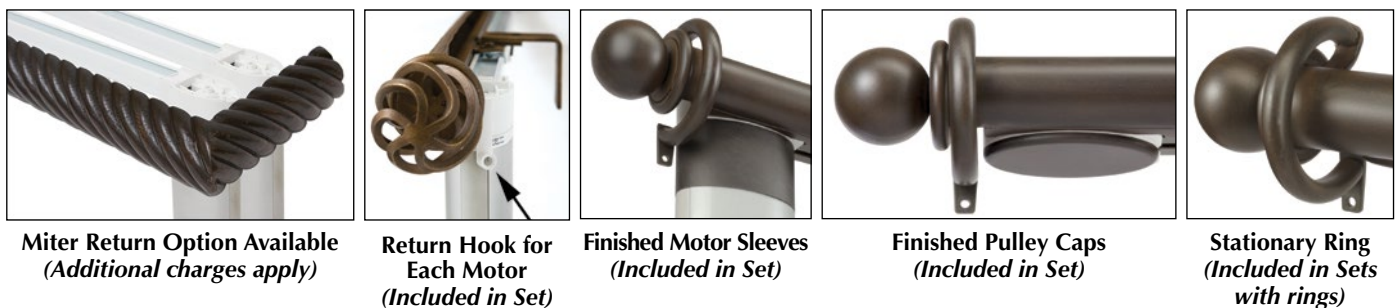

Traversing with Somfy Motorization

With Somfy's line of motors, simply press a button on your wireless wall switch, hand-held remote control, or the myLink™ App for your phone or tablet and your motorized curtains open smoothly and quietly.

MOTORS



**Glydea 60e
SMTR60E**

- Plugs Directly into Standard 110 V AC Duplex Wall Outlet (Comes with 10 Ft. Plug).
- Traverses up to 132 Lbs.

**Glydea 35e
SMTR35E**

- Plugs Directly into Standard 110 V AC Duplex Wall Outlet (Comes with 10 Ft. Plug).
- Traverses up to 77 Lbs.



**Irismo 35 Mini DC
SMTR35M**

- 24V DC Low Voltage Power Supply with 13.2 Ft. Cord.
- Traverses up to 77 Lbs.



**Irismo 45 WireFree
SMTR45M**

- Powered by a Rechargeable 26.5V Lithium Ion Battery.
- Extra Batteries Available. (SMTR45WBAT)
- Charger Sold Separately. (SMTR45WCHG)
- Traverses up to 99 Lbs.



CONTROL OPTIONS AND ACCESSORIES

DECOFLEX WIREFREE RTS WALL SWITCHES

White Finish



STSW1-WH
1 Track
1 Channel

STSW5-WH
1-5 Tracks
5 Channels

Ivory Finish



STSW1-IV
1 Track
1 Channel

STSW5-IV
1-5 Tracks
5 Channels

Black Finish



STSW1-BL
1 Track
1 Channel

STSW5-BL
1-5 Tracks
5 Channels

SOMFY SUNIS INDOOR (RTS) WIREFREE SENSORS



SUNIS-SUN
Sun Sensor Only
unlimited tracks
multi-channel



SUNIS-TMP
Sun & Temp. Sensor
unlimited tracks
multi-channel

TELIS 1 CHRONIS RTS

Silver Star Finish



STRP1-SS
1 Track / 1 Channel
Single Channel
Zone Control &
Programmable Timer

SITUO RTS REMOTE CONTROL

Pure Finish



STRP1-PR
1 Track
1 Channel

Silver Finish



STRP5-PR
1-5 Tracks
5 Channels

Silver Finish



STRP1-SL
1 Track
1 Channel

Lounge Finish



STRP5-SL
1-5 Tracks
5 Channels

Lounge Finish



STRP1-LO
1 Track
1 Channel

Lounge Finish



STRP5-LO
1-5 Tracks
5 Channels

SOMFY MYLINK™ RTS



STAPP
5 Channels
Control Somfy motors through a smart phone or tablet. Consists of a simple plug-in device and free app. Does not replace a preprogrammed RTS control.

DECOFLEX TABLE TOP ACCESSORIES



**Black Finish
STTABLE-BL**
with STSW1-BL

**Silver Finish
STTABLE-SL**
with STSW1-BL



Traversing with Somfy Motorization

HEAVY DUTY BRACKETS

WALL MOUNT End Brackets



1048EBSS
SINGLE
END BRACKET
Vertical back plate

1049EBSD
DOUBLE
END BRACKET
Vertical back plate

WALL MOUNT Support Brackets



1050SBSS
SINGLE SUPPORT
BRACKET
Horizontal back plate

1051BSD
DOUBLE SUPPORT
BRACKET
Horizontal back plate

CEILING MOUNT End & Support Brackets



1052CBSS
SINGLE BRACKET
Horizontal top plate

1053CBD
DOUBLE BRACKET
Horizontal top plate

TRACKS AVAILABLE IN:



ANTIQU
BRONZE

BLACK

GOLD

SILVER

WHITE

TRAVERSING CLIPS *For spliced facia*



ROUND

SQUARE

PINCH PLEAT GLIDES FOR SYSTEMS USING RINGS



PINCH PLEAT GLIDES FOR SYSTEMS WITHOUT RINGS



Available in white color only

RIPPLEFOLD GLIDES AND SNAP TAPE

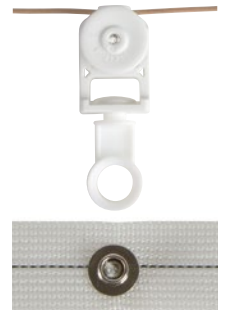

Available in white color only

"C" RINGS

IRON



IT350STR
ROUND

IT352STR
SQUARE

ITALIAN



IT356STR
HAMMERED

IC350STR
ROUND

IC352STR
SQUARE

WOOD



WT5047STR
SMOOTH

WT5049STR
FLUTED

Italian Collection

Metal Plated Iron Drapery Hardware

All Finials: Interior fit only. Available in 3/4", 1", and 1 1/4" diameter only.



Options
7002 1 1/2" DIA
7003* 2" DIA

Finial: 7002
Finish: Brushed Nickel

1 1/2" DIA



Finial: 7001
Finish: Brushed Nickel

L 1 3/4" H 1 1/4"



Options
7005 L 2" H 1 1/8"
7005L* L 3" H 1 3/4"

Finial: 7005
Finish: Brushed Nickel

L 2" H 1 1/8"



Finial: 7004
Finish: Polished Chrome

L 2" H 1 1/8"

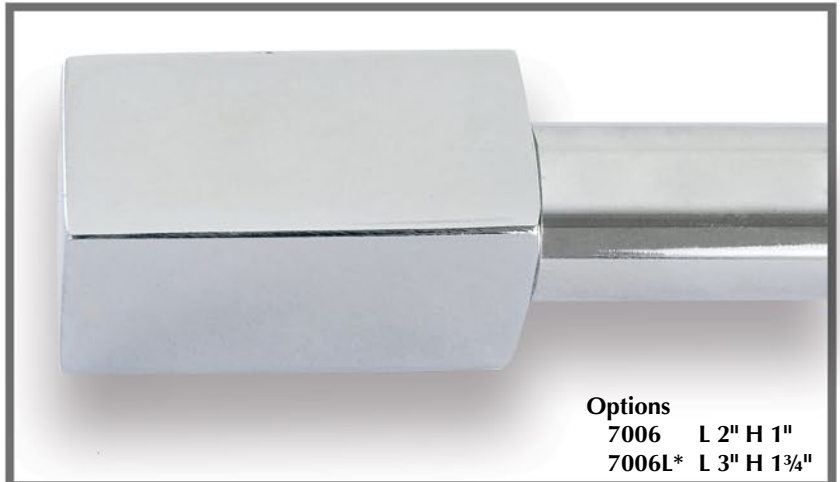

Options
7006 L 2" H 1"
7006L* L 3" H 1 3/4"

Finial: 7006
Finish: Polished Chrome

L 2" H 1"

New Finial Designs

3 New Designs for the Italian Collection

We've expanded our Italian Collection with three new finial designs for you to choose from. These modern styles combine the sleek sophistication of plated metal with the timelessness of wood. Finials are available in two different sizes. Choose from six Italian finishes for the metal and three wood finishes for the insert. Interior fit only. Available for 3/4", 1", and 1 1/4" diameter rods. Not available for Traversing Rods. Available While Supplies Last.



Finial 7070L
 3 3/4" Long x 1 3/8" High
 Shown in Polished Chrome (IT 206) on a 1" round rod with Walnut stained wood insert.



Finial 7070
 3 3/8" Long x 1" High
 Shown in Brushed Nickel (IT 201) on a 1" round rod with Oak stained wood insert.

Horizontal Lines



Finial 7071L
 3 3/4" Long x 1 3/8" High
 Shown in Polished Chrome (IT 206) on a 1" round rod with Natural stained wood insert.

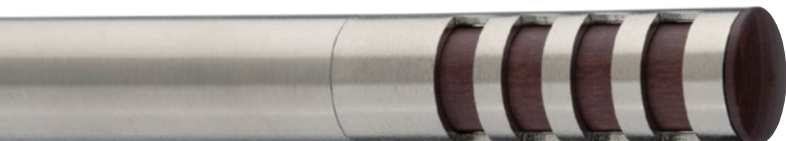

Finial 7071
 3 3/8" Long x 1" High
 Shown in Brushed Nickel (IT 201) on a 1" round rod with Walnut stained wood insert.

Slat Lines



Finial 7072L
 3 3/4" Long x 1 3/8" High
 Shown in Polished Chrome (IT 206) on a 1" round rod with Oak stained wood insert.



Finial 7072
 3 3/8" Long x 1" High
 Shown in Brushed Nickel (IT 201) on a 1" round rod with Natural stained wood insert.

Wavy Lines

AVAILABLE WOOD INSERT FINISHES



Natural



Oak



Walnut

Italian Collection

Metal Plated Iron Drapery Hardware



ROUND RODS

7019 3/4" DIA • 7020 1" DIA • 7023 1 1/4" DIA
(Shown in Brushed Nickel)

SQUARE RODS

7021 3/4" DIA • 7022 1" DIA • 7024 1 1/4" DIA
(Not Shown)



7321 END CAPS

(Left: Polished Chrome
Right: Brushed Nickel)
Available in Round only



7016 END CAPS

Available for Round or Square Rods
(Left: Brushed Nickel
Right: Polished Chrome)

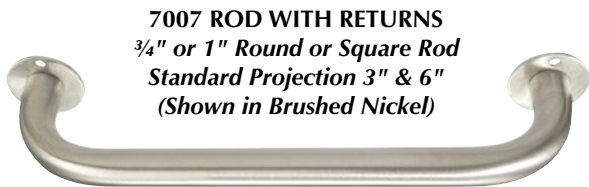

7007 ROD WITH RETURNS

3/4" or 1" Round or Square Rod
Standard Projection 3" & 6"
(Shown in Brushed Nickel)



7187

"U" SHAPE BEND
Projection 3 1/2"
(Shown in
Brushed Nickel)

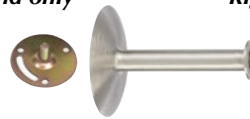

7188FX POST PROJECTION BACK PLATE

Fixed Projections in 3", 4" or 6 1/2"
Includes Mounting Plate
(Shown in Brushed Nickel)

1014
BATON
Specify Ring or Clip
(Shown in Polished
Chrome)



SINGLE 3"P BRACKETS - Available for Round or Square Rods



7014
END BRACKET
(Shown in
Polished Chrome)



7014HP
SUPPORT BRACKET
(Shown in Brushed Nickel)



7035
CEILING BRACKET
(Shown in Brushed Nickel)



7038
3"P EYELET BRACKET
(Shown in Brushed Nickel)
7039
6"P EYELET BRACKET
(Not Shown)



7012
(Shown in
Brushed Nickel)

SINGLE 6"P BRACKETS - Available for Round or Square Rods



7015
END BRACKET
(Shown in Polished Chrome)



7015HP
SUPPORT BRACKET
(Shown in Brushed Nickel)

SOCKETS
Available for Round
or Square Rods
(Shown in Polished
Chrome)



7013
(Shown in
Polished Chrome)

DOUBLE BRACKETS



7040
3" & 6"P DOUBLE BRACKET
Available for Round or Square Rods
(Shown in Polished Chrome)



7036
3" & 6"P DOUBLE CEILING BRACKET
(Shown in Brushed Nickel)

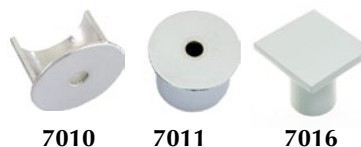

7010

7011

7016



45°



90°

7009

Available for Round or Square Rods
(Shown in Brushed Nickel)



7017

CORNER BRACKET
(Shown in Brushed Nickel)



7018

MOVABLE ELBOW
Shown in 3/4"; Interior Fit Only
(Shown in Polished Chrome)
Available with hinge, item # 7018-H,
similar to iron item #320 on page 19

Unique Collection: Italian Bypass System with "C" Rings

Available in 3/4", 1", and 1 1/4" diameters. Straight Round Hollow Rods only.
Available in all Iron Art™ and Italian Collection finishes. Shown in Brushed Nickel.

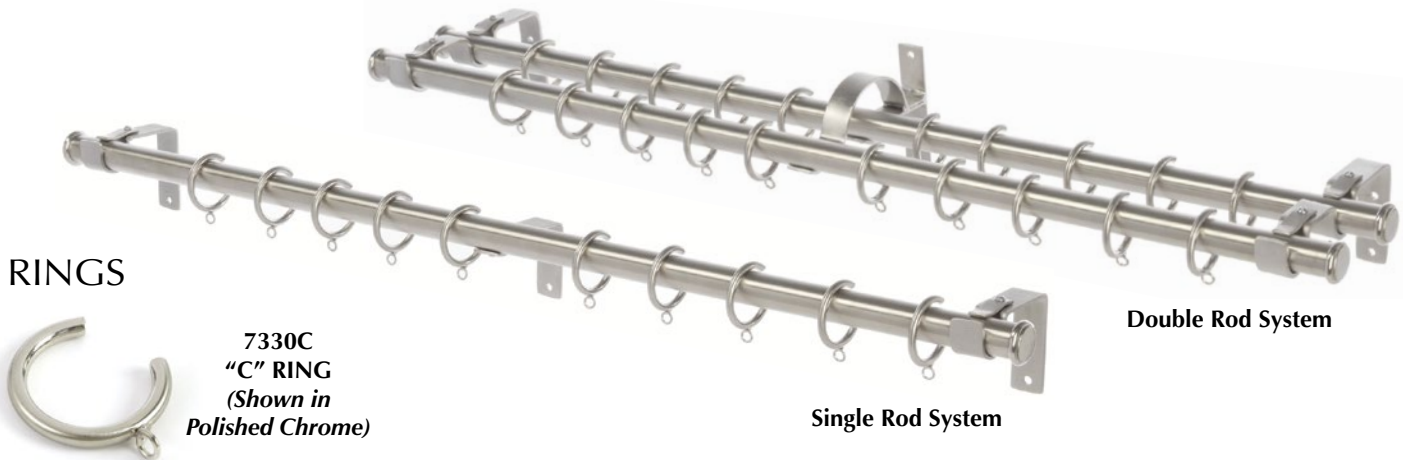

RINGS



7330C
"C" RING
(Shown in
Polished Chrome)

Single Rod System

Double Rod System

BRACKETS



7014SE
3\"/>



7015SE
6\"/>



7040DE
3\"/>



7318-3P
3\"/>

Horizontal Plate Bottom Weld
is available (7318-HP-3\"/>



7318-6P
6\"/>

Horizontal Plate Bottom Weld
is available (7318-HP-6\"/>



7319
3\"/>

ITALIAN FINISHES



Brushed Nickel
IT 201 - Group I



Polished Chrome
IT 206 - Group J



Black Nickel
IT 202 - Group K



Oiled Bronze
IT 203 - Group K



Satin Copper
IT 204 - Group K



Satin Gold
IT 205 - Group K



Polished Nickel
IT 207 - Group J



Black Chrome
IT 208 - Group L



Polished Brass
IT 209 - Group L



Satin Brass
IT 210 - Group L



Antique Brass
IT 211 - Group L



Polished Rose Gold
IT 212 - Group L



Satin Rose Gold
IT 213 - Group L

Bohemia Collection

Decorative Hand Crafted Faceted Crystal-Glass Finials

Available in Iron Art™ Finishes, Italian Finishes, or Your Own Custom Finish. Interior Fit Only. Also For Use as Tiebacks.
FINIALS TO FIT 3/4", 1", & 1 1/4" DIAMETER ROUND & SQUARE HOLLOW IRON RODS, OR 1 1/2" TRAVERSING RODS.



Finial 790

3/4" Long x 2" High - 2" at Base
Shown in Antique Gold (06)



Finial 789

3/4" Long x 2" High - 2" at Base
Shown in New Nickel (12)



Finial 778

1 1/4" Long x 2 3/8" High - 1 1/2" at Base
Shown in Oiled Bronze (IT 203)



Finial 768

1 7/8" Long x 2 1/2" High - 1 5/8" at Base
Shown in Rich Gold (07)

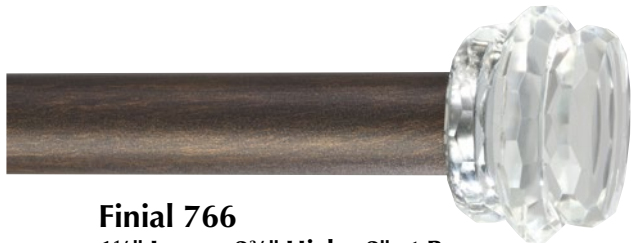

Finial 766

1 1/2" Long x 2 3/8" High - 2" at Base
Shown in Antique Bronze (02)



Finial 785

2 1/2" Long x 1 1/2" High - 1 1/2" at Base
Shown in Polished Chrome (IT 206)



Finial 767

3 1/4" Long x 2" High - 2" at Base
Shown in Naturelle (03)



Finial 769

3 3/8" Long x 2 3/8" High - 1 3/4" at Base
Shown in Oil Rubbed Bronze (34)



Finial 765

3 3/8" Long x 2 3/8" High - 1 1/2" at Base
Shown in Soft Pewter (13)

Bohemia Collection

Decorative Hand Crafted Faceted Crystal-Glass Finials

Available in Iron Art™ Finishes, Italian Finishes, or Your Own Custom Finish. Interior Fit Only. Also For Use as Tiebacks.
 FINIALS TO FIT 3/4", 1", 1 1/4", & 2" DIAMETER ROUND & SQUARE HOLLOW IRON RODS, OR 1 1/2" & 2" TRAVERSING RODS.



*Bohemia Finials
 may be used as Post
 Projection or "U"
 Shape Bend Tiebacks.*

*All are shipped
 in custom boxes
 to ensure high
 quality protection.*



Finial 787
 3 1/2" Long x 2" High - 2" at Base
 Shown in Antique Copper (10)



Finial 783
 1 7/8" Long x 2" High - 2" at Base
 Shown in Bronze Vecchio (15)



Finial 782
 2 7/8" Long x 2 3/4" High - 1 5/8" at Base
 Shown in Brushed Nickel (IT 201)

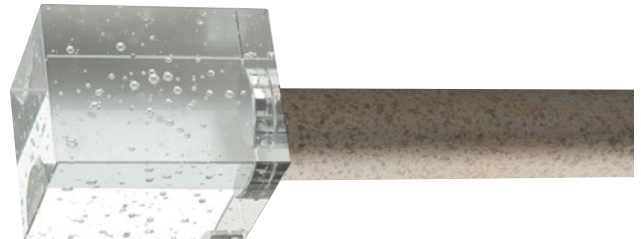

Finial 786
 3" Long x 2 3/8" High - 2 3/8" at Base
 Shown in a Burnt Silver (17)



Finial 784
 2 3/8" Long x 2 7/8" High - 2 7/8" at Base
 Shown in Old Black (01)



Finial 791
 3 5/8" Long x 3 5/8" High - 2" at Base
 Shown in Satin Copper (IT 204)

Bohemia Collection

Decorative Hand Crafted Faceted Crystal-Glass Finials

Available in Iron Art™ Finishes, Italian Finishes, or Your Own Custom Finish. Interior Fit Only. Also For Use as Tiebacks.

FINIALS TO FIT 3/4", 1", 1 1/4", & 2" DIAMETER ROUND & SQUARE HOLLOW IRON RODS, OR 1 1/2" & 2" TRAVERSING RODS.



Finial 781

2 1/8" Long x 2 3/8" High - 1 5/8" at Base
Shown in Antique White (20)



Finial 788

3 1/2" Long x 2" High - 2" at Base
Shown in Black (14)



Finial 771

2 3/8" Long x 2 1/4" High - 1 5/8" at Base
Shown in Antique Gold (06)



Finial 779

1 1/2" Long x 3 1/8" High - 1 5/8" at Base
Shown in Satin Gold (IT 205)



Finial 776

2 3/8" Long x 3 1/8" High - 2" at Base
Shown in Rich Gold (07)



Finial 763

1 1/8" Long x 3 1/4" High - 3 1/4" at Base
Shown in Brushed Nickel (IT 201)



Finial 780

3" Long x 3 1/8" High - 1 5/8" at Base
Shown in Brown (19)



Finial 792

3 3/4" Long x 3 1/4" High - 2" at Base
Shown in a Burnt Silver (17)

Bohemia Collection

Decorative Hand Crafted Faceted Crystal-Glass Finials

Available in Iron Art™ Finishes, Italian Finishes, or Your Own Custom Finish. Interior Fit Only. Also For Use as Tiebacks.
FINIALS TO FIT 3/4", 1", 1 1/4", & 2" DIAMETER ROUND & SQUARE HOLLOW IRON RODS, OR 1 1/2" & 2" TRAVERSING RODS.



Finial 774
2" Long x 2 3/4" High - 1 1/2" at Base
Shown in Rusty (04)

One of the hallmarks of true faceted crystal-glass is that it shows changes and variations in color when viewed from different angles.



Finial 764
3 5/8" Long x 2 1/2" High - 1 5/8" at Base
Shown in Bronze Vecchio (15)



Finial 773
2 3/4" Long x 2 3/8" High - 1 5/8" at Base
Shown in Antique Bronze (02)



Finial 770
3 5/8" Long x 2 1/2" High - 2 1/2" at Base
Shown in Naturelle (03)



Finial 772
2 3/4" Long x 2 3/8" High - 1 3/4" at Base
Shown in Soft Pewter (13)



Finial 775
2 3/4" Long x 2 1/2" High - 1 1/2" at Base
Shown in Oil Rubbed Bronze (34)



Finial 777
3" Long x 2 3/4" High - 2" at Base
Shown in Black Nickel (IT 202)

Promotional Items



8000 - IRON ART PRODUCT WALL DISPLAY - SET ONE
L32" H48"
(TUSCANY DISCONTINUED)



8001 - IRON ART PRODUCT WALL DISPLAY - SET TWO
L32" H48"



8002 - XPRESS YOURWAY QUICK SHIP WALL DISPLAY
L32" H48"



8003 DESIGNER FINIAL SET
6 Finial with Rod Samples



8017 - DESIGNER ROD SIZE SET
9 rod samples with base & top



8006 - TROPICAL (BAMBOO) FINISH SELECTOR SET
All 6 finishes on a metal ring



8011 - DESIGNER SAMPLE KIT
L20" W15" H5" Weight 11 lbs.

8018 - DESIGNER RING SIZE SET
10 ring diameters on hinged snap ring



8016 - SINGLE SQUARE COLOR SELECTOR CHIP



8004 - IRON ART™ FINISH SELECT SET
All 35 finishes in plastic binder sleeves

8005 - WOOD ART™ FINISH SELECT SET
All 11 finishes in a plastic binder sleeve

8014 - ITALIAN FINISH SELECTOR SET
All 13 finishes in a plastic binder sleeve

8008 - COLOR SELECTOR SETS IN BINDER
Iron Art™, Wood Art™, and Italian Collection Finish Selectors

8009 - CATALOG & PRICE LIST SET

8015 - Binder Plus Catalog and Price List

Also available in Semi or High Gloss Finishes. Please add 20% upcharge.

Iron Art Finishes

IRON ART FINISHES: A



09 Light Brown



14 Black



19 Brown

IRON ART FINISHES: B



01 Old Black



02 Antique Bronze



03 Naturelle



04 Rusty



06 Antique Gold



07 Rich Gold



10 Antique Copper



12 New Nickel



13 Soft Pewter



15 Bronze Vecchio



17 Burnt Silver



20 Antique White



32 Ivory



33 Pure White



34 Oil Rubbed Bronze



35 Metal Ore

Please note the finishes presented above are lithographic reproductions of Orion's actual finishes, and as such may not accurately reflect the true depth and tone of our finishes. Please always refer to actual Orion finish samples before ordering our products.

Iron Art Finishes

Also available in Semi or High Gloss Finishes. Please add 20% upcharge.

IRON ART FINISHES: C



11 Versace



16 Gold Antique White



18 Renaissance Silver



24 Sage Gold



25 Burnt Gold



26 Bronze Patina



27 Cherry Gold



28 Vecchio Patina



29 Golden Oak

IRON ART FINISHES: D



05 Autumn



08 Imposter



21 Crackle



22 Antique Crackle



23 Mocha Mix



30 Warm Cherry



31 Sugar Maple

Please note the finishes presented above are lithographic reproductions of Orion's actual finishes, and as such may not accurately reflect the true depth and tone of our finishes. Please always refer to actual Orion finish samples before ordering our products.

... always leaves a lasting impression!

Measurement Guidelines

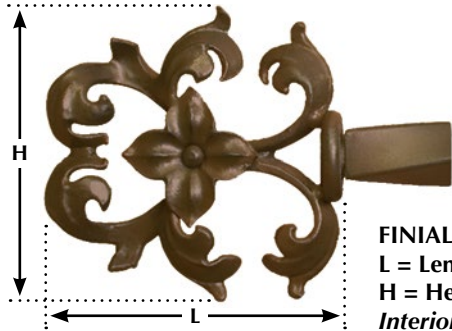

FINIAL 501
L = Length
H = Height
Interior Fit



BRACKET 1028-RND
P = Projection

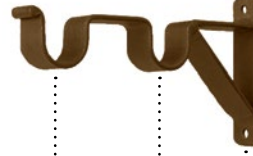

BRACKET 1024DBWS-RND
P = Projection



WOOD BRACKET AMERICAN 5045S
P = Projection



FINIAL 991
L = Length
H = Height
Exterior Fit

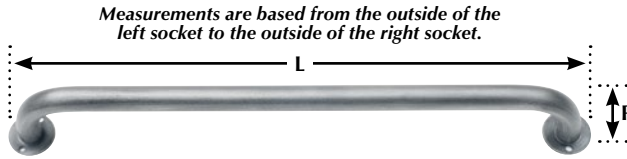

ROD WITH RETURN 264
L = Length
P = Projection



DECORATIVE CORNICE BAMBOO 9040
L = Length
H = Height
P = Projection
WD = Wood Duster



DECORATIVE ROD 254 H = Height • D = Diameter

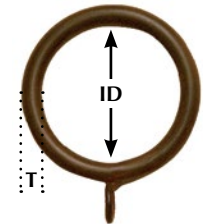

RING 350
ID = Internal Diameter
T = Thickness

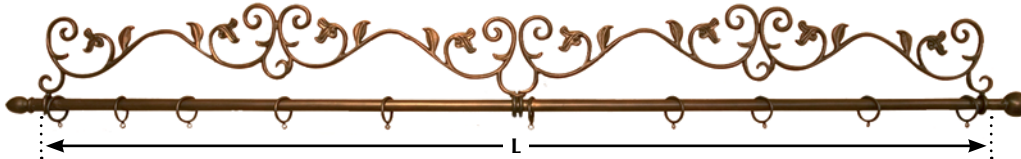

DECORATIVE ROD 280 L = Length

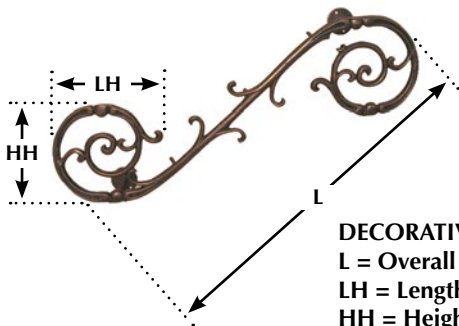
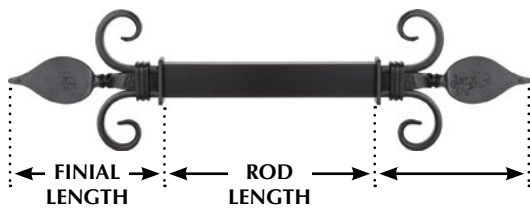

DECORATIVE SCROLL 267
L = Overall Length
LH = Length of Head
HH = Height of Head



SQUARE IRON ROD
WIDTH

IRON ROD AND WOOD POLE DIAMETERS

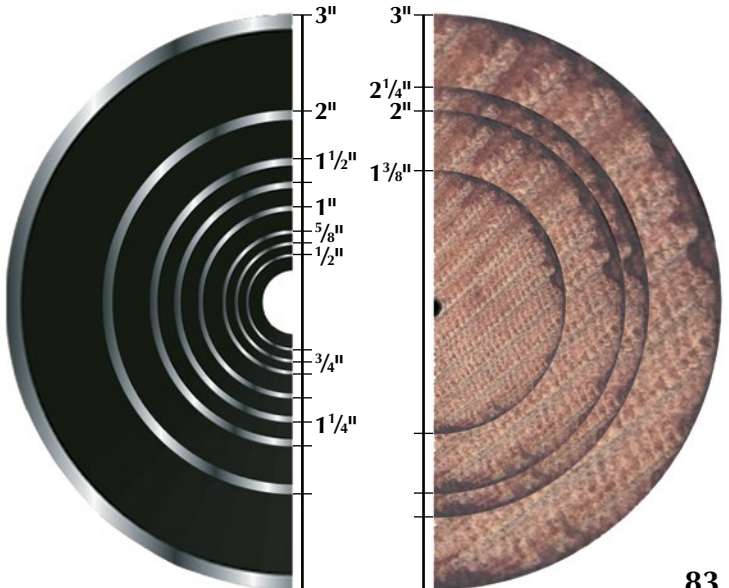

ORION

ORNAMENTAL IRON, INC.



Made in USA

Feb 2022 Reprint

