

### Getting Started — Mounting Type

All of the required installation components are wrapped in the package along with these instructions. Please thoroughly review these instructions before beginning the installation. *Some parts may vary depending upon your selected mounting options or control system options.*

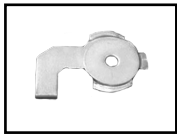

**2 and 3 Way  
Inside/Outside Mount  
Installation Bracket**

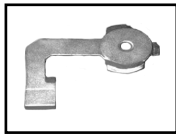

**4 and 4 Way  
Inside/Outside Mount  
Installation Bracket**



**L Bracket  
Outside/Wall Mount**

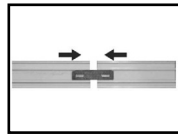

**Track Splice Bracket  
(for tracks over 144" wide)**

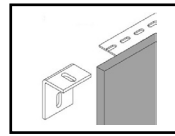

**Installation Bracket  
(Outside Mount Only)  
Slotted Angle Bracket**

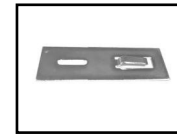

**Deluxe Valance Bracket  
(Outside Mount Only)**

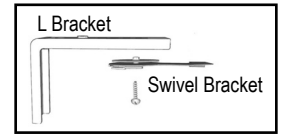

**Outside/Wall Mount  
Bracket Assembly**

If the installation brackets are mounted correctly, the rest of the installation process will follow easily. Prior to mounting the brackets, add any clearance depth required to avoid obstructions:

Mounting Depth Requirements					
Number of Track Channels	IM Flush Mount Depth	IM with Valance Flush Mount Depth	IM Minimum Depth	OM Wall Clearance	OM Overall Projection
2	2-1/2"	3-1/2"	1-3/4"	2-1/2" – 3-1/8"	4-1/8" – 4-3/4"
3	2-3/4"	3-3/4"	1-3/4"	2-1/2" – 3-1/8"	4-1/2" – 5-1/4"
4	3-1/2"	4-1/2"	1-3/4"	2-1/2" – 3-1/8"	5-1/4" – 6"
5	3-1/2"	4-1/2"	2"	1-3/4" – 4"	5-1/8" – 7-3/8"

#### Fasteners

- #8 screws for wood or aluminum
- Plastic inserts for drywall or plaster
- Auger threaded metal or plastic inserts for drywall
- Molly bolts for drywall
- Toggle bolts for drywall or lath & plaster

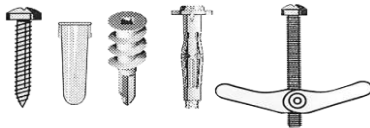

**IMPORTANT:** For installation in wood or aluminum frames, it is recommended you use the sheet metal screws included with your custom shades. For other types of wall or window construction you will need to furnish different fasteners.

**Note:** *Fastener strength should be rated more than the weight of the shade.*

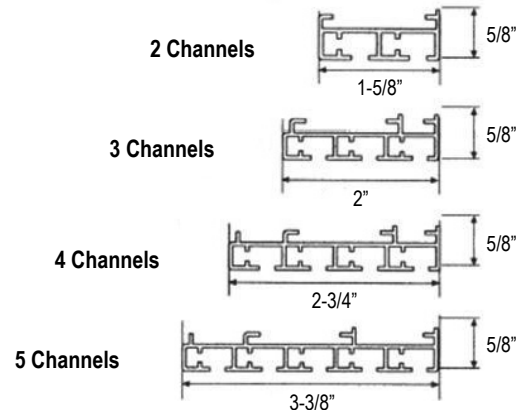

Panel Track hardware installation brackets are either 2 and 3 or 4 and 5 way. **Mounting the brackets level is essential to proper operation.**

### Inside or Ceiling Mount



1



2

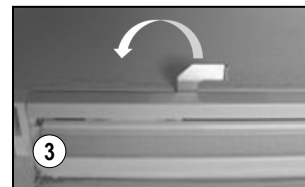

3

**(1) Mark the bracket location.** Measure 4" from the edge of the window frame (or edge of the track for ceiling) on each side and mark the location. Space the additional installation brackets evenly between the 2 end brackets and mark the location(s). Make sure that the brackets are level with each other. Verify adequate clearance allowance is made for panel operation. **(2) Mount the brackets.** Place the bracket(s) against the top of the window frame (or ceiling) and attach using the provided screw(s). **(3) Attach the track.** Position track in place where it is centered in the window and the operating wand is on the correct side. Hook front of track onto the lip of the bracket and snap back of track into back of bracket.

# INSTALLATION INSTRUCTIONS

## Outside and Wall Mount

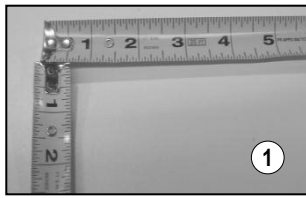

1

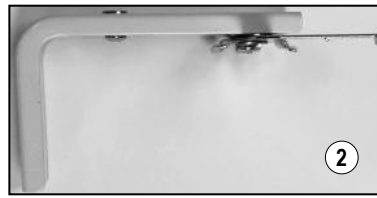

2

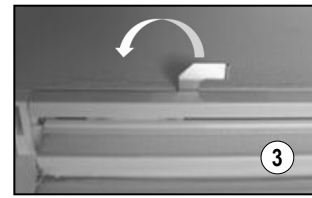

3

**(1) Mark the bracket location.** Measure 4" from the edge of the window frame (or edge of the track for ceiling) on each side and mark the location. Space the additional installation brackets evenly between the 2 end brackets and mark the location(s). Make sure that the brackets are level with each other. Verify adequate clearance allowance is made for panel operation. **(2) Mount the brackets.** Place the wall-mount bracket(s) assembly against the top of the window frame and attach using the provided screw(s). **(3) Attach the track.** Position track in place where it is centered in the window and the operating wand is on the correct side. Hook front of track onto the lip of the bracket and snap back of track into back of bracket.

## Mounting the Panels



First, unpack each panel and align the Velcro strip on the fabric to the one on the carrier. Then, starting from one end, start pressing the fabric against it until the panel is secured. Repeat this process until all panels are in place.

## Mount the Fabric Cornice — INSIDE MOUNT

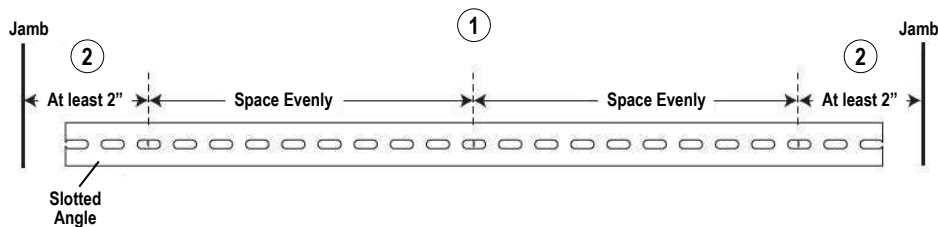

Inside Mount Screws Required	
Width	# of Screws
12" – 28"	3
28-1/8" – 52"	4
52-1/8" – 76"	5
76-1/8" – 100"	6
100-1/8" – 120"	7
120-1/8" – 144"	8

Mounting depth requirement: 1"  
Flush mounting depth requirement: 1-1/2"

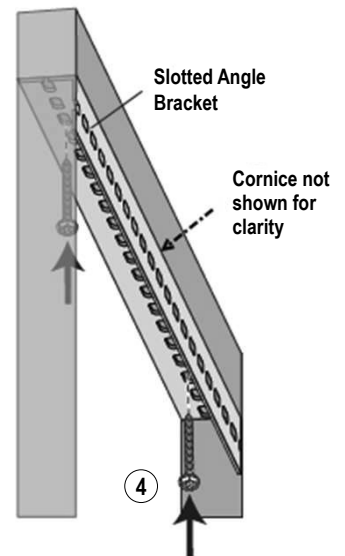
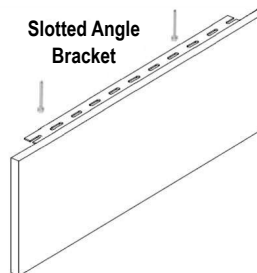

**(1)** Center the cornice in desired location. **(2)** Mark the mounting surface 2" from each jamb for screw location. Center the marks in the bracket slots. *Space screws evenly, but no more than 24" apart.* **(3)** Drill screw holes. **IMPORTANT: Use drywall anchors when mounting into drywall.** **(4)** Install the cornice through the slotted angle bracket to the mounting surface with the #8 x 1-1/4" screws provided.

# INSTALLATION INSTRUCTIONS

## Mount the Fabric Cornice — OUTSIDE MOUNT

Min. Mounting Surface Height Requirement: 2"

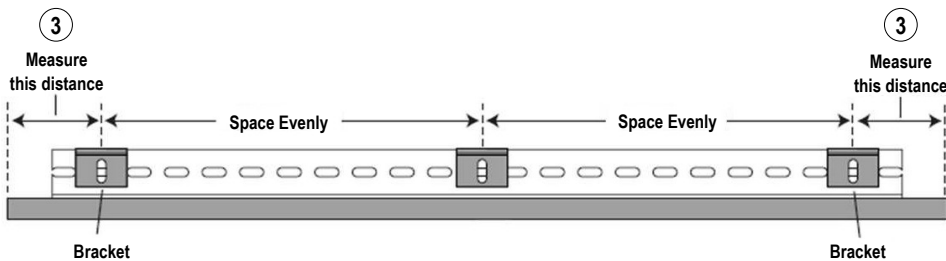
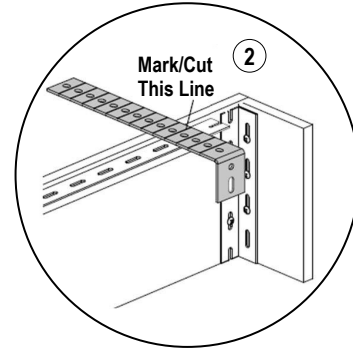
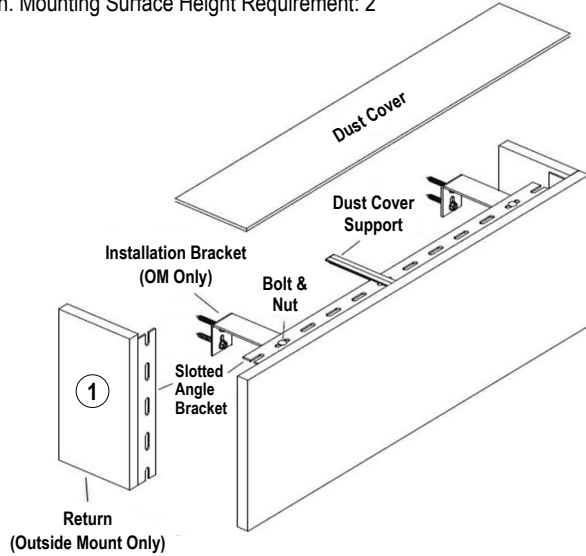

Outside Mount Screws Required	
Width	# of Screws
12" – 28"	2
28-1/8" – 52"	3
52-1/8" – 76"	4
76-1/8" – 100"	5
100-1/8" – 120"	6
120-1/8" – 144"	7

Use the distance measured in the previous step

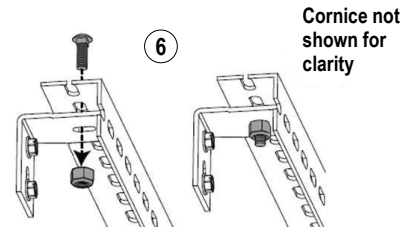
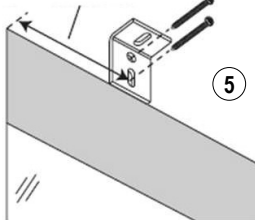

- (1) Attach the returns to the valance. Check the angle on each return, fasten screws into the valance and repeat for opposite return.
- (2) Skip to next step if ordered with a shade. If ordered custom returns under **Fabric Cornice Only (without shade)**, place the 8" bracket on top of the slotted angle next to the return. With the back of the bracket flush with the back edge of the return, mark the cut mark just past the screw hole that lines up with the slotted angle. Then cut the bracket at the mark.
- (3) Measure distance from top edge of cornice to the first complete hole in the slotted angle. Use that measurement to mark the location for the first bracket at the desired height. Repeat for the opposite bracket. *Space brackets evenly, but no more than 24" apart.* (4) Drill screw holes. **IMPORTANT: Use drywall anchors when mounting into drywall.** (5) Attach the installation brackets with the screws provided. Ensure the mounting surface is level and brackets are aligned. Shim brackets, if needed. (6) Using the bolts and nuts provided, attach the slotted angle on top of the installation brackets.

# INSTALLATION INSTRUCTIONS

## Mount the Deluxe Valance — INSIDE MOUNT

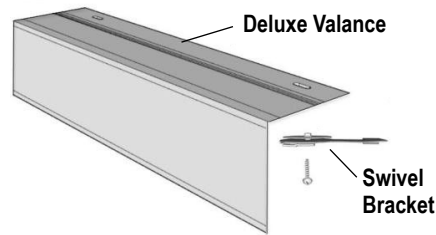

Mount directly with the provided installation screws, drill vertically, with the swivel brackets under the valance, into the top of the window frame.

## Mount the Deluxe Valance — OUTSIDE MOUNT

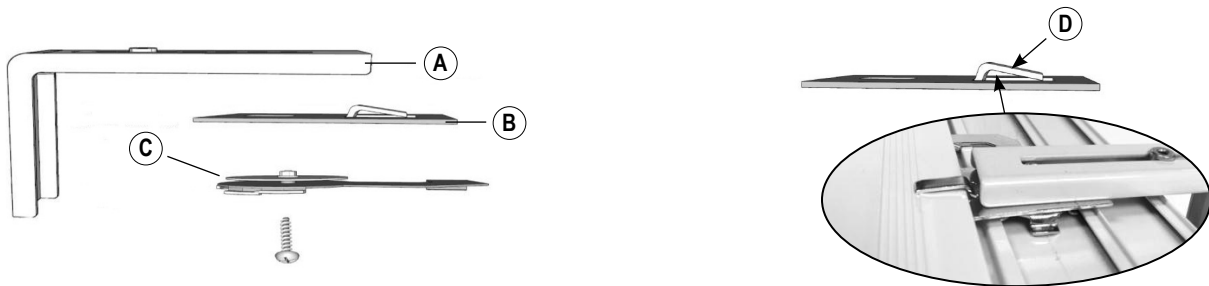

Attach panel track deluxe valance bracket (B) and swivel bracket (C) underneath the L bracket (A). Screw all components together. Once panels are installed, slide the valance between the tab (D) on the deluxe valance bracket.

## Operate the Panel Track

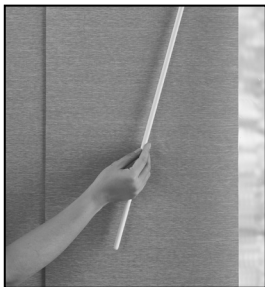

Wand Draw



Cord Draw

Tracks operate with either a wand or with a cord loop draw.

## Install the Cord Tensioner

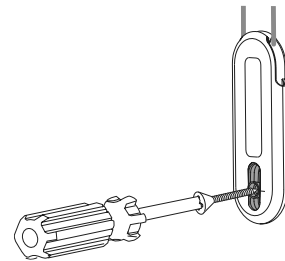

Attach the cord tensioner on the cord loop to the wall or window casement. Refer to the cord tensioner installation kit for instructions on how to install the tensioner.

## Child Safety

Young children can be **STRANGL**ED in cord loops and in the loop above the cord stop. Always keep cords out of children's reach.

- Move cribs, playpens and other furniture away from cords. Children can climb furniture to get to cords.
- Do not tie cords together.
- Make sure cords do not twist together and create a loop.

**WARNING/ADVERTENCIA**

5.1.3 Rev. 5/18 Print 5/18

Window Blind Cord Can **STRANGLE** Your Child. To prevent strangulation, purchase cordless products or products with inaccessible cords.

La cuerda de la persiana puede **ESTRANGULAR** a su niño. Para evitar el estrangulamiento, compre alternativas cuerda o productos con cuerdas inaccesibles.

