

INSTALLATION INSTRUCTIONS

ROLLER SHADES

R-Series

Thank you for your purchase. This shade has been custom built for you from the highest quality materials.

To avoid errors and save valuable time, please read these instructions before installing your new shade.

TABLE OF CONTENTS

INSIDE MOUNT

Shades with No Top Treatment	Page 2
Shades with Square Cassette	Page 2
Shades with Curved Cassette	Page 3
Shades with 3" Fascia	Page 4
Shades with 4" Fascia	Page 5
Shades with Pocket	Page 6
Shades with Fabric Cornice / Deluxe Valance	Page 6

OUTSIDE MOUNT

Shades with No Top Treatment	Page 7
Shades with Square Cassette	Page 7
Shades with Curved Cassette	Page 8
Shades with 3" Fascia	Page 9
Shades with 4" Fascia	Page 10
Shades with Pocket	Page 11
Shades with Fabric Cornice / Deluxe Valance.....	Page 12
Motorized Shades	Page 12
Straightening the Shade	Page 12
Care and Cleaning	Page 12
Child Safety	Page 12

Shades with No Top Treatment — INSIDE MOUNT

All Operating Systems

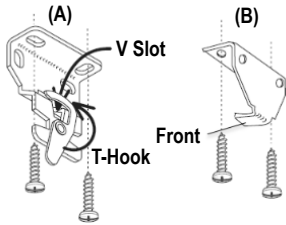

Flush Mount Depth Requirement: 1-1/4"
Min. Mounting Depth Requirement: 1-1/2"

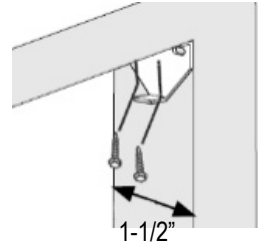

- Determine the control side. Bracket (B) with tab (foot) should be at the control side and the bracket (A) with V slot and T-Hook should be at the idler side.
- The installation brackets are always mounted so that the inner surfaces face each other. Make sure all brackets are leveled and aligned.
- Insert control side into the foot of the bracket.
- Set the **post** of the idler end into the V slot of the idler side bracket. Rotate the T-hook on the idler side bracket **over the post** to lock in the post and secure the fabric roll.

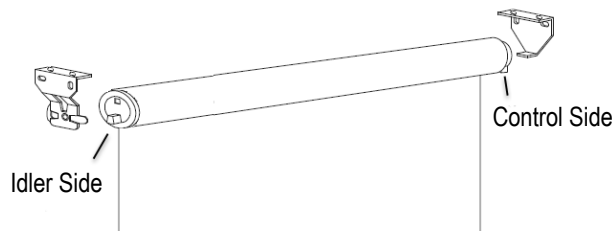

Shades with Square Cassette — INSIDE MOUNT

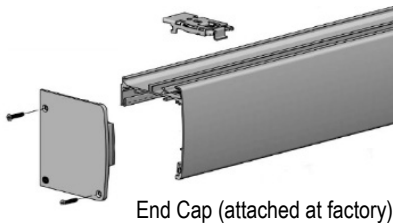

End Cap (attached at factory)

Flush Mounting Depth Requirement: 3-3/4"

Min. Mounting Surface Height Requirement: 1-1/2"

1. Measure correct spacing, mark the desired location
2. Install brackets – Brackets must be in line and level. Shim brackets if necessary.

Follow image below:

1. Hook cassette onto the bracket
2. Push the cassette towards the back
3. Allow the hook at the back of the cassette to engage securely onto the hook at the rear of the bracket.

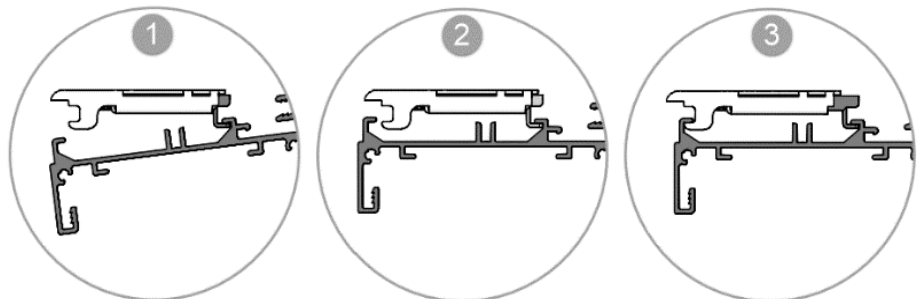

To **Remove** the shade:

Reverse the steps above.

Shades with Curved Cassette — INSIDE MOUNT

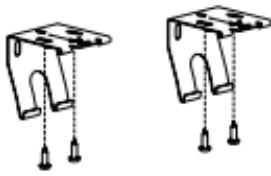

Flush Mounting Depth Requirement:

- 2-7/8" (small curved cassette)
- 3-3/4" (medium curved cassette)
- 4-3/8" (large curved cassette)

Min. Mounting Depth Requirement: 1-1/2"

1. Space brackets evenly. Using the installation bracket as a template, measure to the center of the brackets and mark the hole locations with a pencil for drilling.
2. Install the brackets, make sure all brackets are leveled and aligned. Mount the shade.

Small Cassette

Figure A - Position the cassette valance so that the ridge engages into the top lip of all brackets.

Figure B - Rotate the bottom front of the cassette valance upwards until the rear of the cassette valance engages into the bracket and snaps into place, as shown.

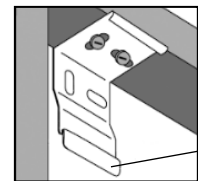
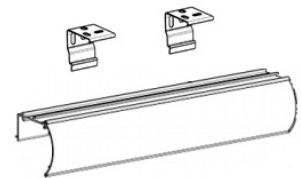
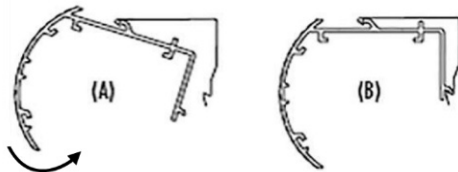

Release Tab

To **remove** the shade

- Hold the cassette at each bracket tab to disengage the rear of the cassette.

Medium/Large Cassette

Figure A - Position and securely engage rear of the cassette into the bottom hooks of the bracket. Rotate cassette upward (1) and push backward (2).

Figure B - Hold the cassette release gently (3) to ensure the top of the cassette engaging into the top lips of all brackets, as shown.

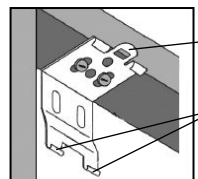
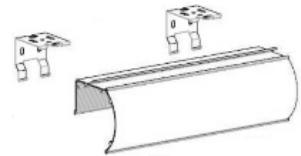
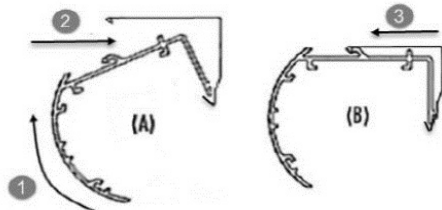

Release Tab

Hooks

To **remove** the shade

- Hold the cassette, gently insert a flathead screwdriver in between the top of the cassette and each bracket tab to assist in releasing the cassette from the top bracket lips. Push the cassette toward the back. Rotate downward to disengage the cassette.

Shades with 3" Fascia — INSIDE MOUNT

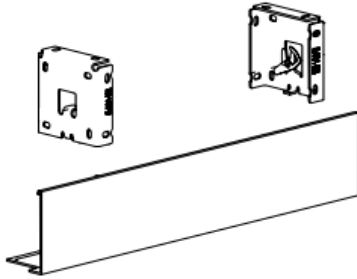

Flush Mount Depth Requirement: 3-1/8"
Min. Mounting Depth Requirement: 2-7/8"

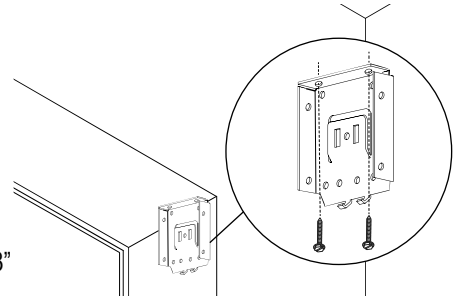

The open end of each bracket faces downward, as shown in the image. The bracket with a tab (foot) in the middle should be at the control side and the bracket with V slot and T-Hook should be at the idler side.

- Install each bracket with two screws through the top. Make sure all brackets are level and aligned.

INSTALL THE SHADE

1. Insert control side of the fabric roll into the tab (foot) in the middle of the bracket.
2. Set the **post** of the idler end into the V slot of the idler side bracket. Rotate the T-hook **over the post** on the idler side bracket to lock in the post and secure the fabric roll.

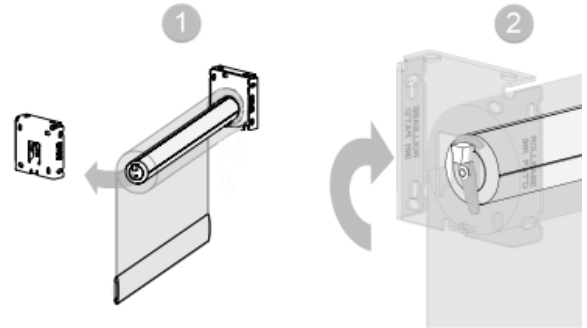

ATTACH THE FASCIA

- Please note, *do not install fascia panel until shade is installed*. Then assemble the two end brackets and the fascia panel.
- Place the top of the fascia panel into the top indentation of the brackets. Rotate the panel down and snap it into place.

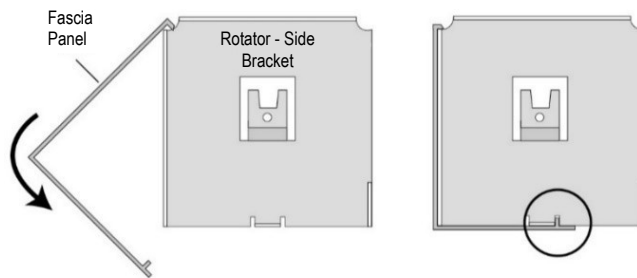

Shades with 4" Fascia — INSIDE MOUNT

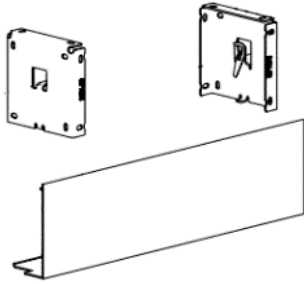

Flush Mount Depth Requirement: 4-3/8"
Min. Mounting Depth Requirement: 3-7/8"

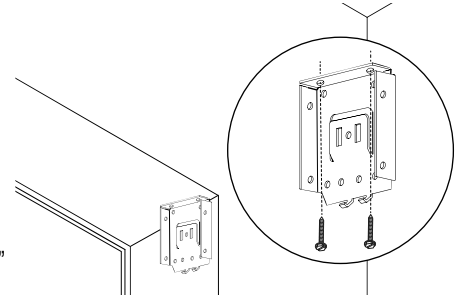

The open end of each bracket faces downward, as shown in the image. The bracket with a tab (foot) in the middle should be at the control side and the bracket with V slot and T-Hook should be at the idler side.

- Install each bracket with two screws through the top.
Make sure all brackets are level and aligned.

NOTE: If shade is ordered with Side and/or Bottom Channel, please refer to **Side/Bottom Channel Installation Instructions**.

INSTALL THE SHADE

1. Insert control side of the fabric roll into the tab (foot) in the middle of the bracket.
2. Set the **post** of the idler end into the V slot of the idler side bracket. Rotate the T-hook **over the post** on the idler side bracket to lock in the post and secure the fabric roll.

ATTACH THE FASCIA

3. Place the top of the fascia panel into the top indentation of the brackets. Rotate the panel down and snap it into place.

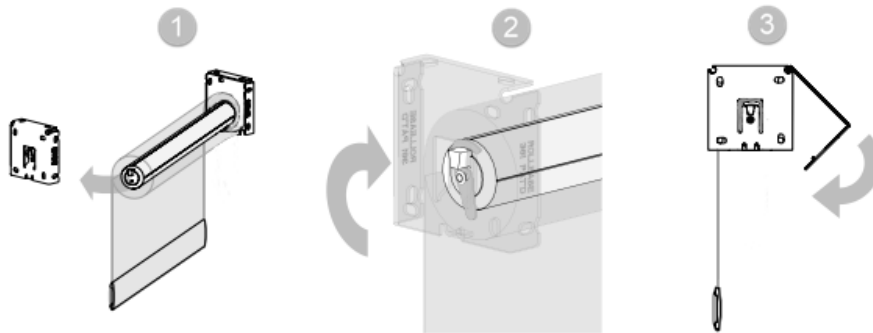

See separate Side/Bottom Channel Installation Instructions.

Shades with Pocket — INSIDE MOUNT

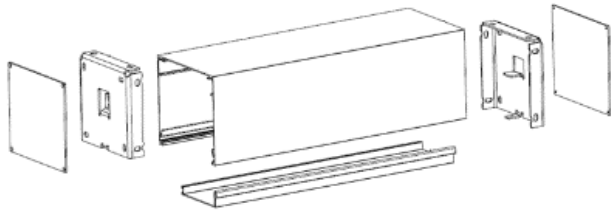

Flush Mounting Depth Requirement: 4-9/16"

Min. Mounting Depth Requirement: 3-5/8"

INSTALL MOUNTING BRACKETS

1. Insert bracket into the pocket. Attach end plate onto the side bracket.
2. Using appropriate screws, install pocket into top or window frame.

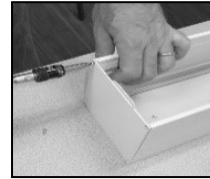
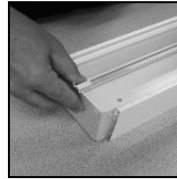

NOTE: If shade is ordered with side and/or bottom channel please go to **Side/Bottom Channel Installation Instructions**. If not, skip to Install the Shade.

INSTALL THE SHADE

1. Insert control side of the fabric roll into the tab (foot) in the middle of the control side bracket.



2. Set the **post** of the idler end into the V slot of the idler side bracket. Rotate the T-hook **over the post** on the idler side bracket to lock in the post and secure the fabric roll.

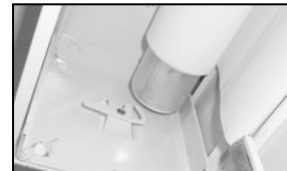

3. Install Bottom Closure into the pocket on an angle.
Once aligned, allow front of bottom closure to drop in place.



See separate Side/Bottom Channel Installation Instructions.

Shades with Fabric Cornice or Deluxe Valance — INSIDE MOUNT

Please see separate Roller Shades — Fabric Cornice and Deluxe Valance installation instructions.

Shades with No Top Treatment — OUTSIDE MOUNT

All Operating Systems

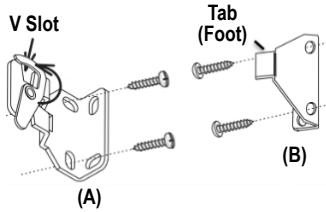

Min. Mounting Surface Height Requirement: 1-3/4"

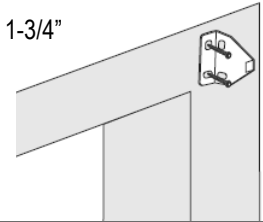

- Determine the control side. Bracket (B) with tab (foot) should be at the control side and the bracket (A) with V slot and T-Hook should be at the idler side.
- The installation brackets are always mounted so that the inner surfaces face each other. Make sure all brackets are leveled and aligned.
- Insert control side into the foot of the bracket.
- Set the **post** of the idler end into the V slot of the idler side bracket. Rotate the T-hook on the idler side bracket **over the post** to lock in the post and secure the fabric roll.

Shades with Square Cassette — OUTSIDE MOUNT

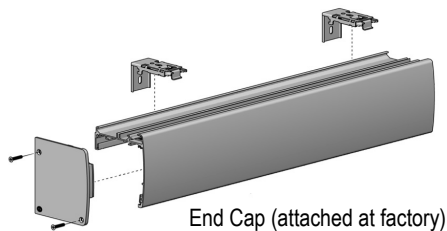

Min. Mounting Surface Height Requirement: 4"

- Measure correct spacing
- Install brackets – face fix wall mount, top fix ceiling mount.
Brackets must be in line and level.
 - Shim brackets if necessary.

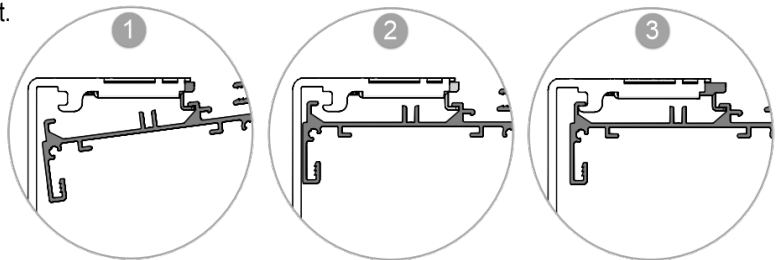

To **Remove** the shade:

- Reverse the steps above.

Shades with Curved Cassette — OUTSIDE MOUNT

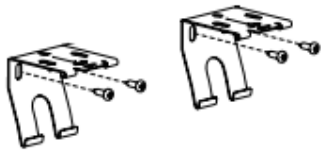

Min. Mounting Surface Height Requirement:

- 2-3/4" (small curved cassette)
- 3-1/8" (medium curved cassette)
- 4" (large curved cassette)

Small Cassette

Figure A - Position the cassette valance so the ridge engages into the top lip of all brackets.

Figure B - Rotate the bottom front of the cassette valance upwards and towards the bracket until the rear of the cassette valance engages into the bracket and snaps into place, as shown.

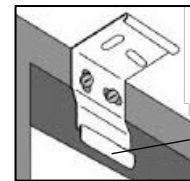
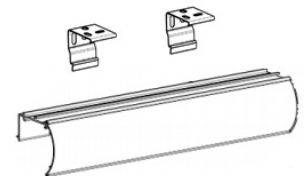
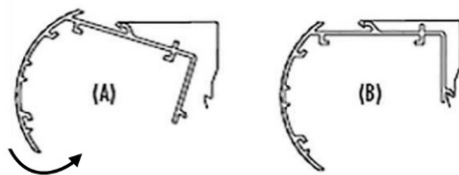

Release Tab

To **remove** the shade

- Hold the cassette at each bracket tab to disengage the rear of the cassette.

Medium/Large Cassette

- Space brackets evenly. Using the installation bracket as a template, measure to the center of the brackets and mark the hole locations with a pencil for drilling.
- Install the brackets, make sure all brackets are leveled. Mount the shade.

Figure A - Position and securely engage rear of the cassette into the bottom hooks of the bracket.

Rotate cassette upward (1) and push backward (2).

Figure B - Hold the cassette release gently (3) to ensure the top of the cassette engaging into the top lips of all brackets, as shown.

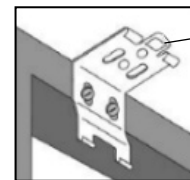
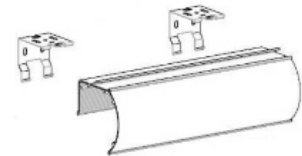
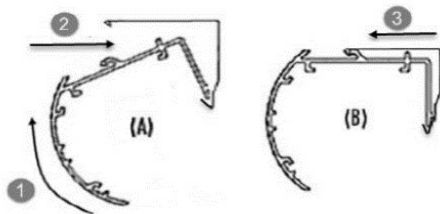

Release Tab

To **remove** the shade

- Hold the cassette, gently insert a flathead screwdriver in between the top of the cassette and each bracket tab to assist in releasing the cassette from the top bracket lips. Push the cassette toward the back. Rotate downward to disengage the cassette.

Shades with 3" Fascia — OUTSIDE MOUNT

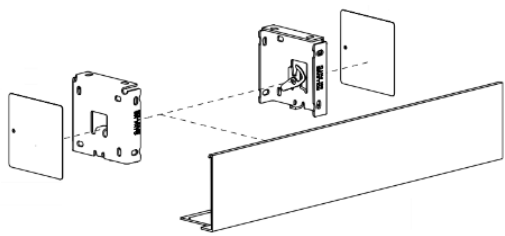

Min. Mounting Depth Requirement: 3"

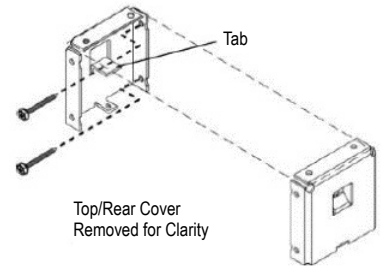

INSTALL THE MOUNTING BRACKETS

The open end of each bracket faces downward, as shown in the image.

- Attach each bracket to the mounting surface using the two holes in the rear of each bracket.
- Use a level to make sure brackets are leveled.

INSTALL THE SHADE

- Insert control side of the fabric roll into the tab (foot) in the middle of the bracket.
- Set the **post** of the idler end into the V slot of the idler side bracket.
Rotate the T-hook on the idler side bracket to lock in the post and secure the fabric roll

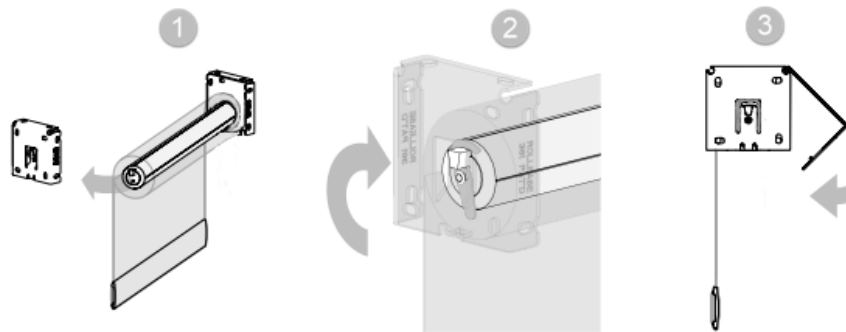

INSTALL THE FASCIA

- Please note, *do not install fascia panel until shade is installed*. Then assemble the two end brackets and the fascia panel.
- Place the top of the fascia panel into the top indentation of the brackets. Rotate the panel down and snap it into place.

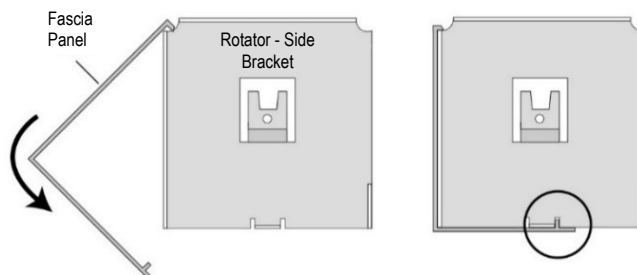

- Attach bracket end plate to the brackets.

Shades with 4" Fascia — OUTSIDE MOUNT

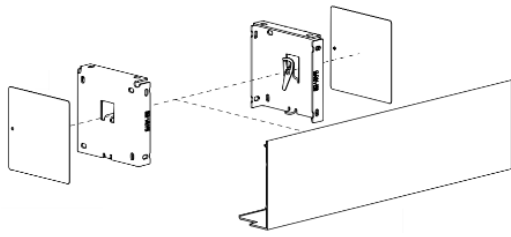

Min. Mounting Depth Requirement: 4'

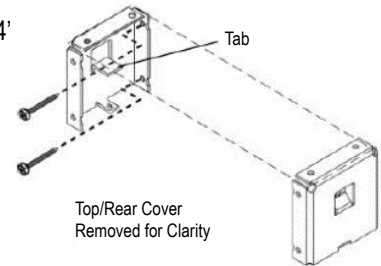

INSTALL THE MOUNTING BRACKETS

The open end of each bracket faces downward, as shown in the image. The bracket with a tab (foot) in the middle should be at the control side and the bracket with V slot and T-Hook should be at the idler side.

- Mount brackets to the wall using the two holes in the rear of each bracket for wall mount. For ceiling mount, mount brackets to the ceiling using two holes in the top of each bracket.
- Use a level to make sure brackets are leveled.

NOTE: If shade is ordered with Side and/or Bottom Channel, please refer to **Side/Bottom Channel Installation Instructions**.

INSTALL THE SHADE

1. Insert control side of the fabric roll into the tab (foot) in the middle of the bracket.
2. Set the **post** of the idler end into the V slot of the idler side bracket. Rotate the T-hook **over the post** on the idler side bracket to lock in the post and secure the fabric roll.

ATTACH THE FASCIA

3. Place the top of the fascia panel into the top indentation of the brackets. Rotate the panel down and snap it into place.

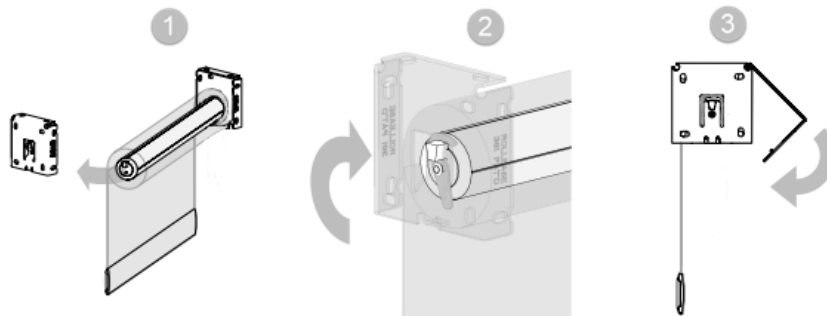

See separate **Side/Bottom Channel Installation Instructions**.

Shades with Pocket — CEILING MOUNT

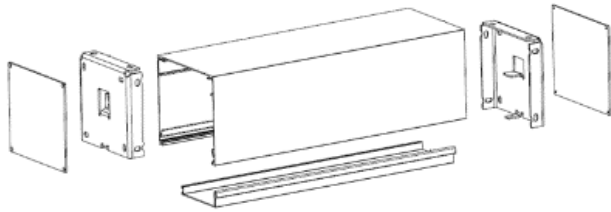

Min. Mounting Surface Height Requirement: 4-1/2"

INSTALL POCKET & MOUNTING BRACKETS

1. Mount pocket to ceiling using the appropriate mounting screws.
2. Pre-drill mounting holes, and use anchor if needed.
3. Make sure all brackets are level.
4. Insert bracket into the pocket (use mallet to gently tap bracket into place) until flush with the end of the pocket. Secure bracket to pocket with supplied mounting screws.
5. Secure end plate to the pocket



NOTE: If shade is ordered with side and/or bottom channel please go to **Side/Bottom Channel Installation Instructions**.
If not, skip to shade installation.

INSTALL THE SHADE

1. Insert control side of the fabric roll into the tab (foot) in the middle of the control side bracket.



2. Set the **post** of the idler end into the V slot of the idler side bracket. Rotate the T-hook **over the post** on the idler side bracket to lock in the post and secure the fabric roll.



3. Install Bottom Closure into the pocket on an angle.
Once aligned, allow front of bottom closure to drop in place.



See separate Side/Bottom Channel Installation Instructions.

Shades with Fabric Cornice or Deluxe Valance — OUTSIDE MOUNT

Please see separate Roller Shades — Fabric Cornice and Deluxe Valance installation instructions.

Motorized Shades

Please see separate motorization programming instructions provided for more details.

Straightening the Shade

If your shade does not roll up evenly (telescoping)

- First check the mounting brackets are aligned and level. (Please use a leveling device to check)

IF shade STILL does not roll evenly.

- Unroll the shade until you can see where the fabric is attached to the roller tube.
- Place a small piece of evenly cut masking tape at the **opposite end** from where the fabric gathers (telescoping).
- A second or even third piece can be placed until shade is rolled up evenly.

CARE AND CLEANING

Roller Shades are made of the highest quality materials for extended wear. If it is not damaged or exposed to a great deal of direct sunlight, it is not unrealistic to expect years of enjoyment with minimal care. Raising and lowering shades periodically helps reduce most natural dust accumulation. If additional cleaning is desired, regular dusting with a feather duster or carefully cleaned with a soft vacuum brush attachment.

Fabric: Vacuum your roller shade frequently. This will keep your roller shade looking like new! If your roller shade becomes soiled use a high-quality foam upholstery cleaner.

Transparent and Vinyl: Transparent and vinyl shades can be readily cleaned with any standard commercial window spray cleaner, which should be diluted with 10 parts water to 1 part cleaning solution. For best results, shades should be removed from brackets, then placed on a clean, flat covered surface. To prevent streaking and inconsistent drying, wash and dry one small area at a time. Do not rub hard. Use a soft, lint-free cloth for washing and drying.

CHILD SAFETY

 WARNING/ADVERTENCIA	
5.1.3	Rev. 5/18 Print 5/18
	Window Blind Cord Can STRANGLE Your Child. To prevent strangulation, purchase cordless products or products with inaccessible cords. La cuerda de la persiana puede ESTRANGULAR a su niño. Para evitar el estrangulamiento, compre alternativas cuerda o productos con cuerdas inaccesibles.



1021030