

// Product Components Guide



ALTA
WINDOW FASHIONS
design simplified

VERTICAL
SHADINGS

TABLE OF CONTENTS

Product Specifications

• Product Components	2-3
----------------------------	-----

PRODUCT COMPONENTS

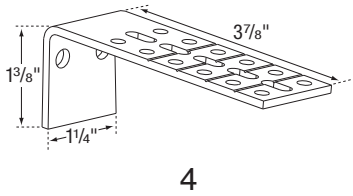
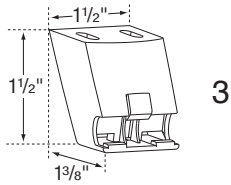
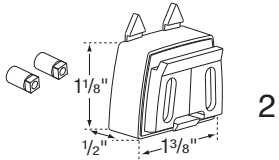
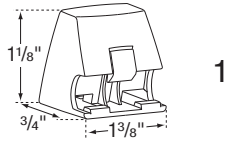

5

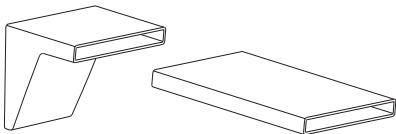

7

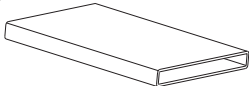

6

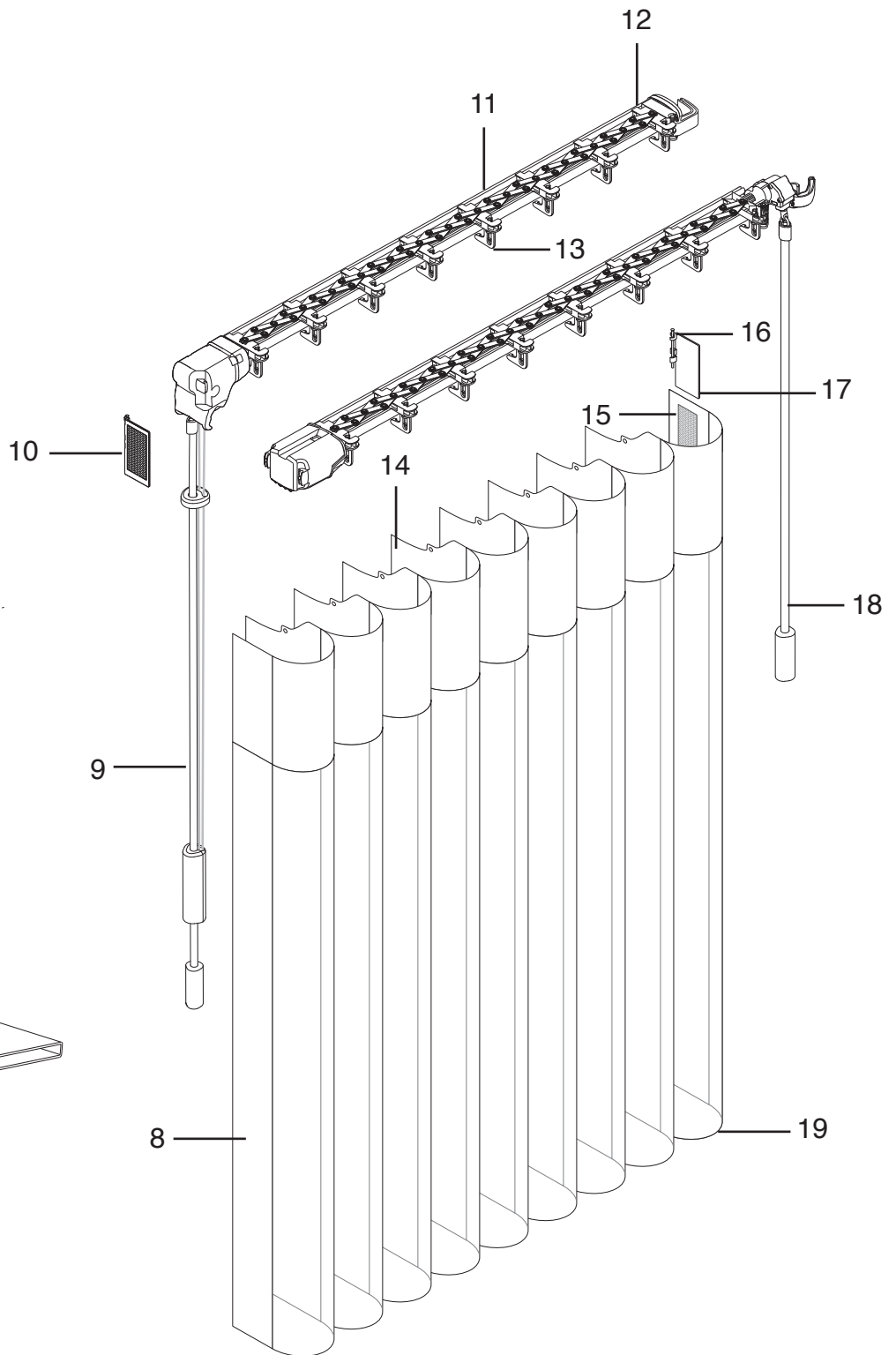

PRODUCT COMPONENTS

1. Outside Mount Installation Bracket Faceplate (Part #KIT8000)
2. Outside Mount Spacer Block with Bushings (Part #KIT8021)
3. Inside/Ceiling Mount Bracket (Part #KIT8005)
4. Extension Bracket (Part #KIT2013)
5. Extension Bracket Base Cover (Part #KIT8011)
6. Universal Shim (included in Bracket Kits)
7. Extension Bracket Cover
8. End Treatment
9. Combination Wand/Cord
10. Swivel Plate LH (Part #4250121000)
11. Headrail
12. Lead Carrier Assembly
13. Tilt Reduction Pinion Clip
14. Vane
15. Hook and Loop Fastener
16. Rivet
17. Swivel Plate RH (Part #4250120000)
18. Moving Wand (Optional) (Part #425009XXXX)
19. Vertical Shadings