

# INSTALLATION & OPERATING INSTRUCTIONS

## WOOD BLINDS

2" and 2-3/8" SLAT SIZES

### Standard

(all slat sizes)

### Cordless Lift

(all slat sizes)

### Cordless Lift & Lock

(all slat sizes)

## FAUX WOOD BLINDS

2" and 2-1/2" SLAT SIZES

### Motorized

(all slat sizes)

### Cordless XL



(all slat sizes)

Thank you for your purchase. This blind has been custom built for you from the highest quality materials.  
To avoid errors and save valuable time, please read these instructions before installing your new blinds.

## TOOLS YOU WILL NEED

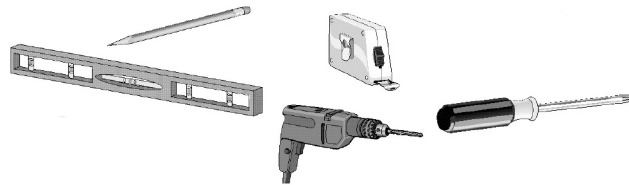
1. Pencil or Marker
2. Measuring Tape
3. Flat-Head Screwdriver
4. Phillips Screwdriver
5. Carpenter's Level
6. Power Drill
7. Mounting Fasteners

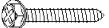

Mounting Surface	Fastener
Drywall, Plaster	Wall Anchors, Expansion Bolts (Not provided) 
Metal	Sheet Metal Screws (Not provided) 
Wood	No. 6 Hex Head Screws (Provided) 

## TABLE OF CONTENTS

Getting Started .....	Page 2
Mounting Type .....	Page 2
Bracket Installation .....	Page 2
Inside Mount .....	Page 3
Outside Mount .....	Page 3
Ceiling Mount .....	Page 4
Installing the Blind .....	Page 4
Installing Components .....	Page 4-5
Installing the Valance .....	Page 5-6
Operating the Blind .....	Page 6-7
Motorized Shades .....	Page 7
Troubleshooting .....	Page 7
Care and Cleaning .....	Page 8
Child Safety .....	Page 8

## GETTING STARTED

All of the required installation components are wrapped in your package along with these instructions. Check that the parts you have correspond to the parts shown below.

**NOTE:** Some parts may vary depending upon your chosen mounting options, whether intermediate brackets are required or your chosen control system options.

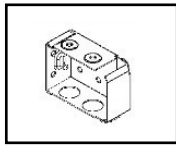

**Installation Brackets**

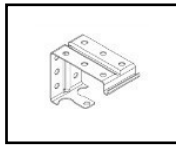

**Center Support Bracket**  
(binds over 48" wide)

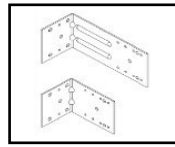

**Short or Long Extension Brackets**  
(optional)

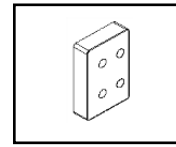

**3/8" or 3/4" Spacer Blocks**  
(3/8" comes with 2-3/8" & 2-1/2" slats)

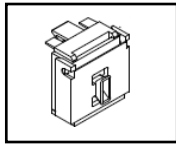

**Adjustable-Magnetic Valance Clips**

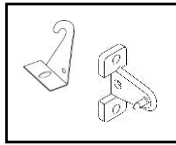

**Hold Down Brackets**  
(2 versions, optional)

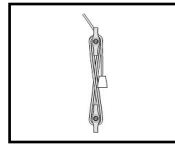

**Cord Cleats**  
(included with all blinds with free hanging cords)

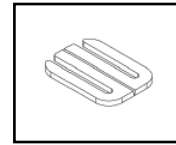

**Bracket Shims**

## Mounting Types

If the installation brackets are mounted correctly, the rest of the installation process will follow easily. To prepare for this important first step, review the mounting types and basic window terminology illustrated below.

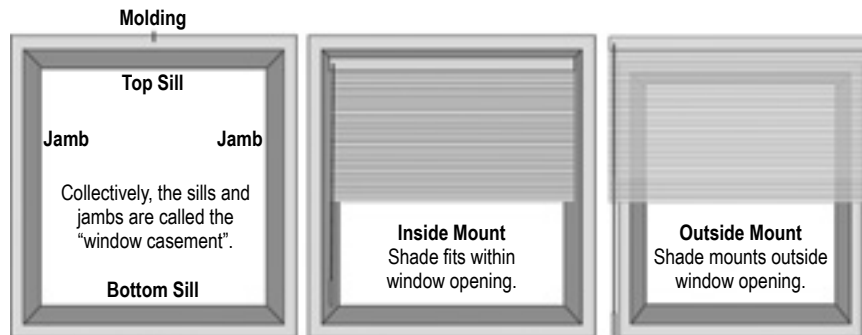

## Bracket Installation

The installation brackets may be for **INSIDE**, **OUTSIDE** or **CEILING** mounts. The brackets are stamped R.H. (right hand) and L.H. (left hand) for easy identification.

Brackets must be level for installation.

**SPACER BLOCKS** (3/8" standard for 2-3/8" & 2-1/2" slats):

- Spacer blocks will be attached to the end of each bracket.
- If installing extension brackets, do not use spacer blocks.



**Spacer block to end of bracket**

Blinds Width	Center Support Brackets Required
12" to 48"	0
48-1/8" to 60"	1
60-1/8" to 120"	2

## Inside Mount

For inside mounts the installation brackets may be screwed in place either through the side or through the top holes.

### ATTACH THE BRACKETS

- For better side mounting, screw through one side and one top hole.
- For limited surface depths, screw through two diagonal side holes.
- For top mounting, screw through the two top holes.

Inside mount bracket screwed through side and top holes

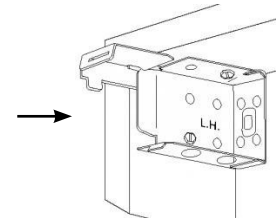

### CENTER SUPPORT BRACKETS (if required):

1. Space evenly between the two end brackets.
2. Adjust if necessary to avoid interference with internal headrail parts.
3. Attach with screws through two diagonal holes.

Inside Mount Depth Requirements

Slat Size	Bracket Depth	Flush to Valance Depth
2"	1-1/8"	3-1/2"
2-3/8"	1-1/8"	3-7/8"
2-1/2"	1-1/8"	3-7/8"

## Outside Mount

For outside mounts, ensure that a 1-3/4" high, flat vertical surface is available for securing the brackets. The brackets will be screwed through the back holes.

### MOUNT THE BRACKET POSITIONS

1. Mark where the ends of the headrail will be positioned.
2. Hold headrail up and mark or measure headrail and mark length.
3. Then mark 1/4" from the headrail marks for the installation brackets.

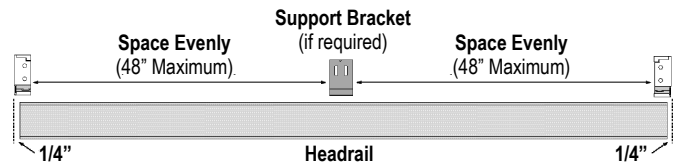

### ATTACH THE BRACKETS

1. Position the outside edge of the brackets to the outer markings.
2. The bracket tops must be aligned and level to one another.
3. Attach the brackets with screws through two diagonal holes.

Inside mount bracket screwed through side and top holes

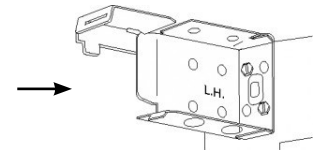

### CENTER SUPPORT BRACKETS (if required):

1. Space the center bracket(s) evenly between the two end brackets.
2. Adjust if necessary to avoid interference with headrail mechanisms.
3. Attach with screws through two diagonal holes.

### EXTENSION BRACKETS (optional):

1. Position the extension brackets to the wall markings made above.
2. The bracket tops must be aligned and level to one another.
3. Mount the extension brackets with screws through diagonal holes.
4. Attach the installation brackets to the extension brackets.

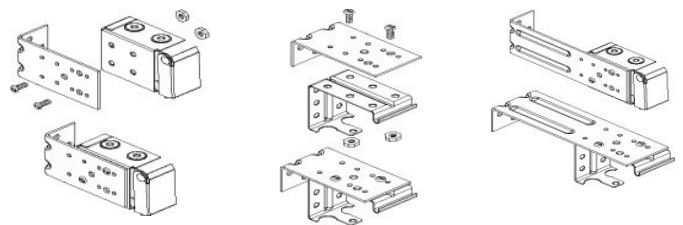

**Installation brackets and center support brackets are attached to extension brackets with the included screws and nuts.**

## Ceiling Mount

For ceiling mounts, ensure that a 1-3/4" high, flat vertical surface is available for securing the installation brackets. The brackets will be normally be screwed in place through the top holes, but see optional attachments below.

### MARK THE BRACKET POSITIONS

1. Mark where the ends of the headrail will be positioned.
2. Hold headrail up and mark or measure headrail and mark length.
3. Then mark 1/4" from the headrail marks for the installation brackets.

### ATTACH THE BRACKETS

1. For normal ceiling mounts, screw through the top holes.
2. If brackets sides are also flat to wall, screw through top & side holes.
3. If brackets backs are flat to wall, screw through top & back holes.

## Installing the Blind

With the installation brackets in place, the headrail may be mounted –

### OPEN THE INSTALLATION BRACKET DOOR LATCHES

- Press up on the bracket bottoms while lifting the bracket doors open.

### MOUNT THE HEADRAIL

1. Tilt the headrail slightly backwards to lower the back-side lip.
2. Slide the headrail into the brackets and push it all the way back.
3. The front lip of the headrail should hook to the center support lips.

### VERIFY HEADRAIL FIT

- If the headrail moves left or right more than 1/8", adjust using a flat head screwdriver, bend the end stiffener tabs out.

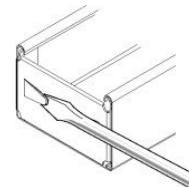

### CLOSE THE BRACKET DOOR LATCHES

- Snap the door shut over the locking tab to secure.

## Installing Components

With the blind properly mounted and in place, these optional components may now be attached. They include the hold-down brackets and wand filter (if ordered).

### ATTACH THE HOLD DOWN BRACKETS (optional)

1. Attach brackets to the window sill or an outside surface.
2. Lower the blind, align bottom rail pins to the hole or hook.



### ATTACH THE HOLD DOWN BRACKETS (optional 2" Cordless Lift & Lock)

1. Lower the blind and place the hold down pins into the bottom rail end caps.
2. Mark the hold down bracket locations on the mounting surface.
3. With the brackets level, attach them using two screws.

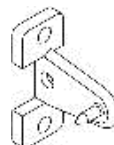

## Install Components — Wand (Optional)

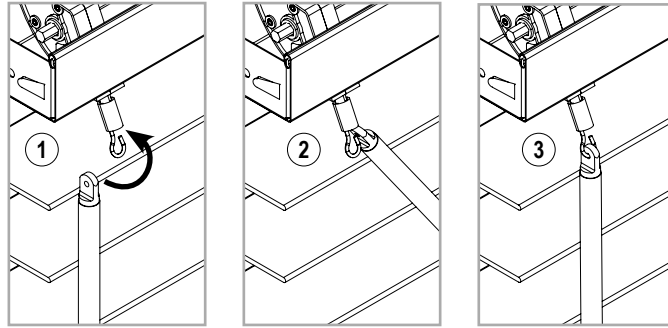

## Installing the Valance

### ATTACHING THE MAGNETIC VALANCE CLIPS TO THE VALANCE

The magnetic valance clips are adjustable for quick and easy valance attachment and have multi-position valance adjustment capabilities.

1. To install the magnetic clips, lay the valance face down on a protected surface with the back side up.
2. Insert the clip dovetail into the valance groove and twist the clip until it is straight with the clear tabs at the top of the valance.
  - There are at least two clips per valance. For valances narrower than 36", position clips 5-1/2" in from the ends of the valance. For valances 36" or wider, position the clips 10" in from the ends of the valance. Additional clips should be spaced evenly between the two end clips.

Valance Width	# of Valance Clips
Up to 52"	2
52-1/8" to 82"	3
82-1/8" to 120"	4
120-1/8" to 150"	5
150-1/8" to 168"	6

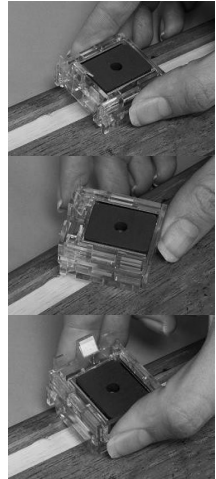

### ATTACHING THE VALANCE TO THE HEADRAIL

Align the valance to the headrail:

1. Hold the valance securely from the front side with both hands.
2. Position the magnetic valance clips to the top-front lip of the headrail until it is level and in position.
3. Press the valance gently forward, just enough so the magnetic valance clips adhere to the headrail.

Adjust the valance projection:

- **Inside Mount:** Press the valance forward until the face is flush with the opening or the magnetic valance clips are attached to the headrail.
- **Outside Mount:** Press the valance forward until the magnetic valance clips are attached to the headrail. To minimize the gap between the valance return and the wall, follow the valance clip projection adjustment instructions on page 6.

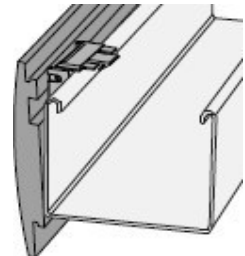

The magnetic valance clips allow for limited valance height adjustments by carefully sliding the valance clip up or down while the magnets are adhered to the headrail. The magnetic valance clips tabs rest on the top-front lip of the headrail, keeping the valance level and preventing the valance from adjusting lower beyond that point.

To remove the valance, gently pull the valance towards you.

**CAUTION:** The entire surface area of the magnet inside each clip needs to maintain clean contact with the front surface area of the headrail at all times.

## Installing the Valance

### ADJUSTING THE PROJECTION

The magnetic valance clips have a projection adjustment feature. By pulling the clips outward, the clips can provide an additional 1/4" projection.

1. Remove the magnetic valance clips from the valance.
2. Insert a small flat head screwdriver into the slot on one side of the magnet making sure the screwdriver is all the way down in the slot.
3. Push the screwdriver in towards the magnet and then pull out to extend the magnetic valance clip.
4. Repeat on the other side until the magnet is level.
5. When the magnetic valance clips are in the correct position, place the magnetic valance clips back into the valance groove.

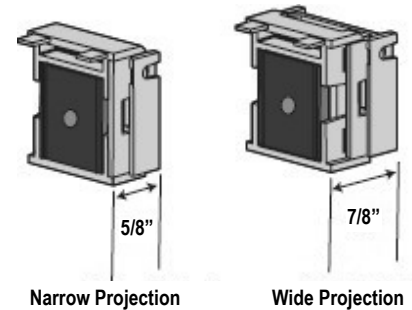
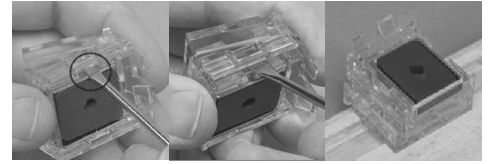

The clips offer three projection positions.

When the clips are fully compressed, the narrowest projection is 5/8". The widest projection is 7/8".

## Operating the Blind

Please refer to the ordered control system options below for instructions on how to properly operate your blind.

### Standard Rectangular Blinds

#### TO TILT THE SLATS:

- Pull on one of two **tilt cords** to rotate slats forwards or backwards.
- Rotate the **wand tilter** (if ordered) to rotate slats forwards and backwards.

#### TO RAISE AND LOWER THE BLIND:

- Tilt the slats to the open position (flat and parallel to headrail).
- Pull the single lift cord down and toward the center of the blind.
- Raise or lower blind to desired position, move the cord **toward the outside of the blind to lock**, then release.

### Cordless Lift Blinds

#### TO TILT THE SLATS:

- Pull on one of two **tilt cords** to rotate slats forwards or backwards.
- Rotate the **wand tilter** (if ordered) to rotate slats forwards and backwards.

#### TO RAISE AND LOWER THE BLIND:

- Tilt the slats to the open position (flat and parallel to headrail).
- Hold the **center portion of the bottom rail** to ensure level movement.
- Lower the blind by gently pulling downward to the desired position.
- Raise the blind by gently pushing upward to the desired position.

### Cordless XL

#### TO TILT THE SLATS:

- Rotate the **wand tilter** to rotate slats forwards and backwards.

#### TO RAISE AND LOWER THE BLIND:

- Tilt the slats to the open position (flat and parallel to headrail).
- Hold the **center portion of the bottom rail** to ensure level movement.
- Lower the blind by gently pulling downward to the desired position.
- Raise the blind by gently pushing upward to the desired position.

## Operating the Blind

Please refer to the ordered control system option below for instructions on how to properly operate your blind.

### Cordless Lift & Lock Blinds

TO TILT THE SLATS:

- Pull on one of two **tilt cords** to rotate slats forwards or backwards.
- Rotate the **wand tilter** (if ordered) to rotate slats forwards and backwards.

TO RAISE THE BLIND:

- Tilt the slats to the open position (flat and parallel to headrail).
- Grasp the bottom rail near the center with one hand while balancing the bottom rail with your other hand.
- Fully press the center button with your thumb and gently lift the bottom rail.
- Allow the slats to stack evenly by gradually lifting the bottom rail while the center button is fully depressed.
- Hold the rail still at the desired position while releasing the button.

FOR INSIDE MOUNT BLINDS:

When raising the blind, pull the bottom rail slightly toward you. Press the center button and gently raise the bottom rail. Once the desired height is reached, hold the rail in place while releasing the button. Place the blind back into the window opening and the blind will stay in that position.

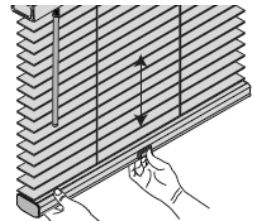

FOR LOWER THE BLINDS:

- Tilt the slats to the open position (flat and parallel to headrail).
- Prior to lowering the blind, fully press the center button with your thumb and pull the bottom rail down to the desired height while the button is fully depressed.
- Once the blind reaches the preferred position, hold it there while releasing the button and the blind will stay in that position.

FOR INSIDE MOUNT BLINDS:

When lowering the blind to the full-down position, pull the bottom rail down and slightly toward you, approximately 1" beyond the sill. Release the button, then lift and place the bottom rail up onto the sill.

## Motorized Shades

Prior to installing the shade, pair with the remote using the instructions included with the remote.

## TROUBLESHOOTING

### ALIGNING BLIND.

- For all blinds the ladders may become misaligned in transit. After installation tilt the blind opened and closed several times to allow the ladders and slats to align themselves.

### BOTTOMRAIL IS NOT LEVEL.

- **Lift & Lock Blinds** feature a skew adjuster also located in the bottom of the headrail.
  - To level the blind, raise the low side of the bottom rail by turning the screw adjustment feature on the headrail clockwise with a coin or screwdriver while lifting the weight from the bottom rail.

**NOTE:** Turn the skew adjustment that is on the same side as the low side of the bottom rail.

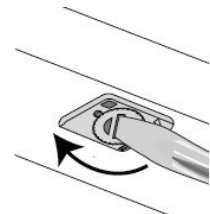

### BLIND HEIGHT IS TOO LONG.

- **Lift & Lock Blinds**, if the blind height is too long, turn all the skew adjustment features clockwise to raise the entire bottom rail to the desired height while lifting the weight from the bottom rail. There is an adjustment range of approximately 1-1/4".

## CARE AND CLEANING

**DUSTING:** Like any piece of furniture, dust your blinds regularly. Use an ordinary soft, clean cloth, chemically treated dust cloth, dusting mitt or cylindrical dust brushes especially designed for blinds. Lower the blind to its full length, tilt the slats almost fully closed and dust. Then dust the reverse side of the slats in the same manner. In order to reach the dust where the slats overlap, it is best not to fully close the blind in either position.

**VACUUMING:** To use your vacuum for cleaning your blind, use the brush attachment provide with your vacuum. Use the same procedure as mentioned above.

**DAMP CLEANING:** To wipe your blinds, use a soft cloth or sponge. Use warm or cold water - NOT hot water. Place toweling on the floor or sill and wipe the blind in sections.

**IMPORTANT NOTE:** Ultrasonic cleaning is NOT recommended for wood blinds.

## CHILD SAFETY

Young children can be **STRANGLERD** in cord loops and in the loop above the cord stop.

Always keep cords out of children's reach.

- Move cribs, playpens and other furniture away from cords. Children can climb furniture to get to cords.
- Do not tie cords together.
- Make sure cords do not twist together and create a loop.

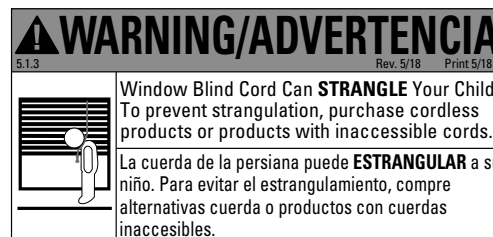

### SAFETY LABELS

In compliance with WCMA/ANSI safety standards the warning labels on the bottom rail are designed to be permanent. **DO NOT** remove the permanent warning label on the bottom rail. This assures that future owners of this product will be aware of potential dangers associated with this shade.

### CORD STOP

- This component breaks apart with minimal pressure should a child or pet become entangled in the top lift cords.
- It also acts as a stopper to prevent inner cords from being pulled through the blind, which can also create potential entanglement.

### Reassembly of Cord Stop

Reinsert any loose cords into the top notches of the cord stop. There is a notch on each side.

Line up the two halves of the cord stop and snap the pieces back together.

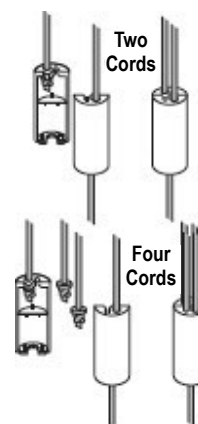

### CORD CLEATS

We recommend the use of cord cleats.

- Attach two cord cleats 6" to 12" apart at a height where they will be out of the reach of children. Take into account that a child may stand on furniture attempting to reach the cords.
- Be sure the cleats are firmly secured.
- Once the cleats are attached, wrap excess cord around them after each use of the blind.

**Cord Cleats are included with all blinds that have free hanging cords.**

